



2019

GRAF  TISAK

KATALOG

uredskog materijala



Misija tvrtke Grafotisak je ponuditi suvremeni oblik proizvodnje grafičkih proizvoda te distribuciju uredskog, školskog i grafičkog materijala uz proaktivno upravljanje novim tehnološkim dostignućima, a sve u svrhu zadovoljavanja potreba kupaca i njihovih interesa koji ih s nama povezuju.

Vizija tvrtke Grafotisak je u dogledno vrijeme postati prvim izborom u međunarodnim okvirima proizvodnje grafičkih proizvoda kroz učvršćivanje pozicije regionalnog lidera i izgradnju respektabilnosti na razini koja prelazi dosadašnje regionalne granice, te rad na kontinuiranom unapređenju djelatnosti distribucije i cjelokupnog poslovanja uz korektnost prema svim interesno utjecajnim skupinama.



TRGOVINA



- 4 prodajna centra
- preko 100 robnih marki
- 20.000 artikala
- 25.000 m² uredskog i skladišnog prostora

TRANSPORT



- 40 transportnih jedinica
- besplatna dostava
- isporuka unutar 24 sata u Bosni i Hercegovini



PROIZVODNJA



Artikli koje proizvodimo izrađeni su vrhunskom tehnologijom od najkvalitetnijih materijala, a njihovu kvalitetu je prepoznalo tržište cijele Europe.

KONTAKT



Kontaktirajte nas svakim radnim danom od 7:30-16:00 sati, a subotom od 7:30-12:00 sati

• Centrala Grude

Blage Zadre 26, 88340 Grude
Tel.: +387 39 660 222
Fax: +387 39 660 250
E-mail: grafotisak@grafotisak.com

• Podružnica Tuzla

Industrijska 14, 75000 Tuzla
Tel.: +387 35 320 350
Fax: +387 35 320 370
E-mail: gtgtu@grafotisak.com

• Podružnica Banja Luka

Knjaza Miloša 3C, 78000 Banja Luka
Tel.: +387 51 348 400
Fax: +387 51 348 410
E-mail: gtgbl@grafotisak.com

• Podružnica Sarajevo

Bojnička 41n, 71210 Ilidža, Sarajevo
Tel.: +387 33 773 380
Fax: +387 33 773 390
E-mail: gtgsa@grafotisak.com

KVALITETOM KROZ VRIJEME!

Kvaliteta je odgovornost.
Naše poslovanje je simbol odgovornosti!

ŠIROK ASORTIMAN

Nudimo više od 20.000 artikala, sve za ured i školu na jednom mjestu.

U ponudi imamo artikle poznatih svjetskih robnih marki, kao i vlastite robne marke: Connect, Educa, Fornax, Foroffice i Lipa Mill, vrhunske kvalitete po konkurentnim cijenama.



BRZA ISPORUKA

Besplatnu dostavu vršimo svakodnevno vlastitim prijevozom na adresu kupca. 4 prodajna mjesta na području Bosne i Hercegovine:

Grafotisak d.o.o. Grude, sjedište
Grafotisak d.o.o. Sarajevo, podružnica
Grafotisak d.o.o. Banja Luka, podružnica
Grafotisak d.o.o. Tuzla, podružnica

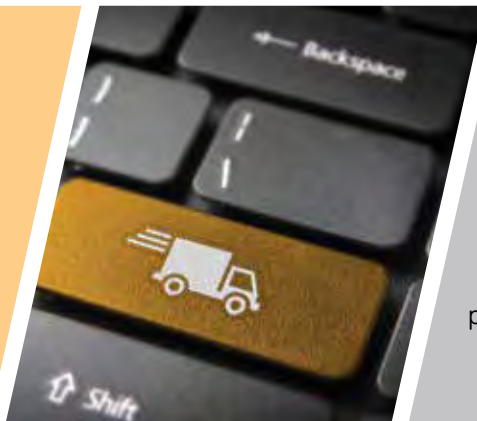

USLUŽNO OSOBLJE

Za sve Vaše upite na raspolaganju je tim sposobnih i ljubaznih zaposlenika, koji će Vam vrlo rado pomoći u odabiru onog što tražite.

ODGOVORNO UPRAVLJANJE - BRIGA ZA OKOLIŠ

Nositelj smo Certifikata ISO 9001:2015, ISO 14001:2015, ISO 45001:2018 i FSC™ CoC jer Vi zaslužujete najbolje.

Kontinuirano identificiramo i upravljamo aspektima okoliša, stvarajući pozitivni utjecaj na okoliš što između ostalog uključuje i proces razvrstavanja otpada i proces recikliranja.

U naš asortiman smo uvrstili artikle napravljene od recikliranog materijala ili su pogodni za reciklažu, koje možete vidjeti u katalogu označene zelenom bojom.



ZADOVOLJSTVO KUPACA

Grafotisak je svoje poslovne procese prilagodio kupcima.
Zadovoljstvo kupca je naš imperativ!

NAŠE ROBNE MARKE

Kao vodeći distributer i zastupnik uredskog materijala na domaćem tržištu, našim kupcima nudimo proizvode srednje i visoke klase, te u skladu s odgovarajućom kategorijom kvalitete za te proizvode jamčimo najbolje cijene. Uz proizvode uredskog materijala pod vlastitim robnim imenima, zastupamo i na tržištu nudimo najpoznatije svjetske marke.

Connect

Pod robnom markom Connect pronaći ćete školske artikle visoke kvalitete i modernog dizajna.



Educa

Educa robnu marku čine kvalitetni školski artikli po izuzetno povoljnim cijenama.

fornax

Bogati izbor artikala potrebnih u svakodnevnom uredskom poslovanju po pristupačnim cijenama.



foroffice

Izabrani uredski artikli po izuzetno pristupačnim cijenama.



Lipa Mill

Visokokvalitetni registratori prepoznatljivog dizajna.



ODGOVORNO UPRAVLJANJE: BRIGA ZA OKOLIŠ

U Grafotisku primjenjujemo i održavamo Integrirani sustav upravljanja kvalitetom, okolišem, zdravljem i sigurnosti na radu koji se temelji na zahtjevima postavljenim u međunarodnim standardima, i to kako slijedi:

- **ISO 9001:2015** – Sustavi upravljanja kvalitetom;
- **ISO 14001:2015** – Sustavi upravljanja okolišem;
- **ISO 45001:2018** – Sustavi upravljanja zdravljem i sigurnosti na radu.

Unutar Integriranog sustava upravljanja koji je dinamičan i sveobuhvatan, poseban naglasak stavljamo na okoliš, pri čemu su procesi i aktivnosti koji se svakodnevno odvijaju kontrolirani i uredno praćeni, a identifikacija i upravljanje aspektima okoliša jedna je od najvažnijih sastavnica.

Briga za okoliš i aktivnosti koje provodimo s ciljem stvaranja pozitivnog utjecaja na okoliš, između ostalog, uključuju i sam proces razvrstavanja otpada, kao i proces recikliranja.

U našem asortimanu je sve više artikala koji su nekim udjelom proizvedeni od recikliranog repromaterijala.

U katalogu možete vidjeti označene artikle koje ćete prepoznati kao ekološki prihvatljive.



Recikliranje je izdvajanje iskoristivih sastojaka iz otpada i njegovo ponovno korištenje.

Uključuje sakupljanje, izdvajanje, preradu i izradu novih proizvoda iz iskorištenih stvari ili materijala. Vrlo je važno odvojiti otpad prema vrstama sastojaka. Iskoristivost otpadnih materijala je veća ako su odvojeno sakupljeni.

Također, u Grafotisku implementiramo i održavamo Sustav upravljanja FSC™ lancem sljedivosti koji se temelji na zahtjevima postavljenim u međunarodnom standardu *Forest Stewardship Council™ Chain of Custody Certification*, FSC – STD – 40 – 004 V3 – 0.

Sustav upravljanja FSC™ lancem sljedivosti pokazatelj je povezanosti poslovne prakse i proizvoda, te odgovornih šumarskih poduzeća i krajnjih potrošača.

Uvodeći Sustav upravljanja FSC™ lancem sljedivosti, Grafotisak je pokazao svoju spremnost i obvezu upravljanja šumama s aspekta zaštite životne sredine i društvene odgovornosti, označavajući pritom svoje proizvode sa FSC™ logom, shodno zahtjevima kupca.

Unutar Sustava upravljanja FSC™ lancem sljedivosti, Grafotisak prati FSC™ certificirani materijal, kako u trgovini uredskim, školskim i grafičkim artiklima, tako i u proizvodnji grafičkih proizvoda s ciljem sustavnog provjeravanja porijekla drveta pri čemu su zadovoljeni svi zahtjevi kvalitete, porijekla drveta, kontrole proizvodnje i održavanja zapisa; zahtjevi za FSC™ proizvode i njihovo označavanje te zahtjevi dokumentiranja.



Podizanje svijesti o kvaliteti, zaštiti okoliša i zaštiti zdravlja i sigurnosti na radu u našoj radnoj okolini, među našim zaposlenicima i prema našim kupcima, poslovnim partnerima i društvu u cjelini dio je naše temeljne politike poslovanja.

Upute za korištenje kataloga radi lakšeg snalaženja

Vrsta proizvoda
koji se nalaze
na odabranoj
stranici

**Podjela
proizvoda**

**Preporučeni
artikli**

Informacija
pokazuje važne
i zanimljive
informacije o
proizvodu

Ikona
koja pokazuje
ekološki
prihvatljive
proizvode

Zelena podloga
naglašava
ekološki
prihvatljive
proizvode





Ikone
koje opisuju
tehničke
karakteristike

Boja grupe
radi lakšeg
snalaženja svaka
grupa ima svoju
boju

Šifra
proizvoda

Boja
proizvoda

Ikone koje koristimo u katalogu



Eko proizvodi



Informacija



Preporučeni artikli



Vidjeti na stranici

Naši sezonski katalogi



Vaše potrebe možete dopuniti kroz sezonske kataloge (Školski katalog i katalog Poklon program) kao i kroz katalog Grafičkog materijala i repromaterija



**RAZLIKA
IZMEĐU
PRITT STICKA I
SMOOTHIE-JA
JE SAMO 10%**



**90%
PRIRODNIH
SASTOJAKA***

*uključujući i vodu

Pritt ljepilo u stiku

Prvo ljepilo na svijetu koje je napravljeno od 90% prirodnih sastojaka, bazirano na jedinstvenoj kombinaciji krumpirovog škroba i šećera.

Prirodna snaga lijepljenja osigurava dugotrajnu stabilnost lijepljenih proizvoda!

Ljepila i korekturna sredstva Pritt čuvaju prirodu.

Henkel Croatia d.o.o., Budmanijeva 1, 10 000 Zagreb,
Tel: 01/6008 222, E-mail: ljepila@henkel.com

Henkel

Sadržaj

1	RAČUNALNI PRIBOR	13-38
2	UREDSKI APARATI	39-68
3	PAPIRI I PAPIRNA KONFEKCIJA	69-110
4	PISAĆI PRIBOR	111-186
5	UREDSKI MATERIJAL	187-250
6	ARTIKLI ZA ARHIVIRANJE	251-280
7	ARTIKLI ZA PREZENTACIJU	281-308
8	ARTIKLI ZA URED I KUĆANSTVO	309-344
9	PUTNI PROGRAM	345-370
10	ISPISNI POTROŠNI MATERIJAL	371-468

SADRŽAJ PO ABECEDNOM REDU

A		
Albumi za vizitke	279	
Aparati Dymo.....	61	
Aparati za otkrivanje lažnih novčanica	64	
Aparati za spiralni uvez.....	299	
Aparati za suho koričenje	305	
Aparati za termo uvez	306	
A-stalci.....	288	
Automati za pečate.....	231	
B		
Baterije.....	57	
Blu - Ray diskovi.....	15	
Bilježnice.....	102	
Blokovska roba.....	107	
Blokovi flipchart	289	
Blokovi kocke.....	93	
Blokovi notes.....	106	
Blokovi post-it.....	89	
Blokovi spirala.....	106	
Blokovi za crtanje.....	105	
Boje u spreju.....	329	
Boje suhe.....	143	
Boje tempera.....	183	
Boje vodene.....	184	
Boje voštane	181	
Brisači ploče.....	290	
Brisači tinte.....	128	
Brojači novca.....	65	
Brtvila.....	315	
Bušilice.....	212	
C		
CD mediji.....	14	
Celofani.....	337	
Č		
Čaše za olovke.....	239	
Čaše za spajalice.....	200	
Čaše za tempere.....	182	
Čavlići.....	291	
Četke za vrata	317	
D		
Datumari	235	
Debinderi.....	305	
Deklamerice.....	209	
Deklišeri.....	225	
Držači dokumenata.....	36	
Držači folije.....	327	
Držači krede.....	179	
Držači papira.....	304	
Držači traka samoljepljivih.....	193	
DVD mediji.....	16	
E		
Etikete Dymo	62	
Etikete samoljepljive za pisače.....	85	
Etikete u roli.....	88	
Etikete ukrasne	89	
Etiketirke.....	60	
Etui za akreditaciju	307	
Etui za dokumente.....	279	
Etui za vizitke	279	
F		
Fascikle arhivske	265	
Fascikle novinarske	267	
Fascikle papirne	262	
Fascikle "L"	273	
Fascikle "U".....	274	
Fascikle s dugmetom.....	267	
Fascikle s gumicom.....	262	
Fascikle s kliznim mehanizmom.....	261	
Fascikle s kočecim mehanizmom.....	261	
Fascikle s mehanizmom.....	258	
Fascikle s umetkom.....	275	
Fascikle sklopive.....	271	
Fascikle viseće	269	
Filc podlošci	316	
Finelineri.....	176	
Flomasteri.....	154	
Folije sa zračnim jastukom.....	84	
Folije stretch.....	327	
Folije za grafoskop.....	292	
Folije za plastifikaciju	298	
Folije za prekrivanje.....	313	
G		
Globusi	242	
Gumice za domaćinstvo	312	
Gumice.....	146	
H		
Heftarice.....	201	
I		
Indigo papiri.....	79	
Ink jet Brother.....	376	
Ink jet Canon	385	
Ink jet Dell.....	391	
Ink jet Epson.....	393	
Ink jet HP	406	
Ink jet Lexmark	440	
Ink jet Ricoh.....	449	
J		
Jamstvenici	278	
Jastučići za pečate.....	231	

SADRŽAJ PO ABECEDNOM REDU

K

Kajdanke	105
Kalkulatori	52
Kante za kišobrane.....	244
Kante za smeće.....	243
Karte igraće.....	310
Kase metalne.....	244
Katanci	245
Kistovi.....	184
Kišobrani.....	366
Kocke papirne.....	95
Korektori	129
Korice za uvez	306
Krede.....	179
Krep papiri.....	336
Krivuljari.....	249
Kutije arhivske.....	271
Kutije magnetne.....	200
Kutije za fascikle.....	270
Kutomjeri	249
Kuverte	80
Kuverte Writtech	79

L

Ladice za novac.....	66
Lampe stolne	243
Laserski pokazivači.....	292
Listovi uložni.....	276
Lupe	238

LJ

Ljepila.....	193
Ljepljivi jastučići.....	199

M

Magneti.....	289
Mape potpisne	277
Mape za likovno.....	105
Mape za projekte	278
Maramice	311
Markeri.....	258
Mehanizmi za fascikle	273
Memorijske kartice.....	27
Mikrofon.....	29
Mine za tehničku olovku.....	135
Miševi za računala	31
Mjerne trake u roli	327
Mreže za prozore	316
Municije za heftarice.....	209

N

Naliv pera.....	124
Naljepnice notarske.....	278
Neseseri	351

Notesi	100
Novčanici	357
Nož za poštu	221
Noževi za skalpel.....	221
Numeratori	237

O

Odmarači za leđa, noge i zglobove	33
Odstranjivači ljepila.....	198
Okovratnici	307
Okviri za slike	245
Okviri zidni.....	286
Olovke kemijske	113
Olovke suhe.....	138
Olovke tehničke.....	133
Omoti za CD/DVD.....	19
Ormarići za ključeve.....	245
Ormarići za spise	241
Označivači samoljepljivi.....	96

P

Palete za likovno.....	182
Papiri fotokopirni bijeli	70
Papiri fotokopirni u boji.....	73
Papiri kompjuterski	77
Papiri multi.....	72
Papiri paus.....	78
Papiri photo.....	74
Papiri u roli za kopiranje.....	77
Papiri toaletni.....	311
Papir ukrasni.....	333
Papir Writtech.....	76
Papiri za ploter.....	76
Papir zaštitni.....	314
Patrone za naliv pero	127
Pištolji za lijepljenje.....	330
Plastifikatori	295
Platna za projekciju	291
Podlistovi	305
Podloge za miša i tipkovnicu.....	32
Podlošci gumeni.....	230
Poklon setovi	365
Poklon vrećice.....	341
Polica za spise.....	240
Postolje za laptop	36
Postolje za monitor	36
Predlistovi	304
Prijenosni diskovi.....	20
Primeri u spreju.....	329
Privjesci	245
Punjači.....	59
Punjenja za 3D pisač.....	373

SADRŽAJ PO ABECEDNOM REDU

R

Rafije	331
Rajsngle.....	313
Rapidografi.....	178
Ravnala.....	247
Refili.....	128
Registratori.....	252
Remeni	363
Riboni.....	466
Role ading.....	78
Role magnetne.....	327
Role telefax.....	78
Roleri.....	120
Rukavice	362
Ruksaci za laptop.....	349

S

Salvete.....	311
Setovi geometrijski.....	249
Setovi pisači.....	115
Setovi uredski.....	238
Signiri.....	150
Skalpeli.....	219
Skupljači vlage.....	312
Slušalice.....	28
Spajalice.....	200
Spirale metalne.....	303
Spirale PVC.....	303
Spužve nakvasne.....	238
Sredstva za čišćenje.....	36
Stalci za olovke.....	239
Stalci za spise.....	240
Stolnjaci.....	311

Š

Šestari.....	246
Šiljila.....	149
Škare.....	223
Špage.....	331
Špiode.....	313
Štipaljke za papir.....	199

T

Table piši briši.....	282
Table pluto.....	290
Table za tehničko crtanje.....	246
Telefoni.....	59
Tinte pečatne.....	237
Tinte za nalivpero.....	127
Tinte za rapidografe.....	178
Tipkovnice.....	30
Toneri Brother.....	374
Toneri Canon.....	378
Toneri Dell.....	391

Toneri Epson.....	392
Toneri HP.....	400
Toneri Konica Minolta.....	422
Toneri Kyocera.....	426
Toneri Lexmark.....	428
Toneri Oki.....	443
Toneri Panasonic.....	446
Toneri Ricoh.....	448
Toneri Samsung.....	452
Toneri Toshiba.....	449
Toneri Xerox.....	454
Torbe kožne.....	352
Torbe za laptop.....	346
Torbe za table.....	246
Trake aluminijske.....	325
Trake armirane.....	325
Trake elektroizolacijske.....	325
Trake ljepljive.....	188
Trake ljepljive nevidljive.....	188
Trake ljepljive pakirne.....	189
Trake ljepljive vodootporne.....	326
Trake obostrano ljepljive.....	323
Trake protuklizne.....	326
Trake upozoravajuće.....	191
Trake zaštitne.....	322
Trokutovi.....	249
Tube za projekte.....	278

U

Ubrusi.....	311
Ulje za uništivače.....	52
Uništivači papira.....	41
USB stikovi.....	22

V

Valjci tintni.....	60
Vješalice.....	318
Vosak pečatni.....	279
Vrećice za otpatke.....	310
Vrećice papirne.....	310
Vrećice sigurnosne.....	85
Vrećice sa zip zatvaračem.....	85
Vrećice treger.....	310
Vrećice za dokumente.....	85
Vrpce ukrasne.....	332

W

Web kamere.....	29
-----------------	----

Z

Zadačnice.....	105
Z-blokovi samoljepljivi.....	92
Zvučnici.....	29



Računalni pribor



Verbatim



CD-R AZO Crystal

- idealan za dijeljenje računalnih podataka, kućnih videa, fotografija i glazbe
- vrhunska otpornost na UV zračenje
- kapacitet: 700MB; brzina: 52x
- vrsta pakiranja: Spindle 25
- šifra: **000015882**



Verbatim

CD-R Printable

- idealan za snimanje videa, fotografija, glazbe, filmova...
- vrhunska otpornost na UV zračenje
- direktan ispis s printera na CD



PRINTABLE DISC

Printabilni diskovi su idealni za dijeljenje računalnih podataka, kućnih videa, fotografija i glazbe. Pokazuju visok stupanj kompatibilnosti između pogona koji rade na različitim brzinama. Vrhunska otpornost na UV zračenje, najniža stopa pogreški među CD/DVD pisačima. Gornja ploha diska omogućuje personaliziranje Vaših snimljenih CD/DVD-ova. Printabilni disk ima bijelu površinu za ink jet ispis, područje ispisa je od 23-118 mm.



Šifra	Kapacitet	Brzina	Vrsta pakiranja
000029415	700MB	52x	Wrap 50
000033208	700MB	52x	Spindle 50
000015881	700MB	52x	Spindle 25
000004388	700MB	52x	Jewel 10



Verbatim



CD-R High Capacity

- vrhunska otpornost na UV zračenje
- najniža stopa pogreški među CD pisačima
- kapacitet: 800MB; brzina: 40x
- vrsta pakiranja: Jewel 10
- šifra: **000015903**

Verbatim

CD-R Extra Protection

- površina s dodatnom zaštitom
- idealan za snimanje kućnih videa, fotografija, glazbe, filmova...
- vrhunska otpornost na UV zračenje



Šifra	Kapacitet	Brzina	Vrsta pakiranja
000015873	700MB	52x	Spindle 100
000015883	700MB	52x	Spindle 50
000029167	700MB	52x	Wrap 50
000012773	700MB	52x	Spindle 25
000015880	700MB	52x	Spindle 10
000015885	700MB	52x	Slim 10
000006733	700MB	52x	Slim 1 (200 pak.)



* **AZO** - Vrhunska otpornost na UV zrake za povećanu zaštitu i pouzdanost. Visoka kvaliteta slike i zvuka s više od 100 godina arhivskog trajanja.

EXTRA PROTECTION - Posebna zaštita od oštećenja.

CRYSTAL - Otporan, čisti površinski sloj za povećanu zaštitu protiv slučajnog oštećenja površine.

Spindle - pakiranje na štapu. **Slim** - pakiranje u tankoj kutiji. **Jewel** - pakiranje u debeloj kutiji. **Wrap** - pakiranje u foliji.

Verbatim**CD-R Colour Vinyl**

- u obliku gramofonske ploče
- kapacitet: 700MB; brzina: 52x
- vrsta pakiranja: Slim 10
- šifra: **000015887**

**Verbatim****CD-R Music**

- kapacitet: 80 minuta
- kapacitet: 700MB; brzina: 16x
- vrsta pakiranja: Jewel 10
- šifra: **000009837**

**Verbatim****CD-RW Hi-Speed Colour**

- namijenjen za višestruko pisanje i brisanje
- može zapisivati najmanje 1000 puta



Šifra	Kapacitet	Brzina	Vrsta pakiranja
000012782	700MB	8-12x	Spindle 10
000007794	700MB	8-12x	Jewel 10

Verbatim**CD-RW Hi-Speed Colour**

- namijenjen za višestruko pisanje i brisanje
- 5 različitih boja CD-ova
- kapacitet: 700MB; brzina 8-12x
- vrsta pakiranja: Slim 5
- šifra: **000015892**



BLU-RAY MEDIJI

**Verbatim****Blu-ray Disc BD-RE**

- 3-5 puta veći kapacitet pohrane od standardnih DVD diskova
- zaštitni sloj od tvrdog premaza
- vrlo dug arhivski vijek trajanja
- kapacitet: 25GB
- brzina: 6x
- vrsta pakiranja: Spindle 10
- šifra: **000032953**

Verbatim**Blu-ray Disc BD-RE**

- 3-5 puta veći kapacitet pohrane od standardnih DVD diskova
- zaštitni sloj od tvrdog premaza
- vrlo dug arhivski vijek trajanja
- kapacitet: 25GB
- brzina: 2x
- vrsta pakiranja: Jewel 5
- šifra: **000015908**



* **HARD COAT** - Posebno napravljen otporan premaz za DVD medije koji je iznimno otporan na ogrebotine. Da bi se zaštitili od potencijalnih oštećenja, Verbatimovim DVD-ovima pridonosi "Hard Coat" zaštitni sloj. Ovaj sloj štiti od otisaka prstiju, prašine, ogrebotina, statike i vode.



M•A•B•L - Metalni ablativni sloj za snimanje. Posebno napravljen neorganski sloj za snimanje predstavljen na Verbatimovom BD-R mediju, osigurava izvrsnu kompatibilnost snimanja i produženu stabilnost životnog vijeka arhive.



SERL - Posebni sloj za snimanje predstavljen na Verbatimovim CD-RW i DVD/RW medijima koji osigurava snimanje bez buke uvijek iznova. S Verbatimovim medijem za ponovni upis sloj za snimanje vraća se u savršeno stanje nakon svakog ciklusa brisanja, ostavljajući savršen disk za sljedeće snimanje. SERL također omogućuje ovom mediju uživanje prednosti izvrsne arhivske stabilnosti i snimanja velikom brzinom.

Spindle - pakiranje na štupu. **Slim** - pakiranje u tankoj kutiji. **Jewel** - pakiranje u debeloj kutiji. **Wrap** - pakiranje u foliji.



BLU-RAY DISC



Pronalazak tehnologije Blu-ray je doveo do nastanka diskova velikog kapaciteta, kako bi se zadovoljila potražnja nastala zbog brzog širenja televizije visoke definicije (HDTV).

Blu-ray diskovi su ime dobili po tehnologiji plavih lasera. Laser je plave boje zbog kraće talasne dužine laserskog snopa. Talasna dužina plavog lasera je 405 nm, u poređenju sa talasnom dužinom DVD tehnologije od 650 nm, jer ona koristi crveni laser. Prednost plavog lasera sa kraćom talasnom dužinom je u tome što on omogućava pisanje manjih rupa sa podacima, čime se značajno povećava količina podataka na disku.

Blu-ray diskovi nude od 3 do 5 puta veći kapacitet od standardnog DVD-a, što omogućava rezanje, brisanje i reprodukciju video snimaka visoke definicije (HD).

Koristiti samo u uređajima i rezačima koji podržavaju Blu-ray diskove bez kertridža.



DUAL LAYER DISC

Verbatimovi dvoslojni diskovi nude veliki kapacitet pohrane od 8,5 GB (2,6 za proizvode od 8 cm). Dvoslojno snimanje omogućeno je stvaranjem novog zamjenskog sloja koji se nalazi između svakog sloja za snimanje te laseru omogućuje snimanje na oba sloja. Nakon što je snimljeno na prvi sloj, laser se usmjerava na drugi sloj i snima.

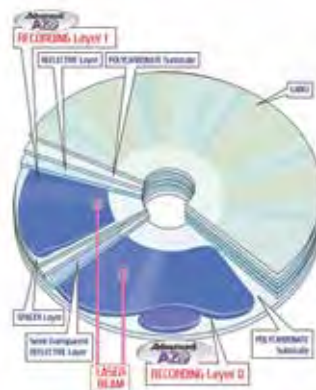

Verbatim

Blu-ray Disc BD-RE DL

- 3-5 puta veći kapacitet pohrane od standardnih DVD diskova
- s dvostrukim slojem za snimanje
- kada je snimljen prvi sloj, laser snima drugi sloj
- zaštitni sloj od tvrdog premaza
- vrlo dug arhivski vijek trajanja
- kapacitet: 50GB
- brzina: 2x
- vrsta pakiranja: Jewel 5
- šifra: **000024404**

DVD MEDIJI

Verbatim

DVD+R Matt Silver

- s najvišom razinom stabilnosti snimanja
- sjajna srebrna površina



Šifra	Kapacitet	Brzina	Vrsta pakiranja
000012794	4.7GB	16x	Spindle 100
000022511	4.7GB	16x	Spindle 50
000015898	4.7GB	16x	Spindle 25
000009833	4.7GB	16x	Spindle 10



Spindle - pakiranje na štapu. Slim - pakiranje u tankoj kutiji. Jewel - pakiranje u debeloj kutiji. Wrap - pakiranje u foliji.



DVD+R Printable

- direktan ispis s printera na DVD
- s najvišom razinom stabilnosti snimanja
- sjajna srebrna površina
- kapacitet: 4.7GB; brzina: 16x
- vrsta pakiranja: Jewel 10
- šifra: **000009839**



DVD+R Double Layer Printable

- direktan ispis s printera na DVD
- s dvostrukim slojem za snimanje
- kad je snimljen prvi sloj laser snima drugi sloj
- kapacitet: 8.5GB; brzina: 8x
- vrsta pakiranja: Spindle 25
- šifra: **000015900**



DVD+R Double Layer

- s dvostrukim slojem za snimanje
- kad je snimljen prvi sloj laser snima drugi sloj



Šifra	Kapacitet	Brzina	Vrsta pakiranja
000015918	8.5GB	8x	Spindle 10
000015899	8.5GB	8x	Jewel 5



DVD-R Printable

- direktan ispis s printera na DVD
- s najvišom razinom stabilnosti snimanja
- sjajna srebrna površina



Šifra	Kapacitet	Brzina	Vrsta pakiranja
000001772	4.7GB	16x	Spindle 25
000009505	4.7GB	16x	Jewel 10



DVD-R Matt Silver

- s najvišom razinom stabilnosti snimanja
- sjajna srebrna površina



Šifra	Kapacitet	Brzina	Vrsta pakiranja
000018194	4.7GB	16x	Spindle 100
000015869	4.7GB	16x	Spindle 50
000015893	4.7GB	16x	Spindle 25
000001757	4.7GB	16x	Spindle 10
000015870	4.7GB	16x	Slim 1
000009831	4.7GB	16x	Jewel 5





Verbatim



DVD-R Colour

- dostupno u 5 boja: roza, narančasta, ljubičasta, plava i zelena
- kapacitet: 4.7GB; brzina: 16x
- vrsta pakiranja: Slim 5
- šifra: **000015894**



Verbatim



DVD+RW Colour

- dostupan u 5 boja
- kapacitet: 4.7GB; brzina: 4x
- vrsta pakiranja: Slim 5
- šifra: **000015901**



Verbatim

DVD+RW Matt Silver

- disk s mogućnošću ponovnog snimanja
- koristi super sloj za snimanje
- vrhunski arhivski vijek trajanja



Šifra	Kapacitet	Brzina	Vrsta pakiranja
000009835	4.7GB	4x	Spindle 10
000000444	4.7GB	4x	Jewel 5



Verbatim



DVD-RW Matt Silver

- DVD-RW mediji mogu biti presnimljeni više od 1000 puta
- za snimanje videa i prijenos aplikacija za izradu sigurnosnih kopija
- vrhunski arhivski vijek trajanja
- kapacitet: 4.7GB; brzina: 4x
- vrsta pakiranja: Jewel 5
- šifra: **000015871**

Markeri za CD/DVD



VIDJETI NA STR. 165

edding



Verbatim

DVD-R 8cm

- direktan ispis s printera na DVD
- mini DVD disk koristi se u većini slučajeva za video kamere
- rezultira velikom kvalitetom snimanja i osigurava dulje vrijeme arhiviranja
- kapacitet: 1.4GB; brzina: 4x
- vrsta pakiranja: Jewel 5
- šifra: **000015895**



Spindle - pakiranje na štapu. **Slim** - pakiranje u tankoj kutiji. **Jewel** - pakiranje u debeloj kutiji. **Wrap** - pakiranje u foliji.



Verbatim

DVD-RW Matt Silver 8cm

- mini DVD namjenjen za video kamere
- DVD-RW mediji mogu biti presnimljeni do 1000 puta
- kapacitet: 1.4GB
- brzina: 2x
- vrsta pakiranja: Jewel 5
- šifra: **000015910**



Verbatim

DVD-R Dual Layer 8cm

- namjena za video kameru
- kapacitet: 2.6GB
- brzina: 4x
- vrsta pakiranja: Jewel 5
- šifra: **000015912**



Verbatim

DVD+RW Matt Silver 8cm

- namjena za video kameru
- kapacitet: 1.4GB; brzina: 4x
- vrsta pakiranja: Jewel 5
- šifra: **000015902**



OMOTI I KUVERTE ZA CD/DVD MEDIJE



Verbatim

Omot za CD

- za organizaciju i zaštitu CD/DVD-ova
- bijeli papirni omot s prozorom od prozirne folije
- dimenzije 126x126 mm
- pakiranje: 50/1
- šifra: **000012904**

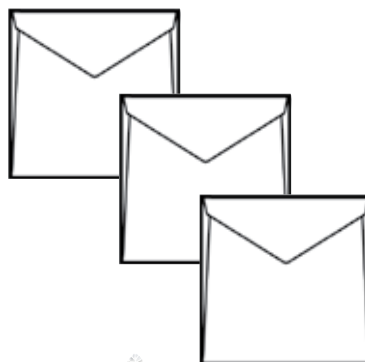

Omot za CD

- za organizaciju i zaštitu CD/DVD-ova
- bijeli papirni omot
- dimenzije 126x126 mm
- pakiranje: 1000/1
- šifra: **000016394**



Kuverta sa zračnim jastukom

- koristi se za slanje CD/DVD-ova
- način ljepljenja: strip
- dimenzija: 180x200 mm
- pakiranje: 100
- šifra: **000019461**



ETIKETE ZA CD/DVD MEDIJE

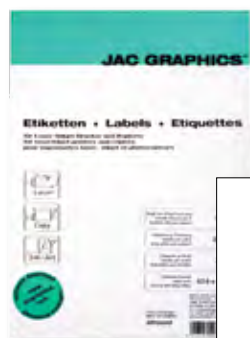

Jac

Samoljepljive etikete

- za personalizaciju CD/DVD-a putem pisača
- format A4/2
- pakiranje: 100 kom
- šifra: **000009406**

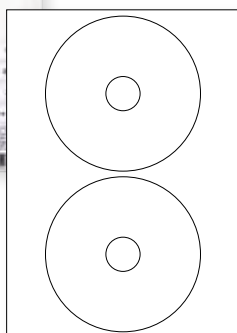

fornax

Samoljepljive etikete

- za personalizaciju CD/DVD-a putem pisača
- format A4/2
- pakiranje: 100 kom
- šifra: **000017937**

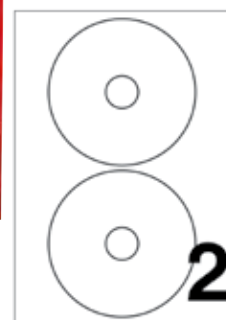

Ø117 mm



Prijenosni tvrdi disk Store'n'Go 2.5" 3.0

- Store'n'Go prijenosni tvrdi diskovi su formatirani u FAT32 što omogućava da ih koristite u Windows OS, Linux i Mac OS sustavima
- sučelje: USB 3.0
- 100% kompatibilan sa USB 2.0
- brzina prijenosa podataka do 4800 Mbit/s
- brzina vrtnje 5400 o/min
- kapacitet: 2TB
- masa: 150 gr
- dimenzija: 80x116x13 mm
- šifra: **000024843**



Prijenosni tvrdi disk Store'n'Go 2.5" 3.0

- Store'n'Go prijenosni tvrdi diskovi su formatirani u FAT32 što omogućava da ih koristite u Windows OS, Linux i Mac OS sustavima
- sučelje: USB 3.0
- brzina prijenosa podataka: 4800 Mbit/s
- jednostavno prenosite dokumente i podatke između doma i ureda
- izrađujte sigurnosne kopije i pohranjujte sve datoteke s vašeg osobnog ili prijenosnog računala
- USB plug 'n' play (nije potrebno dodatno napajanje)
- stilski tanki dizajn

Šifra	Boja	Kapacitet	Masa (gr)	Dimenzija (mm)
000016878	srebrna	500GB	135	121x80x15
000021244	crna	500GB	135	121x80x15
000021250	srebrna	1TB	184	121x80x15
000020637	crna	1TB	184	121x80x15



Prijenosni tvrdi disk Store 'n' Go USB 3.0

- napajanje preko USB 3.0 kabla
- sučelje: USB 3.0 / 2.0 ulaz
- brzina prijenosa podataka: do 4800 Mbita/sekundi
- privremena memorija: 8MB ili veća

Šifra	Boja	Kapacitet	Dimenzija (mm)
000027027	crna	500GB	119x81x14.5
000027212	srebrna	500GB	119x81x14.5
000027028	crna	1TB	119x81x14.5
000027029	srebrna	1TB	119x81x14.5

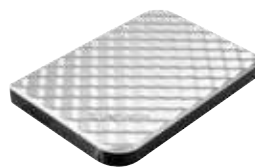



Prijenosni tvrdi disk Store 'n' Save

- sučelje: USB 3.0
- kompatibilan s Windows 7/8/10, Mac OS X
- izrađujete sigurnosne kopije i pohranjujete sve datoteke s vašeg osobnog ili prijenosnog računala
- USB plug 'n' play (nije potrebno dodatno napajanje)

DO
10x
BRZI OD
STANDARD
USB 2.0

Šifra	Kapacitet	Masa (gr)	Dimenzija (mm)
000030287	2TB	1000	192x118x49
000030288	3TB	1000	192x118x49



Prijenosni tvrdi disk SSD Vx500

- s USB-C i USB-A kablovima
- USB 3.1 Gen2
- kompatibilan s Windows 7/8/10, Mac OS X
- brzina čitanja do 500MB/s, a pisanja do 440MB/s
- aluminijско kućište
- sigurnosno kopiranje velikih količina digitalnih podataka



Šifra	Kapacitet	Masa (gr)	Dimenzija (mm)
000032992	120GB	29	92x29x9
000032993	240GB	29	92x29x9
000032994	480GB	29	92x29x9





USB Memory Stick Store'n'Go PinStripe 2.0

- lagan, s prugastim pinstripe dizajnom
- savršeno rješenje za pohranu
- ima mogućnost kliznog povlačenja koja štiti USB priključak kad se ne koristi
- masa: 7,9 gr

Šifra	Kapacitet	Brzina čitanja	Brzina pisanja	Dimenzija (mm)
000015991	16 GB	10MB/Sec	4MB/Sec	54x21x9,22
000015992	32 GB	10MB/Sec	4MB/Sec	54x21x9,22
000021059	64 GB	10MB/Sec	4MB/Sec	54x21x9,22



USB Memory Stick PinStripe

- USB 3.0 super brzo sučelje
- klizni mehanizam štiti USB priključak kada pogon nije u uporabi
- masa: 7 gr

Šifra	Kapacitet	Dimenzija (mm)
000030858	16 GB	55x19x7
000030857	32 GB	55x19x7
000030856	64 GB	55x19x7
000030855	128 GB	55x19x7
000030854	256 GB	55x19x7





Verbatim

USB Memory Stick Slider 2.0

- USB 2.0
- ima mogućnost kliznog povlačenja koja štiti USB
- masa: 8 gr



Šifra	Kapacitet	Brzina čitanja	Brzina pisanja	Dimenzija (mm)
000032979	16 GB	10MB/Sec	4MB/Sec	58x21x11
000030294	32 GB	10MB/Sec	4MB/Sec	58x21x11
000032980	64 GB	10MB/Sec	4MB/Sec	58x21x11

Verbatim

USB Memory Stick Slider 2.0

- u pakiranju dolaze 2 USB (crveni i plavi)
- USB 2.0
- ima mogućnost kliznog povlačenja koja štiti USB



Šifra	Kapacitet	Brzina čitanja	Brzina pisanja	Dimenzija (mm)
000033507	32 GB	10MB/Sec	4MB/Sec	58x21x11



Verbatim

V3 USB Memory Stick Store'n'Go 3.0

- USB 3.0 super brzo sučelje
- mehanizam "povuci i zaključaj" štiti USB priključak kada pogon nije u uporabi
- kompaktan i elegantan dizajn
- masa: 10 gr



Šifra	Kapacitet	Brzina čitanja	Brzina pisanja	Dimenzija (mm)
000020452	16 GB	60MB/Sec	12MB/Sec	58x20x11
000020453	32 GB	80MB/Sec	25MB/Sec	58x20x11
000030847	64 GB	80MB/Sec	25MB/Sec	58x20x11
000022980	128 GB	80MB/Sec	25MB/Sec	58x20x11
000027571	256 GB	80MB/Sec	25MB/Sec	58x20x11

Verbatim

USB Memory V3 Max

- USB 3.0 super brzo sučelje
- mehanizam "povuci i zaključaj" štiti USB priključak kada pogon nije u uporabi
- masa: 10 gr

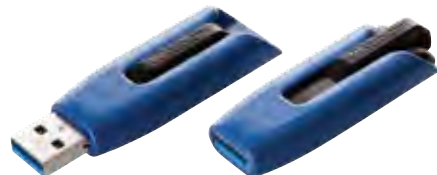

Šifra	Kapacitet	Brzina prijenosa podataka	Dimenzija (mm)
000032294	32 GB	400MB/s	58x20x11
000032293	64 GB	400MB/s	58x20x11
000032981	128 GB	400MB/s	58x20x11

Verbatim

USB Memory Swivel

- USB 2.0 brzo sučelje
- zakretni poklopac štiti USB priključak
- masa: 7 gr



Šifra	Kapacitet	Brzina čitanja	Brzina pisanja	Dimenzija (mm)
000032296	16 GB	8MB/s	2,5MB/s	52x17,5x10
000027892	32 GB	8MB/s	2,5MB/s	52x17,5x10
000027893	64 GB	8MB/s	2,5MB/s	52x17,5x10
000033582	128 GB	8MB/s	2,5MB/s	52x17,5x10

Verbatim

USB Memory Stick Clip-it 2.0

- flash memorija s dizajnom spajalice
- ovaj dizajn je nagrađen Red Dot-ovom nagradom "Najbolje od najboljeg"
- prvi je USB pogon koji se može koristiti kao spajalice
- brzina čitanja do 10MB/s, a brzina pisanja do 3MB/s
- dimenzije: 36x4,5x12,4 mm
- masa: 2 gr
- kapacitet: 16 GB
- šifra: 000032301



USB STIKOVI



Verbatim

USB Memory Store'n'Stay

- USB 3.0 super brzo sučelje
- idealan za netbookove, ultrabookove i audio uređaje
- masa: 3 gr

Šifra	Kapacitet	Brzina čitanja	Brzina pisanja	Dimenzija (mm)
000032300	16 GB	80MB/s	25MB/s	18x16x7,8
000032299	32 GB	80MB/s	25MB/s	18x16x7,8
000032298	64 GB	80MB/s	25MB/s	18x16x7,8



Verbatim

USB Memory Stick Dual

- vam omogućuje prijenos datoteka između računala i pametnog telefona, tableta ili bilo kojeg OTG (on the go) kompatibilnog uređaja
- pristup pohranjenom sadržaju izravno s Dual USB Flash diska
- nema potrebe za prijenosom datoteka i korištenjem memorijskog prostora na mobilnom uređaju
- radi bez Wifi-a i podatkovne veze

Šifra	Kapacitet	Masa (gr)	Dimenzija (mm)
000029016	16 GB	3	34x19x7
000032986	32 GB	3	34x19x7
000032987	64 GB	3	34x19x7



PUNJAČ ZA MOBITEL

Verbatim

Punjač Pocket Power Pack

- za punjenje pametnih telefona i tableta
- LED indikator napajanja, ugrađena lampa
- životni vijek: 500 punjenja
- uključen USB kabel za punjenje
- kapacitet baterije: 5.200 mAh, Li-Ion
- dimenzije: 72x54,5x21 mm
- vrijeme punjenja: 5-6 sati
- vrijeme djelovanja: 4-5 sati
- pakiranje: 1
- šifra: **000032191**





Punjač Pocket Power Pack

- za punjenje pametnih telefona i tableta
- LED indikator napajanja
- baterija: 10400 mAh, litij-ionska
- ulazni napon (mikro USB): DC 5,0 - 5,5 V
- ulazna struja: 2000 mA
- izlazni napon (USB): DC 5,0 V
- izlazna struja: 1000/2400 mA
- dimenzije: 105x72x22 mm
- težina proizvoda: 253 gr
- radni ciklus baterije: 500 puta
- vrijeme punjenja: 7-8 sati
- vrijeme rada: 4-5 sati
- pakiranje: 1
- šifra: **000032996**



Punjač Pocket Power Pack

- za punjenje pametnih telefona i tableta
- LED indikator napajanja
- baterija: 13000 mAh, litij-ionska
- ulazni napon (mikro USB): DC 5,0 - 5,5 V
- ulazna struja: 2000 mA
- izlazni napon (USB): DC 5,0 V
- izlazna struja: 1000/2400 mA
- dimenzije: 120x72x21 mm
- težina proizvoda: 306 gr
- radni ciklus baterije: 500 puta
- vrijeme punjenja: 9-10 sati
- vrijeme rada: 4-8 sati
- pakiranje: 1
- šifra: **000032997**



MEMORIJSKE KARTICE



SDHC Memorijska kartica Class 10

- Class 10 znači da je zajamčena minimalna brzina prijenosa podataka od 80Mbit/s
- za uporabu u digitalnim foto aparatima, prenosivim uređajima za reprodukciju glazbe, kamerama, pametnim telefonima i računalima
- koristi FAT32 sustav datoteka
- sa zaštitom od slučajnog brisanja podataka



Šifra	Kapacitet	Brzina čitanja	Brzina pisanja
000024856	8GB	10MB/Sec	10MB/Sec
000024855	16GB	10MB/Sec	10MB/Sec
000024854	32GB	10MB/Sec	10MB/Sec





MEMORIJSKE KARTICE

SDXC (klasa 10) - Memorijske kartice SecureDigital eXtended Capacity (SDXC) su napravljene tako da rade s velikom količinom podataka na velikim brzinama te omogućavaju fotografima da snime više slika visoke rezolucije po sekundi. Verbatimove SDXC memorijske kartice su kompatibilne s poslužiteljima koji sadrže najnoviju SDXC tehnologiju. Specifikacija klase 10 označava minimalne brzine prijenosa podataka od 10MB/Sec.

SDHC (klasa 10) - Memorijske kartice SecureDigital High Capacity (SDHC) imaju veći kapacitet i veće brzine prijenosa podataka od Secure Digital memorijskih kartica što ih čini idealnim i za profesionalne i za amaterske fotografe. Specifikacija Klase 10 označava minimalnu brzinu protoka podataka od 10 MB/sek, što Verbatimove SDHC memorijske kartice (Klase 10) čini idealnim za uporabu u SDHC kompatibilnim digitalnim foto-aparatima i video kamerama, kao i drugim SDHC uređajima na kojima je SDHC logotip.

SDHC (klasa 4) - Memorijske kartice SecureDigital High Capacity (SDHC) imaju veći kapacitet i veće brzine prijenosa podataka od Secure Digital memorijskih kartica što ih čini idealnim i za profesionalne i za amaterske fotografe. Verbatimove SDHC memorijske kartice su kompatibilne s uređajima koji imaju SDHC logotip. Specifikacija klase 4 označava minimalne brzine prijenosa podataka od 4MB/Sec.

Micro SDXC Memorijska kartica s adapterom

- Class 10 znači da je zajamčena minimalna brzina prijenosa podataka od 10MB/s
- dizajnirana tako da radi s velikom količinom podataka na velikim brzinama
- za uporabu u kamerama, tabletima, mobilnim telefonima
- kompatibilna s Windows XP/Vista i novim sustavima



Šifra	Kapacitet	Brzina čitanja	Brzina pisanja
000033008	16 GB	10MB/Sec	10MB/Sec
000033007	32 GB	10MB/Sec	10MB/Sec
000032292	64 GB	10MB/Sec	10MB/Sec
000032291	128 GB	10MB/Sec	10MB/Sec

Micro SDHC Memorijska kartica Class 10

- Class 10 znači da je zajamčena minimalna brzina prijenosa podataka od 80Mbit/s
- trenutno najmanji oblik memorijske kartice
- posebno dizajnirana za mobilne telefone
- također se može koristiti za GPS uređaje, MP3 čitače, digitalne kamere i dlanovnike



Šifra	Kapacitet	Brzina pisanja	Brzina čitanja
000024861	8GB	10MB/Sec	10MB/Sec
000024860	16GB	10MB/Sec	10MB/Sec
000024859	32GB	10MB/Sec	10MB/Sec

Verbatim**Slušalice Micro sa zvučnom izolacijom**

- iznimno maleni silikonski jastučići za udobnost
- dolazi s tri veličine jastučića za uho
- idealne za iPod, iPad, pametne telefone...
- raspon frekvencije: 20Hz - 20KHz
- osjetljivost: 96dB
- duljina kabela: 1,2 m
- masa: 12 grama
- šifra: **000024629**

**Genius****Slušalice HS-02B**

- HS-02B slušalice su s mekanim spužvastim jastučićima za uho koje možete nositi s udobnošću
- mikrophon s kontrolom glasnoće na kabelu čini vaš glas mnogo jasnijim
- šifra: **000011069**

**Genius****Slušalice HS-200C**

- s rotirajućim mikrofonom
- mekani spužvasti jastučići za uho
- šifra: **000028784**

**Genius****Slušalice HS-300N**

- s mikrofonom
- sklopive
- dužina kabela: 1,80 m
- frekvencija: 20Hz-20kHz
- šifra: **000019865**

**Genius****Slušalice HS-400A**

- s rotirajućim mikrofonom
- kontrola jačine zvuka
- frekvencije: 20Hz - 20KHz
- osjetljivost: 102dB
- duljina kabela: 1,8 m
- šifra: **000028785**

**Genius****Slušalice HS-04SU**

- s mikrofonom koji poništava šum
- izvrsne za MSN, Skype i MP3 player
- mikrophon s kontrolom glasnoće na kabelu
- šifra: **000019864**

**Genius****Slušalice HS-05A**

- ergonomski oblik
- raspon frekvencije: 20Hz ~ 20KHz
- dužina kabela: 1,8 metra
- mikrophon s kontrolom glasnoće na kabelu
- šifra: **000033553**



MIKROFON



Mikrofon MIC-05A

- frekventni odziv: 100 Hz - 10 kHz
- osjetljivost (na 1kHz): -48dB do 3dB
- duljina kabela: 1,8m
- pakiranje: 1
- šifra: **000027068**



ZVUČNICI



Zvučnici SP-U120

- aktivni crni stereozvučnici s kontrolom glasnoće i priključkom za slušalice.
- s USB priključkom
- raspon frekvencije: 160Hz - 20kHz
- izlazna snaga: 3 watt
- dimenzije: 66x174x78 mm
- masa: 470 g
- pakiranje: 1
- šifra: **000029171**



Zvučnici SP-U115

- modernog izgleda sa sjajnom prednjom stranom
- s USB priključkom
- kontrola glasnoće
- raspon frekvencije: 200Hz - 18kHz



Šifra	Boja	Pakiranje
000019872	plava	1
000019871	crvena	1

WEB KAMERA



Web kamera FaceCam 1000X

- omogućuje komuniciranje preko Interneta
- opremljen je sa 720p HD
- digitalni zoom 3X
- dimenzije: 20x22x60 mm
- masa: 50g
- pakiranje: 1
- šifra: **000032110**





Kensington

Zaštitni kabel za laptop Microsaver Lock

- za zaštitu laptopa od krađe
- kabel od čelika i karbona otporan na rezanje
- otključava se pomoću ključa
- šifra: **000029240**

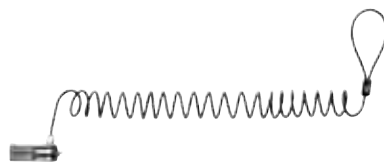

Kensington

Zaštitni kabel za laptop Portable Comb. lock

- za zaštitu laptopa od krađe
- kabel se može rastegnuti do 1,8 m
- četveroznamenkasti kod zaključavanja
- šifra: **000029241**



Genius

Bežična tipkovnica i miš SlimStar 8006

- ultra tanki dizajn
- omogućuje veliku udobnost prilikom korištenja
- šifra: **000032598**



Genius

- standardna tipkovnica crne boje
- USB priključak
- šifra: **000028153**



Genius

Tipkovnica KB-110X

- standardna tipkovnica crne boje
- USB priključak
- šifra: **000020109**



Genius

Tipkovnica KB-M200 USB

- s USB priključkom
- s 8 izdvojenih tipki za Internet i medije
- smanjuje buku prilikom korištenja
- šifra: **000020772**



Genius

Tipkovnica KB-06X PS/2

- s PS/2 priključkom
- šifra: **000012098**

Verbatim

Bežični laserski miš Go Nano

- s 3 tipke
- glatka površina za udobnost i kontrolu
- baterije: 2x AAA
- 2.4 GHz bežična tehnologija
- rezolucija: 1600dpi
- dimenzije: 95x58x35 mm
- dostupan u 4 boje

Šifra	Boja
000021491	roza
000021490	plava
000021489	narančasta
000021488	crna



Verbatim

Optički putni miš Go Mini

- iznimno lagan i prenosiv
- pogodan za ljevakе i dešnjake
- rezolucija: 1000dpi
- dimenzije: 150x42x29 mm
- dostupan u 4 boje

Šifra	Boja
000020308	roza
000020309	sv. plava
000020310	narančasta
000020307	crna



Kensington

Bežični miš Pro Fit

- ergonomski dizajn pruža udobnost
- dolazi s nano USB priključkom
- rezolucija: 1750 dpi
- 2.4 GHz bežični USB prijamnik plug 'n' play
- dostupan u 4 boje

Šifra	Boja
000025117	plava
000025118	crvena
000025119	siva
000025116	crna



**Optički miš Go Ergo**

- moderan ergonomski dizajn
- glatka gumirana površina za udobnost
- rezolucija: 1000dpi
- USB plug 'n' play
- dimenzije: 116x76x41 mm
- boja: crna
- šifra: **000020520**

**Optički miš Pro Fit**

- USB priključak
- ergonomski dizajn pruža udobnost
- rezolucija: 1000 dpi
- dimenzije: 91x50x137 mm
- boja: crna
- šifra: **000015464**

**Optički miš DX-110**

- USB priključak
- rezolucija: 1000 dpi
- boja: crna
- šifra: **000028154**

**Optički miš DX-110**

- PS/2 priključak
- rezolucija: 1000 dpi
- boja: crna
- šifra: **000030257**



PODLOGE ZA MIŠA

**Podloga za miša s pjеноm**

- jastučić na podlozi je smješten gdje se ruka prirodno oslanja, za neizmjerne udobnost
- punjenje jastučića je od pjene
- šifra: **000016053**

**Podloga za miša**

- klasična podloga
- pogodna i za dotisak

Šifra	Boja
000015461	plava
000015462	crvena
000015463	crna

**Podloga za miša s odmaračem zgloba Crystals Gel**

- udoban i elegantan
- udobna podrška za ublažavanje pritisak na zglobove
- izrađena od netoksičnog gela
- lako se čisti pomoću vlažne krpe
- neklizna baza prilagodljiva na bilo koju vrstu površina
- pakiranje: 4

Šifra	Boja	Dimenzija (mm)
000024828	plava	26x480x57
000024827	crna	26x480x57



Fellowes

Podloga za miša s odmaraćem zgloba I-Spire

- mekana i fleksibilna
- jednostavna za održavanje
- elegantan i jednostavan dizajn
- boja: siva
- dimenzija: 25x177x254 mm
- pakiranje: 4
- šifra: **000024831**

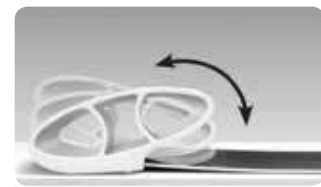

ODMARAČI ZGLOBA

Fellowes

Odmarač zgloba I-Spire

- cilindrični odmarać zgloba za tipkovnicu koja se pomiče tijekom uporabe
- mekana i fleksibilna
- jednostavna za održavanje
- elegantan i jednostavan dizajn
- boja: siva
- dimenzija: 25x334x68 mm
- pakiranje: 4
- šifra: **000024832**

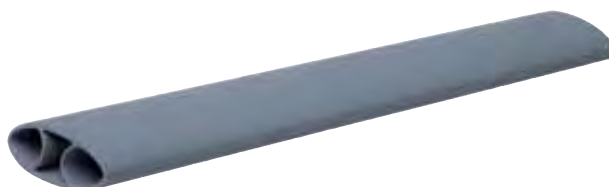

OSLOBODITE SE NAPETOSTI U ZGLOBU

Osjećam bol ili pritisak na svoj ručni zglob?

Tipkanje na tipkovnici ili laptopu na dugo vrijeme može uzrokovati bol i pritisak na ručni zglob. Kao i korištenje posebne tipkovnice za laptop, korištenje odmaraća za ručni zglob može poravnati zapešća, preraspodjelom pritiska sa osjetljivih točaka, ublažava bol i neugodu i sprječava potencijalne ozljede.

Fellowes

Odmarač zgloba Crystals Gel

- udoban i elegantan
- udobna podrška za ublažavanje pritiska na zglobove
- izrađen od netoksičnog gela
- lako se čisti pomoću vlažne krpe
- neklizna baza prilagodljiva na bilo koju vrstu površina
- boja: crna i plava
- dimenzija: 18x122x88 mm
- pakiranje: 4



Šifra	Boja
000024830	plava
000024829	crna





Kensington

Odmaráč za noge Solemate Comfort

- ergonomski dizajn
- poboljšava cirkulaciju i smanjuje umor
- kompaktan dizajn predviđen je i za male prostore
- podesiv po visini i nagibu
- dimenzija: 55x12x36 mm
- šifra: **000024987**



Kensington

Odmaráč za noge Solesaver

- PVC s neklizajućom gumom
- podesiv po visini i nagibu
- poboljšava držanje i oslobađa pritisak s leđa
- dimenzija: 45x35 mm
- šifra: **000023725**

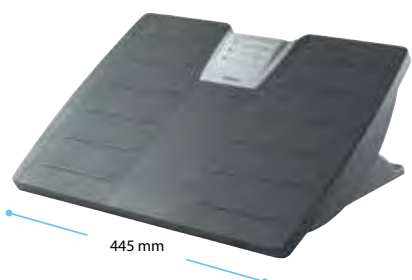

Fellowes

Odmaráč nogu Microban®

- sprječava nemir u nogama i osigurava ispravno držanje
- sadrži Microban® antibakterijsku zaštitu kako bi se spriječio rast bakterija
- položaj prilagođen pritiskom stopala i ostaje u željenom položaju dok je isti pritisak na površinu
- njihanje natrag i naprijed za poticanje cirkulacije u stopalima i nogama
- dimenzija: 111x445x334 mm
- pakiranje: 1
- šifra: **000025488**



Kensington

Odmaráč za noge - podloga za stajanje

- gumirana podloga s gel pjenu
- debljina gel pjene: 17 mm
- vodootporna i nekliziva
- poboljšava držanje i oslobađa pritisak s leđa
- dimenzija: 94x52x28 mm
- šifra: **000033021**



Fellowes**Odmarač leđa s mrežom**

- mreže s pojačanjima, odgovara obliku tijela
- sustav za pričvršćivanje Tri-tensioning™ eliminira potrebu za stalnim prilagodbama
- prilagođava se konturama tijela
- lako se prilagođava na stolici
- dimenzija: 535x460x220 mm
- pakiranje: 1
- šifra: **000025486**

**OFFICE SUITES™****Fellowes****Odmarač leđa s mrežom**

- mrežasti odmarać leđa s jastučićima
- sustav za pričvršćivanje Tri-tensioning™ eliminira potrebu za stalnim prilagodbama
- prilagođava se konturama tijela
- potpora za lumbalni dio leđa podesiva po visini
- lako se prilagođava na stolici
- dimenzija: 536x460x220 mm
- pakiranje: 1
- šifra: **000027024**

**OFFICE SUITES™****Kensington****Odmarač leđa Memory Foam**

- smanjuje naprezanje leđa dok radite na stolu, te pruža udobnost i poboljšava držanje
- visoka gustoća memorijske pjene pruža maksimalnu potporu za ublažavanje nelagode
- za razliku od gelova i pjena, memorijska pjena ne sadrži praktički nikakve pritisne točke
- jednostavno se prilagođava na gotovo svakoj stolici
- dimenzija: 320x350x40 mm
- pakiranje: 1
- šifra: **000033020**



OFFICE SUITES™



Fellowes

Držak dokumenata sa memo pločom

- 3 u 1: stalak, ploča i držač papira
- podešivi nagib od 45°
- klizno ravnalo koje se može ukloniti
- kvačica drži do 150 listova A4
- dimenzija: 381x260x153 mm
- pakiranje: 1
- šifra: **000025492**



Fellowes

Postolje za monitor

- podesite monitor na odgovarajuću visinu i spriječite ukočenost vrata
- podesivo u dvije visine: 10 i 15 cm
- pogodno za velike monitore do 36 kg
- prostor ispod omogućuje vam da pohranite svoje prijenosno računalo i sačuvate prostor
- uključuje pretinac za rukavice i skladištenje
- dimenzija: 106x505x357 mm
- pakiranje: 1
- šifra: **000025493**

OFFICE SUITES™

OFFICE SUITES™



Fellowes

Postolje za laptop

- podiže ekran laptopa na optimalan kut gledanja
- podešava do 5 pozicija 11-16,5 cm
- prednji stoper drži laptop na mjestu
- za prijenosna računala do 5 kg težine i do 15"
- dimenzija: 165x384x289 mm
- pakiranje: 1
- šifra: **000025494**



OSLOBODITE SE NAPETOSTI U VRATU

Želite li smanjiti napetost u vratu?

Naginjanje prema naprijed i naginjanje glave da vidite monitor računala može prouzročiti naprezanje u leđima i vratu. Koristite postolje za laptop ili monitor kako bi osigurali položaj zaslona na istoj razini očiju. Ovi proizvodi će smanjiti napetost u ramenima, vratu i očima postavljanjem monitora ili laptopa na visinu i adekvatan nagib.

SREDSTVA ZA ČIŠĆENJE



Sredstvo za čišćenje u spreju Soffio

- sredstvo za čišćenje nedostupnih dijelova računala, tastatura, printera, optičkih uređaja i druge elektronske opreme
- sadrži komprimirani zrak koji skida naslage prašine i ne oštećuje mehanizme
- široka mogućnost upotrebe
- ne sadrži tvari koje oštećuju ozon
- količina: 400 ml
- pakiranje: 12
- šifra: **000006269**



Sredstvo za čišćenje u spreju Nuvola

- sredstvo za čišćenje plastičnih površina, poput kućišta printera, računala, monitora...
- antistatičko djelovanje
- ne sadrži tvari koje oštećuju ozon
- količina: 400 ml
- pakiranje: 12
- šifra: **000005738**



fornax**Komplet sredstava za čišćenje**

- set sadrži:
 - sprej za čišćenje plastike 250 ml,
 - komprimirani zrak 400 ml,
 - sprej za čišćenje ekrana 250 ml,
 - 10 suhih maramica
- pakiranje: 1
- šifra: **000018669**

**fornax****Sredstvo za čišćenje komprimirani zrak**

- čisti prljavštinu, prašinu i naslage s teško dostupnih mjesta
- idealno za upotrebu na elektroničkoj i ostaloj opremi
- količina: 400 ml
- pakiranje: 1
- šifra: **000018663**

**fornax****Maramice za čišćenje plastike**

- vlažne maramice
- učinkovito čiste plastiku, metal i plastificirane površine
- ne preporučuju se za staklo
- antistatičko djelovanje
- set od 100 maramica
- pakiranje: 1
- šifra: **000018593**

**fornax****Maramice za čišćenje ekrana**

- vlažne maramice bez alkohola
- koriste se za čišćenje LCD i standardnih ekrana
- sprječavaju statički efekt
- set od 100 maramica
- pakiranje: 1
- šifra: **000018592**

**fornax****Sredstvo za čišćenje ekrana u spreju**

- bezalkoholna formula
- efikasno čisti staklene površine i monitore
- antistatičko djelovanje
- količina: 250 ml
- pakiranje: 1
- šifra: **000018590**

**fornax****Sredstvo za čišćenje plastike u spreju**

- prirodna eterična ulja pomiješana s kemijskim elementima
- za čišćenje plastične površine računala i uredske opreme
- antistatičko djelovanje
- količina: 250 ml
- pakiranje: 1
- šifra: **000018591**

**fornax****Sprej za ploče**

- bezalkoholna formula
- za temeljito čišćenje bijelih ploča od tinte, prljavštine i ostalih mrlja
- ne ostavlja tragove
- količina: 250 ml
- pakiranje: 1
- šifra: **000022165**

**Sprej za ploče Data Flash**

- za brisanje bijelih ploča
- količina: 250 ml
- pakiranje: 12
- šifra: **000012134**



DESIGN. ECO. BUSINESS
Reliable Calculators

CITIZEN



U svakom uredu kao kod kuće

Citizen kalkulatori su dizajnirani da zadovolje Vaše i potrebe Vaših kupaca.

Citizen - Brend kojeg biramo!
Široki asortiman džepnih, stolnih i kalkulatora s trakom koji pružaju pouzdanost i visoke performanse.







OBJAŠNJENJE IKONA

reže na
trakereže na
konfetemikro
usitnjavanjesuper
mikro
usitnjavanjeP-2
stupanj
sigurnostiuništava
zaklamane
dokumenteuništava
spajaliceuništava
kreditne
karticeuništava
CD-oveZa svakodnevnu
papirologiju koja ne sadrži
osjetljive informacijeReže 1 A4 list u
40 komadaZa svakodnevnu
papirologiju koja sadrži
osjetljive informacijeReže 1 A4 list u
približno 200 komadaZa poslovne dokumente
koji sadrže informacije o
vlasništvu i/ili osjetljive
osobne informacijeReže 1 A4 list u
približno 400 komadaZa povjerljive poslovne
dokumente s ID,
financijskom i strateškom
informacijomReže 1 A4 list u
približno 2000 komadaZa jako osjetljive
financijske, pravne i
vojne informacijeReže 1 A4 list u
približno 6000 komada

Rexel



Za vrijeme uništavanja papira, posebni mehanizmi sa senzorom kontinuirano prepoznaju ulaz novog papira, te ga uništavaju bez zaglavlivanja.



Uništivač svjetlosnim signalom upozorava kada je previše papira umetnuto, te neće početi uništavati papir dok ga je previše.



Uništivač je dizajniran tako da jako tiho obavlja uništavanje, te je idealan za okolinu.



Uništivač prihvaća veliki volumen papira.



Reciklirajuća papirna vrećica je dostupna za ovakve uništivače, a služi za jednostavniji način pražnjenja uništenog papira.



Uništivač se automatski ugasi nakon kratkog vremena, radi uštede energije i snage.



Rezalice unutar uništivača se samostalno čiste, otklanjajući komadiće papira.



Uništivač se može koristiti konstantno, bez hlađenja, bez izgubljenog vremena.



Tipka koja služi za povećanje snage čišćenja aparata.



Uništeni papir se raspoređuje u kanti, te omogućuje više uništavanja i manje pražnjenja.



Uništivač automatski slaže komadiće papira.



Izrazito veliki kapacitet kante, radi rijedeg pražnjenja.



Vraća papir ako ga je previše.



Jednostavno i brzo pražnjenje kante, bez pomicanja glave uništivača.



Glava uništivača je namještena tako da se jednostavno i sigurno može umetnuti papir.



Automatsko podmazivanje glave rezača omogućuje automatsko podmazivanje kada je to potrebno.



Fellowes



Sprečava zaustavljanje uništavanja i sprečava zaglave.



Isključuje uređaj nakon 2 minute neaktivnosti.



Idelano za velike volumene uništavanja. Uređaj je uvijek spreman za rad.



Ultra tiho uništavanje pogodno za dijeljena radna okruženja.



Zaustavlja uništavanje kad ruke dotaknu ulaz za papir.



Sprečava slučajnu aktivaciju.



Automatski zaključava ladicu za papir dok traje uništavanje kako bi se spriječio pristup otpadu dok nije uništen.



Eliminira zaglave i provlači više papira od predviđenog.



Smanjuje potrošnju energije i isključuje uređaj nakon perioda neaktivnosti.



Rexel

Uništivač Momentum X308

- reže na konfete 5x42 mm
- uništava 8 listova (80g/m²) u prolazu
- kapacitet kante: 15l
- dimenzija: 325x343x229 mm
- šifra: **000033090**



Rexel

Uništivač Momentum X406

- reže na konfete 4x30 mm
- uništava 6 listova (80g/m²) u prolazu
- kapacitet kante: 15l
- dimenzija: 325x343x229 mm
- šifra: **000033091**



Rexel

Uništivač Momentum X312-SL

- reže na konfete 5x42 mm
- uništava 12 listova (80g/m²) u prolazu
- kapacitet kante: 23l
- dimenzija: 255x375x370 mm
- šifra: **000033099**



Rexel

Uništivač Momentum X410

- reže na konfete 4x30 mm
- uništava 10 listova (80g/m²) u prolazu
- kapacitet kante: 23l
- dimenzija: 356x423x238 mm
- šifra: **000033100**



Rexel

Uništivač Momentum X415

- reže na konfete 4x40 mm
- uništava 15 listova (80g/m²) u prolazu
- kapacitet kante: 23l
- dimenzija: 370x465x279 mm
- šifra: **000033101**



Rexel

Uništivač Momentum M515

- reže na konfete 2x15 mm
- uništava 15 listova (80g/m²) u prolazu
- kapacitet kante: 30l
- dimenzija: 406x542x320 mm
- šifra: **000033102**





Kvaliteta na najvišem nivou



Rexel Momentum Veća snaga za dulji neprekidan rad

Ako trebate uništivač na kojeg se možete osloniti, Rexel Momentum je upravo takav! Neprekidni rad do 4 sata, micro cut uništavanje za veću sigurnost i jednostavno upravljanje, čine Rexel Momentum da ima snagu uvijek Vam pružiti više!

www.rexeurope.com

Rexel[®]
THE **CLEVER** CHOICE



Rexel

Uništivač Alpha Ribbon cut

- reže na trake širine 7.2 mm
- uništava 5 listova (80g/m²) u prolazu
- kapacitet kante: 10l
- dimenzija: 300x290x150 mm
- šifra: **000012054**



Fellowes

Uništivač P-25S

- reže na trake 7 mm
- uništava 5 listova (70g/m²) u prolazu
- kapacitet kante: 11l
- dimenzija: 300x302x160 mm
- šifra: **000028788**



Rexel

Uništivač Style+

- reže na konfete 4x24 mm
- uništava 7 listova (80g/m²) u prolazu
- kapacitet kante: 12l
- dimenzija: 370x200x380 mm
- šifra: **000012055**



Rexel

Uništivač RPS812

- reže na trake širine 6 mm
- uništava 8 listova (80g/m²) u prolazu
- kapacitet kante: 12l
- dimenzija: 381x331x208 mm
- šifra: **000030674**



Rexel

Uništivač Promax RPX612

- reže na konfete širine 4x45 mm
- uništava 6 listova (80g/m²) u prolazu
- kapacitet kante: 12l
- dimenzija: 381x331x208 mm
- šifra: **000030670**



Fellowes

Uništivač 36C

- reže na konfete 4x40 mm
- uništava 6 listova (70g/m²) u prolazu
- kapacitet kante: 12l
- dimenzija: 330x212x381 mm
- šifra: **000032048**



**Fellowes****Uništivač M-7C**

- reže na konfete 4x46 mm
- uništava 7 listova (70g/m²) u prolazu
- kapacitet kante: 14l
- dimenzija: 320x186x387 mm
- šifra: **000032049**

**ReXel****Uništivač Alpha Confetti cut**

- reže na konfete 4x38 mm
- uništava 5 listova (80g/m²) u prolazu
- kapacitet kante: 14l
- dimenzija: 370x325x170 mm
- šifra: **000016694**

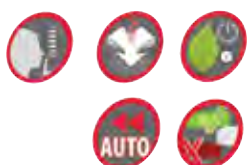
**ReXel****Uništivač New Auto+ 60X**

- reže na konfete 4x45 mm
- uništava 60 listova (80g/m²) u jednom prolazu, odnosno 5 listova ako ulažemo listove rukom
- kapacitet kante: 15l
- dimenzija: 288x418x361 mm
- šifra: **000020877**

**Fellowes****Uništivač P-28S**

- reže na trake 6 mm
- uništava 8 listova (70g/m²) u prolazu
- kapacitet kante: 15l
- dimenzija: 38x320x189 mm
- šifra: **000028789**

**ReXel****Uništivač Duo**

- reže na konfete 4x45 mm
- uništava 10 listova (80g/m²) u prolazu
- kapacitet kante: 17l
- dimenzija: 400x365x257 mm
- šifra: **000023188**

**ReXel****Uništivač Prostyle**

- reže na konfete 4x35 mm
- uništava 11 listova (80g/m²) u prolazu
- kapacitet kante: 20l
- dimenzija: 410x220x440 mm
- šifra: **000012056**





ReXel

Uništivač Prostyle+

- reže na konfete 4x35 mm
- uništava 13 listova (80g/m²) u prolazu
- kapacitet kante: 20l
- dimenzija: 276x470x488 mm
- šifra: **000020881**

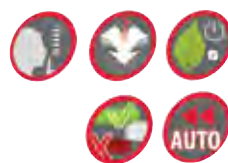

ReXel

Uništivač New Auto+ 80X

- reže na konfete 4x45 mm
- uništava 80 listova (80g/m²) u jednom prolazu, odnosno 6 listova ako ulažemo listove rukom
- kapacitet kante: 20l
- dimenzija: 395x295x430 mm
- šifra: **000020878**



ReXel

Uništivač REM820

- reže na konfete 2x15 mm
- uništava 8 listova (70g/m²) u prolazu
- kapacitet kante: 21l
- dimenzija: 540x389x275 mm
- šifra: **000024931**



Fellowes

Uništivač P-60CS

- reže na konfete 4x40 mm
- uništava 10 listova (70g/m²) u prolazu
- brzina uništavanja (mpm): 4
- kapacitet kante: 22l
- dimenzija: 410x235x370 mm
- šifra: **000025478**



Fellowes

Uništivač 450M

- reže na konfete 2x12 mm
- uništava 9 listova (70g/m²) u prolazu
- brzina uništavanja (mpm): 2.1
- kapacitet kante: 22l
- dimenzija: 565x351x261 mm
- šifra: **000033074**



**Fellowes****Uništivač 53C**

- reže na konfete 4x35 mm
- uništava 10 listova (70g/m²) u prolazu
- kapacitet kante: 23l
- dimenzija: 387x320x185 mm
- šifra: **000021643**

**Rexel****Uništivač RES823**

- reže na trake širine 6 mm
- uništava 8 listova (80g/m²) u prolazu
- kapacitet kante: 23l
- dimenzija: 415x349x263 mm
- šifra: **000030673**

**Rexel****Uništivač RES1123**

- reže na trake širine 6 mm
- uništava 12 listova (80g/m²) u prolazu
- kapacitet kante: 23l
- dimenzija: 415x349x263 mm
- šifra: **000030672**

**Rexel****Uništivač Promax REX623**

- reže na konfete širine 4x40 mm
- uništava 6 listova (80g/m²) u prolazu
- kapacitet kante: 23l
- dimenzija: 415x349x263 mm
- šifra: **000030669**

**Rexel****Uništivač Promax REX823**

- reže na konfete širine 4x40 mm
- uništava 8 listova (80g/m²) u prolazu
- kapacitet kante: 23l
- dimenzija: 466x345x230 mm
- šifra: **000031030**

**Rexel****Uništivač RES1323**

- reže na konfete 4x40 mm
- uništava 13 listova (80g/m²) u prolazu
- kapacitet kante: 23l
- dimenzija: 413x269x471 mm
- šifra: **000027718**



**Rexel****Uništivač Auto+ 130X**

- reže na konfete 4x40 mm
- uništava 130 listova (80g/m²) u jednom prolazu, odnosno 6 listova ako ulažemo listove rukom
- kapacitet kante: 26l
- dimenzija: 430x312x448 mm
- šifra: **000031216**

**Rexel****Uništivač Mercury RSM1130**

- reže na konfete 1.9x15 mm
- uništava 11 listova (80g/m²) u prolazu
- kapacitet kante: 30l
- dimenzija: 570x420x320 mm
- šifra: **000016701**

**Fellowes****Uništivač 46Ms**

- reže na konfete 2x14 mm
- uništava 12 listova (70g/m²) u prolazu
- brzina uništavanja (mpm): 1.8
- kapacitet kante: 30l
- dimenzija: 650x368x290 mm
- šifra: **000033073**

**Rexel****Uništivač Mercury RSS2232**

- reže na trake širine 5.8mm
- uništava 22 lista (80g/m²) u prolazu
- kapacitet kante: 32l
- dimenzija: 584x270x535 mm
- šifra: **000016702**

**Rexel****Uništivač RES1834**

- reže na konfete 4x40 mm
- uništava 19 listova (80g/m²) u prolazu
- kapacitet kante: 34l
- dimenzija: 610x398x320 mm
- šifra: **000027717**





Fellowes

Uništivač 99Ci

- reže na konfete 4x38 mm
- uništava 17 listova (70g/m²) u prolazu
- kapacitet kante: 34l
- dimenzija: 592x288x442 mm
- šifra: **000024808**



Rexel

Uništivač RSS1535

- reže na trake širine 6 mm
- uništava 15 listova (80g/m²) u prolazu
- kapacitet kante: 35l
- dimenzija: 472x397x283 mm
- šifra: **000030671**



Rexel

Uništivač Promax RSX1035

- reže na konfete širine 4x40 mm
- uništava 10 listova (80g/m²) u prolazu
- kapacitet kante: 35l
- dimenzija: 427x397x283 mm
- šifra: **000030668**



Rexel

Uništivač Promax RSS1838

- reže na trake širine 6 mm
- uništava 18 listova (80g/m²) u prolazu
- kapacitet kante: 38l
- dimenzija: 630x410x310 mm
- šifra: **000030478**



Rexel

Uništivač RSX1538

- reže na konfete 4x40 mm
- uništava 15 listova (80g/m²) u prolazu
- kapacitet kante: 38l
- dimenzija: 630x410x310 mm
- šifra: **000031029**

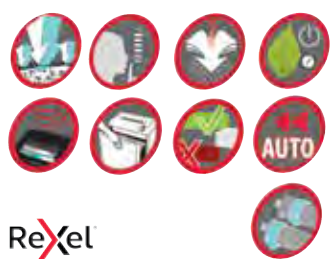

Rexel

Uništivač New Auto+ 300X

- reže na konfete 4x40mm
- uništava 250 listova (80g/m²) u jednom prolazu, odnosno 8 listova ako ulažemo listove rukom
- kapacitet kante: 40l
- dimenzija: 590x350x490 mm
- šifra: **000020879**



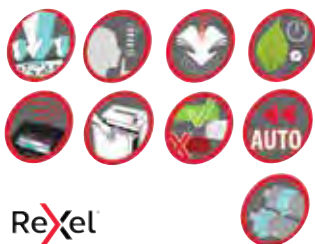

ReXel

Uništivač New Auto+ 300M

- reže na konfete 2x15mm
- uništava 230 listova (80g/m²) u jednom prolazu, odnosno 9 listova ako ulažemo listove rukom
- kapacitet kante: 40l
- dimenzija: 650x350x490 mm
- šifra: **000024839**



ReXel

Uništivač Mercury RDS2250

- reže na trake širine 5.8 mm
- uništava 22 lista (80g/m²) u prolazu
- kapacitet kante: 50l
- dimenzija: 676x480x370 mm
- šifra: **000014695**



ReXel

Uništivač Mercury RDX1850

- reže na konfete 4x45 mm
- uništava 18 listova (80g/m²) u prolazu
- kapacitet kante: 50l
- dimenzija: 676x480x370 mm
- šifra: **000016704**



ReXel

Uništivač Mercury RDM1150

- reže na konfete 1.9x15 mm
- uništava 12 listova (80g/m²) u prolazu
- kapacitet kante: 50l
- dimenzija: 676x480x370 mm
- šifra: **000016705**



ReXel

Uništivač Mercury RDSM750

- reže na konfete 0.8x11 mm
- uništava 7 listova (80g/m²) u prolazu
- kapacitet kante: 50l
- dimenzija: 676x480x370 mm
- šifra: **000016706**





Fellowes

Uništivač 125Ci

- reže na konfete 4x38 mm
- uništava 18 listova (70g/m²) u prolazu
- kapacitet kante: 53l
- dimenzija: 735x283x530 mm
- šifra: **000024806**



Fellowes

Uništivač 225Ci

- reže na konfete 4x38 mm
- uništava 20 listova (70g/m²) u prolazu
- kapacitet kante: 60l
- dimenzija: 785x454x435 mm
- šifra: **000025364**



Fellowes

Uništivač 225Mi

- reže na konfete 2x12 mm
- uništava 14 listova (70g/m²) u prolazu
- kapacitet kante: 60l
- dimenzija: 785x454x435 mm
- šifra: **000025363**



Rexel

Uništivač Mercury RDS2270

- reže na trake 5.8 mm
- uništava 22 lista (80g/m²) u prolazu
- kapacitet kante: 70l
- dimenzija: 676x480x370 mm
- šifra: **000016707**



Rexel

Uništivač Mercury RDX2070

- reže na konfete 4x45mm
- uništava 20 listova (80g/m²) u prolazu
- kapacitet kante: 70l
- dimenzija: 676x480x370 mm
- šifra: **000016708**



Fellowes**Uništivač Automax 550c**

- reže na konfete 4x38 mm
- uništava 550 listova (70g/m²) u jednom prolazu, odnosno 14 listova ako ulažemo listove rukom
- brzina uništavanja (mpm): 3.35
- kapacitet kante: 83l
- dimenzija: 891x441x578 mm
- šifra: **000032243**

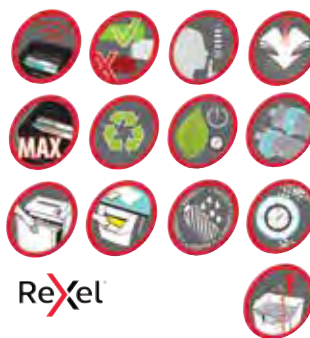
**ReXel****Uništivač RLS32**

- reže na trake 5.8 mm
- uništava 32 lista (80g/m²) u prolazu
- kapacitet kante: 115l
- dimenzija: 890x540x540 mm
- šifra: **000016709**

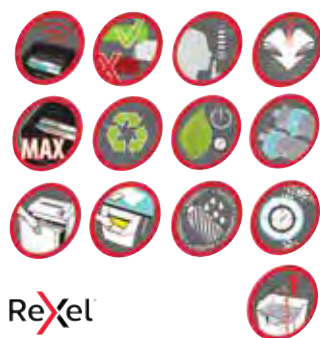
**ReXel****Uništivač RLX20**

- reže na konfete 4x40 mm
- uništava 20 listova (80g/m²) u prolazu
- kapacitet kante: 115l
- dimenzija: 890x540x540 mm
- šifra: **000016710**

**ReXel****Uništivač AUTO+ 750X**

- reže na konfete 4x40 mm
- uništava 750 listova (80g/m²) u jednom prolazu, odnosno 12 listova ako ulažemo listove rukom
- kapacitet kante: 115l
- dimenzija: 940x520x510 mm
- šifra: **000021689**

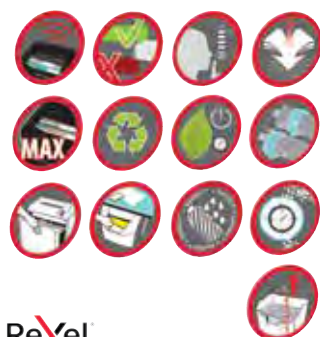
**ReXel****Uništivač RLM11**

- reže na konfete 1.9x15 mm
- uništava 11 listova (80g/m²) u prolazu
- kapacitet kante: 115l
- dimenzija: 890x540x540 mm
- šifra: **000016711**





OBJAŠNJENJE NAPAJANJA



- baterija



- baterija



- solarno



- baterija i solarno



- adapter na struju



CITIZEN

**Kalkulator SDC-444S**

- zaslon s 12 znamenki
- kvadratni korijen
- dimenzije: 153x199x30.5 mm
- pakiranje: 1
- šifra: **000013494**



CITIZEN

**Kalkulator SDC-4310**

- zaslon s 12 znamenki
- funkcija označavanja
- funkcija dvostrukog opozivanja
- kvadratni korijen
- memorija
- signaliziranje promjene +/-
- ima tipku TAB
- dimenzija: 174.5x130x33 mm
- pakiranje: 1
- šifra: **000017372**



CITIZEN

**Kalkulator SDC-554S**

- zaslon s 14 znamenki
- sa standardnim i kutnim LCD zaslonom
- funkcija označavanja
- obračunava porez
- memorija
- funkcija zaokruživanja
- dimenzija: 199x153x30.5 mm
- pakiranje: 1
- šifra: **000017373**



CITIZEN

**Kalkulator SDC-805II**

- zaslon s 8 znamenki
- sa standardnim i kutnim LCD zaslonom
- memorija
- dimenzija: 131x102x18 mm
- pakiranje: 1
- šifra: **000017374**



CITIZEN

**Kalkulator SDC-810BN**

- zaslon s 10 znamenki
- dimenzije: 100x125x34 mm
- pakiranje: 1
- šifra: **000013495**



CITIZEN

**Kalkulator SDC-812BN**

- zaslon s 12 znamenki
- dimenzije: 100x125x34 mm
- pakiranje: 1
- šifra: **000013496**



CITIZEN

**Kalkulator CDB1601-BK**

- zaslon s 16 znamenki
- kvadratni korijen
- funkcija označavanja
- memorija
- dimenzije: 200x157x35 mm
- pakiranje: 1
- šifra: **000032364**



CITIZEN

**Kalkulator CDB1401-BK**

- zaslon s 14 znamenki
- kvadratni korijen
- funkcija označavanja
- memorija
- dimenzije: 200x157x35 mm
- pakiranje: 1
- šifra: **000032363**



CITIZEN

**Kalkulator CDB1201-BK**

- zaslon s 12 znamenki
- kvadratni korijen
- funkcija označavanja
- memorija
- dimenzije: 200x157x35 mm
- pakiranje: 1
- šifra: **000032362**



CITIZEN

**Kalkulator CMB1201-BK**

- zaslon s 12 znamenki
- kvadratni korijen
- memorija
- dimenzije: 137x102x31 mm
- pakiranje: 1
- šifra: **000032361**



CITIZEN

**Kalkulator CMB1001-BK**

- zaslon s 10 znamenki
- kvadratni korijen
- memorija
- dimenzije: 137x102x31 mm
- pakiranje: 1
- šifra: **000032360**



CITIZEN

**Kalkulator CMB801-BK**

- zaslon s 8 znamenki
- kvadratni korijen
- memorija
- dimenzije: 137x102x31 mm
- pakiranje: 1
- šifra: **000032359**



CITIZEN

**Kalkulator SLD-366**

- zaslon s 10 znamenki
- memorija
- funkcija zaokruživanja
- dimenzija: 104x65.5x10 mm
- pakiranje: 1
- šifra: **000017377**



CITIZEN

**Kalkulator LC-310N**

- zaslon s 8 znamenki
- kvadratni korijen
- dimenzije: 69x113x23 mm
- pakiranje: 1
- šifra: **000013497**



CITIZEN

**Kalkulator SR-270X**

- zaslon s 10+2 znamenke
- dvo-linijski display
- 251 funkcija
- trigonometrijske funkcije
- 7 nezavisnih memorijskih funkcija
- 24 mogućnosti sa zagradama
- hiperbolne funkcije
- pojednostavljenje frakcije funkcije
- pretvaranje decimalnih zapisa
- pretvaranje jedinica za kut
- dimenzija: 164.5x84.3x21.2 mm
- pakiranje: 1
- šifra: **000020398**



CITIZEN

**Kalkulator SR-270 II**

- zaslon s 10 + 2 znamenke
- 236 funkcija
- dimenzije: 75x148 x12.5 mm
- pakiranje: 1
- šifra: **000013499**





CITIZEN

Kalkulator CDC-80 Allrounder

- zaslon s 10 znamenki
- obračunava porez
- kvadratni korijen
- dimenzije: 108.5x135x24.5 mm
- pakiranje: 1

- 000016161
- 000013493
- 000016158
- 000016160



CITIZEN

Kalkulator CDC-100 Allrounder

- zaslon s 10 znamenki
- obračunava porez
- kvadratni korijen
- dimenzije: 108.5x135x24.5 mm
- pakiranje: 1
- šifra: 000013491



CITIZEN

Kalkulator CDC-112 Cosmopolitan

- zaslon s 12 znamenki
- obračunava porez
- pretvaranje valute
- dimenzije: 130x174.5x33 mm
- pakiranje: 1
- šifra: 000013492

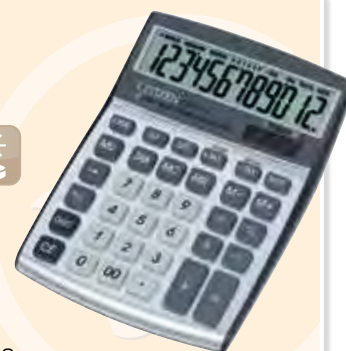

CITIZEN

Kalkulator CPC-110 Basic

- zaslon s 10 znamenki
- pretvaranje valute
- dimenzije: 64x105x10 mm
- pakiranje: 1
- šifra: 000013488



CITIZEN

Kalkulator CPC-112 Basic+

- zaslon s 12 znamenki
- pretvaranje valute
- obračunava porez
- dimenzije: 79x120x9 mm
- pakiranje: 1
- šifra: 000013489



CITIZEN

Kalkulator CPC-210

- display u dva reda
- obračunava porez
- sadrži marginu troškova prodaje
- pretvaranje valute
- dimenzija: 136x79x12 mm
- pakiranje: 1
- šifra: 000017363



CITIZEN

Kalkulator CPC-1010

- zaslon s 10 znamenki
- sadrži marginu troškova prodaje
- pretvaranje valute
- obračunava porez
- dimenzija: 79x136x12 mm
- pakiranje: 1
- šifra: 000017362





CITIZEN

Kalkulator CTC-110

- zaslon s 10 znamenki
- obračunava porez
- pretvaranje valute
- funkcija označavanja
- dimenzija: 106x63x14 mm
- pakiranje: 1
- šifra: **000017364**



CITIZEN

Kalkulator ECC-110

- zaslon s 8 znamenki
- punjenje na solarnu energiju
- napravljen od 70% reciklirane plastike
- pakiranje i instrukcije napravljene od recikliranog materijala
- memorija
- dimenzije: 120x72x15 mm
- pakiranje: 1
- šifra: **000020860**



CITIZEN

Kalkulator ECC-210

- zaslon s 8 znamenki
- punjenje na solarnu energiju
- napravljen od 70% reciklirane plastike
- pakiranje i instrukcije napravljene od recikliranog materijala
- memorija
- dimenzije: 143x102x29 mm
- pakiranje: 1
- šifra: **000020861**



CITIZEN

Kalkulator ECC-310

- pomični zaslon s 12 znamenki
- punjenje na solarnu energiju
- napravljen od 70% reciklirane plastike
- pakiranje i instrukcije napravljene od recikliranog materijala
- memorija
- s tipkom za pomicanje decimala
- dimenzije: 184x133x34 mm
- pakiranje: 1
- šifra: **000020862**



Linija Citizen-ovih Eco kalkulatora



- Blue Angel Eco certifikat
- samo solarno punjenje
- kalkulatori napravljeni od reciklirane plastike
- pakiranje napravljeno od recikliranog materijala



CITIZEN

Kalkulator SR-260

- 165 integriranih funkcija
- trigonometrijske funkcije
- kombinacije i permutacije
- kompleksni brojevi
- sredina, standardna devijacija
- zadržavanje memorije
- dimenzija: 154x80x14 mm
- pakiranje: 1



- **000017382**
- **000017475**



CITIZEN

**Kalkulator SR-135T II**

- zaslon s 8 + 2 znamenke
- 128 funkcija
- dimenzije: 78x141x12 mm
- pakiranje: 1
- šifra: **000013498**



CITIZEN

**Kalkulator LC-110N**

- zaslon s 8 znamenki
- memorija
- kvadratni korijen
- dimenzije: 87x58x12 mm
- pakiranje: 1

- **000018644**
- **000018643**
- **000015263**
- **000018645**



BATERIJE ALKALNE

Verbatim**AAA alkalne baterije**

- preporučuje se njihova uporaba u uređajima kao što su MP3 uređaji za reprodukciju, kamere i igračke koje zahtijevaju stalnu veliku snagu kroz dulje vrijeme
- napon: 1.5V
- visina: 44.5mm
- promjer: 10.5mm
- težina: 11g
- pakiranje: 4/1
- šifra: **000012776**

**Verbatim****AAA alkalne baterije**

- preporučuje se njihova uporaba u uređajima kao što su MP3 uređaji za reprodukciju, kamere i igračke
- napon: 1.5V
- visina: 44.5 mm
- promjer: 10.5 mm
- težina: 11 g
- pakiranje: 10/1
- šifra: **000032061**

**Verbatim****AA alkalne baterije**

- preporučuje se njihova uporaba u uređajima kao što su prijenosni radio uređaji, MP3 uređaji za reprodukciju, kamere i TV/DVD daljinski upravljači
- napon: 1.5V
- visina: 50.5mm
- promjer: 14.5mm
- težina: 23g
- pakiranje: 4/1
- šifra: **000012777**

**Verbatim****AA alkalne baterije**

- preporučuje se njihova uporaba u uređajima kao što su prijenosni radio uređaji, MP3 uređaji za reprodukciju, kamere i TV/DVD daljinski upravljači
- napon: 1.5V
- visina: 50.5 mm
- promjer: 14.5 mm
- težina: 23 g
- pakiranje: 10/1
- šifra: **000032062**





SIGURNOST PRI RUKOVANJU S BATERIJAMA

1. Baterije su u kratkom spoju ako pozitivan i negativan pol dođu u dodir jedan s drugim. To može dovesti do pražnjenja ili curenja.
2. Sve baterije držite podalje od pristupa djece. Ako dođe do gutanja baterije odmah potražite medicinsku pomoć.
3. Ne punite baterije. Punjenje baterija koje nisu predviđene za punjenje uzrokuje stvaranje plinova i/ili topline što može dovesti do eksplozije i/ili vatre.
4. Ne bacajte baterije u vatru.
5. Ne spajajte iste polove baterija zajedno.
6. Nemojte deformirati, gnječiti ili bušiti baterije.
7. Nemojte rezati baterije.
8. Nemojte bacati baterije s ostalim kućnim otpadom.



Verbatim

C alkalne baterije

- su idealno rješenje za bljeskalice i baklje
- baterije C se preporučuju za uporabu u uređajima kao što su bljeskalice, baklje i radio uređaji
- napon: 1.5V
- visina: 50mm
- promjer: 26.2mm
- težina: 61g
- pakiranje: 2
- šifra: **000012775**



Verbatim

D alkalne baterije

- kao i Verbatimove baterije modela C, model D je idealan za uporabu u bakljama i bljeskalicama
- ujedno se preporučuju za uporabu u velikim stereo kutijama kojima daju dugotrajne performanse
- napon: 1.5V
- visina: 61.5mm
- promjer: 34.2mm
- težina: 134g
- pakiranje: 2
- šifra: **000012779**



Verbatim

Verbatimove baterije pružaju siguran izvor snage za sve primjene kada se koriste na ispravan način. Ne smiju se nepravilno koristiti ili zlorabiti, a ove pojedinosti treba imati na umu u svakom trenutku.

Verbatim

9V alkalne baterije

- za Verbatimove 9V baterije se preporučuje uporaba kod kućnih dimnih alarmnih sustava jer daju visoku performansu
- ujedno se Verbatimove 9V baterije preporučuju za uporabu u dječjim igračkama
- napon: 9V
- visina: 48.5mm
- težina: 46g
- pakiranje: 1
- šifra: **000012778**



Verbatim**AAA vrhunske punjive baterije**

- mogu se koristiti u digitalnim foto-aparatima, daljinskim upravljačima, MP3 čitačima i drugim uređajima
- traju do 5 puta dulje od alkalnih baterija u digitalnim foto-aparatima
- punjive baterije ne štete okolišu
- svaka NiMH baterija je jednaka 500-1000 alkalnih baterija
- kemija baterije: NiMH
- napon: 1,2V
- kapacitet: 1000mAh serije
- pakiranje: 4/1
- šifra: **000014440**

**Verbatim****AA vrhunske punjive baterije**

- mogu se koristiti u digitalnim foto-aparatima, daljinskim upravljačima, MP3 čitačima i drugim uređajima
- traju do 5 puta dulje od alkalnih baterija u digitalnim foto-aparatima
- punjive baterije ne štete okolišu
- svaka NiMH baterija je jednaka 500-1000 alkalnih baterija
- kemija baterije: NiMH
- napon: 1,2V
- kapacitet: 2500mAh serije
- pakiranje: 4/1
- šifra: **000014441**

**Verbatim****Kompaktni punjač - EU utikač**

- napravljen za napajanje NiMH baterija i AA i AAA veličine
- sa svakom punjivom baterijom ekvivalentnom 500-1000 alkalnih baterija, ovaj ekološki prihvatljiv punjač je velika ušteda u troškovima
- zeleni LED pokazivači će ostati uključeni tijekom punjenja, a isključit će se tek kad je punjač isključen ili su baterije uklonjene
- jednostavno uključite direktno na izvor napajanja i umetnite baterije
- možete potpuno napuniti baterije već za 7 sati
- za nove baterije, potrebno je 2 do 3 puta punjenja i ciklusa uporabe da bi se optimizirale performanse baterija
- šifra: **000014048**



TELEFONI

**Panasonic****Bežični telefon KX-PRW110FXW**

- prikaz broja pozivatelja (Caller ID)
- TFT zaslon u boji od 2,2 inch
- frekvencija: 1,9 GHz
- mogućnost umrežavanja do 6 slušalica i mogućnost umrežavanja do 4 baze
- kapacitet imenika na slušalici 500 (imena i brojeva)
- alarm, sat, izbornik na lokalnim jezicima
- 11 sati razgovora
- koristi baterije Ni-MH (AAx2)
- dimenzije baze: 116x92x31 mm
- dimenzije slušalice: 47x35x153 mm
- šifra: **000031724**

Panasonic**Bežični telefon KX-PRS110FXW**

- prikaz broja pozivatelja (Caller ID)
- TFT zaslon u boji od 2,2 inch
- frekvencija: 1,9 GHz
- mogućnost umrežavanja do 6 slušalica i mogućnost umrežavanja do 4 baze
- kapacitet imenika na slušalici 300 (imena i brojeva)
- memorija za brojeve 50 primljenih poziva
- alarm, sat, izbornik na lokalnim jezicima
- blokiranje odlaznih/dolaznih poziva u svrhu smanjenja broja neželjenih poziva
- 12 sati razgovora
- koristi baterije Ni-MH (AAx2)
- dimenzije baze: 78x52x80 mm
- dimenzije slušalice: 47x26x145 mm
- šifra: **000023751**



TELEFONI

Panasonic**Bežični telefon KX-TGC220FXB**

- 18 min sekretarica s brojačem poruka
- prikaz broja pozivatelja (Caller ID)
- LCD zaslon od 1,6 inča
- frekvencija: 1,9 GHz
- kapacitet imenika na slušalici 50 (imena i brojeva)
- alarm, sat, izbornik na lokalnim jezicima
- 16 sati razgovora
- koristi baterije Ni-MH (AAAx2)
- dimenzije baze: 107x96x77 mm
- dimenzije slušalice: 47x30x164 mm
- šifra: **000025877**

**Panasonic****Bežični telefon KX-TGC210FX**

- prikaz broja pozivatelja (Caller ID)
- LCD zaslon od 1,6 inča
- frekvencija: 1,9 GHz
- kapacitet imenika na slušalici 50 (imena i brojeva)
- alarm, sat, izbornik na lokalnim jezicima
- 16 sati razgovora
- koristi baterije Ni-MH (AAAx2)
- dimenzije baze: 107x96x77 mm
- dimenzije slušalice: 47x30x164 mm
- šifra: **000029371**

**Panasonic****Bežični telefon KX-TGE210FX**

- prikaz broja pozivatelja (Caller ID)
- LCD zaslon od 1,8 inča
- frekvencija: 1,9 GHz
- mogućnost umrežavanja do 6 slušalica
- kapacitet imenika na slušalici 150 (imena i brojeva)
- alarm, sat, izbornik na lokalnim jezicima
- 16 sati razgovora
- koristi baterije Ni-MH (AAAx2)
- dimenzije baze: 138x88x80 mm
- dimenzije slušalice: 54x31x171 mm
- šifra: **000026689**

**Panasonic****Bežični telefon KX-TG1611 FX**

- 12-znakovni zaslon
- prikaz broja pozivatelja (Caller ID)
- kapacitet imenika na slušalici 50 (imena i brojeva)
- izbornik na lokalnim jezicima
- dimenzije baze: 100x50x90 mm
- dimenzije slušalice: 30x159x49 mm
- šifra: **000019239**



ETIKETIRKE

**fornax****Etiketirka**

- dvoredni ispis na 1 etiketu
- za etikete dimenzije 26x16 mm
- oznake: KM, KN, EUR
- pakiranje: 1
- šifra: **000019911**

**Etiketirka Smart**

- jednoredni ispis na 1 etiketu
- za etikete dimenzije 22x12 mm
- oznake: KM, KN, EUR
- pakiranje: 1
- šifra: **000019905**

ETIKETE ZA ETIKETIRKE



VIDJETI NA STR. 88

VALJČIČI

Valjčić nakvasni Printex

- služi za etiketirke Smart
- pakiranje: 5
- šifra: **000019909**

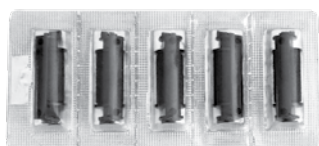
**fornax****Valjčić nakvasni**

- služi za etiketirke Fornax
- pakiranje: 5
- šifra: **000021401**



DYMO**Aparat LabelManager 420P**

- prijenosni, spaja se s USB-om
- veliki LCD zaslon u 4 reda s pozadinskim osvjetljenjem koji pokazuje tekstulani efekat na zaslonu prije ispisa
- aparat spojite na svoj PC ili Mac i koristite DYMO Label™ softver koji je dizajniran za naljepnice na zaslonu računala, tako možete ispisati barkodove, logotipe, grafike ili ispisati serije naljepnica iz teksta u proračunske tablice ili baze podataka datoteke
- koristi standardne, permanentne i fleksibilne D1 trake
- koristi D1 etikete širine: 6, 9, 12 i 19 mm
- automatsko gašenje uređaja
- 8 vrsta fonta, 7 veličina fonta, 10 tekst stilova, 8 vrsta okvira
- ugrađena memorija sprema zadnju naljepnicu
- rezanje trake: ručno, te se lako odljepljuje
- napajanje: Li-ion baterija
- dimenzija: 215x111x57 mm
- težina 500 g
- pakiranje: 1
- šifra: **000022815**

**DYMO****Aparat LabelManager 160**

- plastično kućište
- aparat spojite na svoj PC ili Mac i koristite DYMO Label™ softver koji je dizajniran za naljepnice na zaslonu računala, tako možete ispisati barkodove, logotipe, grafike ili ispisati serije naljepnica iz teksta u proračunske tablice ili baze podataka datoteke
- koristi standardne, permanentne i fleksibilne D1 trake
- koristi D1 etikete širine: 6, 9 i 12 mm
- automatsko gašenje uređaja
- 6 veličina fonta, 8 tekst stilova, 4 vrste okvira i podcrtavanje
- ugrađena memorija sprema zadnju naljepnicu
- QWERTZ tipkovnica
- rezanje trake: ručno, te se lako odljepljuje
- napajanje: 6 x AAA baterije
- dimenzija: 203x118x49 mm
- težina 350 g
- pakiranje: 1
- šifra: **000025451**

**DYMO****Aparat LetraTAG LT-100H**

- plastično kućište
- veliki LCD zaslon 30x10 mm
- max. print visina: 4 mm
- koristi plastične, papirnate, metalizirane te termalne LT trake
- koristi LT etikete širine 12 mm x 4 mm
- postav tipkovnice: ABC, broj tipki: 40
- broj znakova/simbola: 154
- rezolucija tiska (tpi): 160
- max. redaka ispisa: 2
- brzina tiska (mm/sek): 6,8
- proces tiska: termo-izravno
- 2 veličine fonta, 7 tekst stilova, 5 vrsta okvira i podcrtavanje
- ugrađena memorija sprema zadnju naljepnicu
- rezanje trake: ručno, te se lako odljepljuje
- napajanje: 6 x AA baterije
- dimenzija: 79x65x210 mm
- težina 300 g
- pakiranje: 1
- šifra: **000004267**





Trake Dymo LetraTAG

- koristi se samo za aparate LetraTAG
- traka može biti: papirna, plastična i metalizirana
- lako se uklanja tekst s trake
- dimenzija: 12mm x 4m
- pakiranje: 10

Šifra	Opis	Boja trake	Boja ispisa
000004270	metalizirana		crna
000004268	papirna		crna
000004269	plastična		crna
000020603	plastična		crna
000025145	plastična		crna



Trake Dymo D1

- koristi se za aparate: LabelPoint 200, LabelPoint 250, LabelPoint 300, LabelManager 120P, LabelManager 150, LabelManager 210D, LabelManager 350, LabelManager 400, LabelManager 450D, LabelManager PC
- traka je samoljepljiva i dugotrajna
- može se lijepiti na gotovo sve ravne i čiste površine (papir, plastika, metal, drvo, staklo)
- može se odljepiti tako da ne ostavlja tragove
- ima prerez na poledini vrpce radi lakšeg uklanjanja podloge
- otporna je na: UV zrake, vodu, ulje i mast
- podnosi temperature -30° do +150°C
- dimenzija: 12mm x 7m
- pakiranje: 5

Šifra	Boja trake	Boja ispisa
000020049		plava
000019847		crvena
000019846		crna
000001745		crna
000020048		crna
000019980		crna





SIGURNOSNA RJEŠENJA ZA EFIKASNO RUKOVANJE NOVCEM

ZAŠTITITE SE OD PRIMANJA KRIVOTVORENOG NOVCA

U našem svijetu koji se sve više tehnološki razvija, sve je lakše stvoriti sofisticirane krivotvorine koje ljudsko oko nikada neće moći uočiti - ali hoće Safescanovi automatski detektori lažnih novčanica koristeći najnoviju tehnologiju detekcije u više točaka sa dokazanom 100% točnošću. Naši vrhunski detektori su toliko napredni da će čak otkriti tzv. "Superdolar", najsoficiraniju krivotvorenu novčanicu ikada stvorenu. Nema boljeg načina da zaštitite svoju tvrtku i posao od krivotvorenog kriminala.

BRZO I TOČNO BROJANJE SA DETEKCIJOM KRIVOTVORINA U SEDAM TOČAKA

Safescan pruža profesionalno brojanje novčanica uz izvrsne rezultate. Nudimo cijeli niz brojača novčanica kako bi odgovarali bilo kojoj aplikaciji: od velikih i brzih brojača (sa prednjim i zadnjim ubacivanjem novčanica) do integriranih rješenja koja kombiniraju prebrojavanje i razvrstavanje inteligentnim otkrivanjem krivotvorina kako bi korisniku uštedjeli vrijeme i osigurali autentičnost.



Flomaster za otkrivanje lažnih novčanica 30

- služi za trenutnu provjeru lažnih novčanica
- pogodan za KM i sve ostale valute
- pakiranje: 1
- šifra: **000024097**



Aparat za otkrivanje lažnih novčanica 35

- 3 opcije provjere lažnih novčanica
- služi za trenutnu provjeru lažnih novčanica
- pogodan za KM i sve ostale valute
- uključuje traku za nošenje i baterije (4 x LR44)
- pakiranje: 1
- šifra: **000024098**



Aparat za otkrivanje lažnih novčanica 50

- UV lampa s trostruko dužim vijekom trajanja
- pogodan za KM i sve ostale valute
- prepoznaje kreditne kartice, putovnice i ostale identifikacijske dokumente
- pakiranje: 1
- šifra: **000024099**



Aparat za otkrivanje lažnih novčanica 70

- UV lampa s trostruko dužim vijekom trajanja
- pogodan za KM i sve ostale valute
- prepoznaje kreditne kartice, putovnice i ostale identifikacijske dokumente
- LED svjetlo omogućuje prepoznavanje vodenog žiga
- automatski senzor za paljenje/gašenje
- pakiranje: 1
- šifra: **000024100**



Aparat za otkrivanje lažnih novčanica MD 1982V

- služi za otkrivanje lažnih novčanica
- aparat sadži: 2x6W plave fluorescentne UV lampe na vrhu i 1x6W fluorescentnu lampu za danje svjetlo za skeniranje
- dimenzije: 270x140x135mm
- pakiranje: 1
- šifra: **000002446**



Aparat za otkrivanje lažnih novčanica MD 3217

- služi za otkrivanje lažnih novčanica, kreditnih kartica, čekova, putnih dokumenata, markica
- značajka ovog aparata je UV fluorescentna lampa velike snage, koja omogućuje i korištenje danju
- novi dizajn potpuno štiti oči prilikom korištenja
- nakon što se aparat upali, 30 sekundi je potrebno da počne normalno obavljati zadane operacije
- pakiranje: 1
- šifra: **000003955**

**Brojač novca 2210**

- s UV lampom za otkrivanje lažnih novčanica
- broji 1000 novčanica u minuti
- pogodan za KM i sve ostale valute
- pakiranje: 1
- šifra: **000024101**

**Brojač novca 2665**

- s automatskim otkrivanjem lažnih novčanica
- veliki kapacitet brojanja novčanica
- broji 1500 novčanica u minuti
- pogodan za KM i sve ostale valute
- pakiranje: 1
- šifra: **000024103**

**Brojač kovanica 1250**

- broji i sortira 250 kovanica u minuti
- automatsko zaustavljanje kad je ladica puna
- kapacitet: 200-500 kovanica
- valuta: euro
- dimenzija: 355x330x266 mm
- pakiranje: 1
- šifra: **000032008**

**Brojač kovanica 1550**

- broji 2300 sortiranih kovanica u minuti
- kapacitet: 5000 kovanica
- valuta: KM, euro i ostale
- dimenzija: 268x360x196 mm
- pakiranje: 1
- šifra: **000029579**

LADICE ZA NOVAC

**Ladica za novac SD-4617S**

- sa 6 vertikalnih odjeljaka za papirni novac i 8 odjeljaka za kovanice
- kompatibilna s kasama
- električno i ručno otvaranje
- dimenzija: 460x170x100 mm
- pakiranje: 1
- šifra: **000032234**





Ladica za novac LD-4141

- s 4 odjeljka za papirni novac i 8 odjeljaka za kovanice
- s jakim metalnim klipsama za papirni novac
- kompatibilna s kasama i računalima
- električno i ručno otvaranje
- dimenzija: 410x415x115 mm
- pakiranje: 1
- šifra: **000032233**



Ladica za novac SD-4141

- s 4 odjeljka za papirni novac i 8 odjeljaka za kovanice
- s jakim metalnim klipsama za papirni novac
- ručno otvaranje
- dimenzija: 161x163x45 mm
- pakiranje: 1
- šifra: **000032232**



Ladica za novac SD-3540

- s 4 odjeljka za papirni novac i 8 odjeljaka za kovanice
- s jakim metalnim klipsama za papirni novac
- kompatibilna s kasama
- ručno otvaranje
- dimenzija: 138x157x410 mm
- pakiranje: 1
- šifra: **000032235**



VREĆICE SIGURNOSNE ZA TRANSPORT NOVCA



VIDJETI NA STR. 85



Rezervna žarulja UV 50/70

- služi za aparate za otkrivanje lažnih novčanica Safescan 50/70
- snaga žarulje: 220V-240V
- pakiranje: 1
- šifra: **000024106**

Na Vaš upit i prema Vašim zahtjevima, možemo ponuditi razne pisače i multifunkcionalne uređaje poznatih brand-ova.





Se
LA
FOR ALL TYPE

fornax

Self-adhesive LABELS

FOR ALL TYPES OF PRINTERS AND PHOTOCOPIERS

Self-adhesive labels

A4 100 SHEETS

fornax®

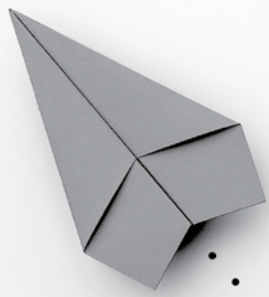



OBJAŠNENJE IKONA

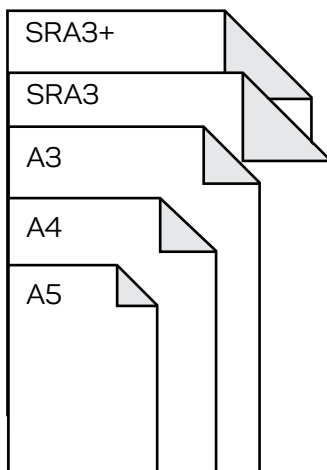

Formati papira:

SRA3+ – 457 x 305 mm

SRA3 – 450 x 320 mm

A3 – 297 x 420 mm

A4 – 210 x 297 mm

A5 – 148 x 210 mm

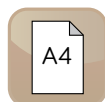
format
papiragramatura
papiralistova
u rizmirizmi
u paketu

FABRIANO

Papir Eminence 80

- visoko kvalitetni papir
- proizveden od 100 % čiste E.C.F. celuloze
- izrazite bjeline
- idealan za obostrano fotokopiranje, laserski i inkjet ispis, te faksiranje
- šifra A4: **000011375**



FABRIANO

Papir Eminence 90

- visoko kvalitetni papir
- proizveden od 100 % čiste E.C.F. celuloze
- izrazite bjeline
- idealan za obostrano fotokopiranje, laserski i inkjet ispis, te faksiranje
- šifra A4: **000024457**



FABRIANO

Papir Eminence 100

- visoko kvalitetni papir
- proizveden od 100 % čiste E.C.F. celuloze
- izrazite bjeline
- idealan za obostrano fotokopiranje, laserski i inkjet ispis, te faksiranje
- šifra A4: **000024458**



FABRIANO

Papir Copy 1

- papir izvrsne kvalitete
- proizveden od 100 % čiste E.C.F. celuloze
- vrlo visoke bjeline
- idealan za obostrano fotokopiranje, laserski i inkjet ispis, te faksiranje
- šifra A4: **000000818**
- šifra A3: **000000091**





FABRIANO

Papir Copy 2

- optimalna kvaliteta
- proizveden od 100 % čiste E.C.F. celuloze
- visoki stupanj bjeline
- idealan za obostrano fotokopiranje
- šifra A4: **000000254**
- šifra A3: **000000255**



foroffice®

Papir Deluxe

- papir dobre kvalitete
- proizveden od 100 % čiste E.C.F. celuloze
- vrlo visoke bjeline
- idealan za obostrano fotokopiranje, laserski i inkjet ispis, te faksiranje
- šifra A4: **000008750**
- šifra A3: **000000509**



FABRIANO

Papir Copy Life

- optimalna kvaliteta
- proizveden od recikliranog papira
- idealan za obostrano fotokopiranje, laserski i inkjet ispis, te faksiranje
- šifra A4: **000000510**



FABRIANO

Papir Copy Bio

- optimalna kvaliteta
- ekološki papir proizveden bez klora
- idealan za obostrano fotokopiranje, laserski i inkjet ispis, te faksiranje
- šifra A4: **000010074**



Release your
creativity.



STAEDTLER®





FABRIANO

Papir za digitalni tisak Multipaper

- nepremazni papir
- izvrsne bjeline
- ravne površine: glossy efekt
- idealan za laserski i inkjet ispis u boji

Šifra	Format	Gramatura (g/m ²)	Listova u rizmi	Rizmi u paketu
000022314	A4	90	500	4
000006729	A3	90	500	4
000005015	A4	100	500	4
000006253	A3	100	500	4
000009424	A4	120	250	5
000009422	A3	120	250	4
000006730	A4	140	250	5
000006726	A3	140	250	4
000006727	A4	160	250	5
000006815	A3	160	250	4
000006763	A4	200	250	4
000006764	A3	200	250	4
000009425	A4	240	150	5
000009423	A3	240	150	4
000015143	A4	300	125	5
000015145	A3	300	125	5
000015144	A4	350	125	4
000015146	A3	350	125	4

FABRIANO

Papir za digitalni tisak Multipaper

- nepremazni papir
- izvrsne bjeline
- ravne površine: glossy efekt
- idealan za laserski i inkjet ispis u boji



Šifra	Dim. (cm)	Gramatura (g/m ²)	Listova u rizmi	Rizmi u paketu
000014329	45 x 32	100	500	4
000014330	45 x 32	120	250	5
-	45 x 32	140	250	5
000014331	45 x 32	160	250	5
000014332	45 x 32	200	250	4
000023484	45 x 32	240	150	5
000014333	45 x 32	300	125	5
000014334	45 x 32	350	125	4

FABRIANO

Papir Elle Erre

- papir u boji s dva lica
- jedna strana glatka, a druga hrapava
- idealan za sve vrste crtanja i tehnike tiska
- format: B1,
- gramatura 220 g/m²
- pakiranje: 10

Šifra	Opis
600000497	old white
600000091	bianco
600000092	panna
600000093	perla
600000302	avana
600000094	viola
600000095	marrone
600000096	giallo
600000097	arancio
600000098	rosso
600000099	verde pisello
600000100	verde
600000101	azzurro
600000102	blu
600000416	nero
600000103	rosa
600000104	onice
600000105	celeste
600000106	tera bruciata
600000107	cielo
600000109	ferro
600000110	fucsia
600000132	cedro
600000133	aragosta
600000410	ciliegia
000010124	verdone
600000442	brina
600000459	china



FABRIANO

Papir Copy tinta

- nepremazni papir, obostrano obojen
- proizveden od 100 % čiste E.C.F. celuloze
- optimalna kvaliteta
- dobar za obostrano fotokopiranje, laserski i inkjet ispis, te faksiranje

Naziv	A4 - 80g/m ² 500 listova u rizmi	A3 - 80g/m ² 250 listova u rizmi	A4 - 160g/m ² 250 listova u rizmi	A3 - 160g/m ² 125 listova u rizmi	A4 - 200g/m ² 100 listova u rizmi
Raspoložive boje	šifra	šifra	šifra	šifra	šifra
verde	000006810	000006812	-	-	000005240
verde pisello	000007222	000007228	-	-	000005243
azzurro	000006814	000007213	-	-	000005241
aragosta	000007217	000007218	-	-	000005242
rosso	000007214	000007215	000013343	000000658	000000508
giallo	000006941	000007216	000013342	000000651	000005238
fucsia	000011376	000011384	-	-	-
violetta	000011377	000011385	-	-	-
cielo	000011378	000011386	-	-	-
celeste	000006937	000006938	000013341	000000654	000005252
lavanda	000006807	000006808	-	-	-
avorio	000006939	000006940	000013339	-	-
cedro	000006731	000006809	-	000011015	-
banana	000002568	000007220	000013340	000000661	-
aquamarina	000006157	000007219	-	-	-
albicoca	000006908	000007221	-	-	-
rosa	000006811	000006813	-	000000662	000005254
cipria	000011379	000011387	-	-	-
verde chiaro	000011380	000011388	-	-	-
onice	000011381	000011389	-	-	000005249
celeste chiaro	000011382	000011390	-	-	-
grigio	000011383	000011391	-	-	-
nero	-	-	-	-	000011392
bianco	-	-	-	-	000005248

FABRIANO

Papir Copy tinta mix boja

- nepremazni papir, obostrano obojen
- proizveden od 100 % čiste E.C.F. celuloze
- optimalna kvaliteta
- podoban za obostrano fotokopiranje, laserski i inkjet ispis, te faksiranje
- 5 boja po 50 listova, 250 listova u rizmi



Šifra	Format	Boje	Opis	Gramatura (g/m ²)	Rizmi u paketu
00003966	A4		tamna mješavina	80	10
000014051	A3		tamna mješavina	80	8
00003962	A4		svijetla mješavina	80	10
000014052	A3		svijetla mješavina	80	8

- 5 boja po 20 listova, 100 listova u rizmi

Šifra	Format	Boje	Opis	Gramatura (g/m ²)	Rizmi u paketu
000005034	A4		tamna mješavina	200	10
000004266	A4		svijetla mješavina	200	10

FOTO PAPIRI



Foto papir

- matt papir
- jamči visoku kvalitetu ispisa
- pruža nenadmašnu oštrinu slike, visoki kontrast, zasićenost boja i precizno fotografsko renderiranje
- idealan za izradu vizuala za komunikacijske svrhe i za izradu foto albuma
- 100 % kompatibilan sa svim ink jet pisačima
- vrsta: inkjet
- šifra: **000023482**



AS:MARRI

Foto papir Premium

- sjajni papir
- visoka kvaliteta ispisa
- dugi vijek trajanja od tiska tijekom vremena
- idealan za fotografije i grafičke slike
- kompatibilan sa ink jet pisačima
- vrsta: inkjet
- šifra: **000023397**



Foto papir

- za ispis na obje strane, mat premaz
- pogodan za sve pisače
- suši se odmah
- šifra: **000025322**

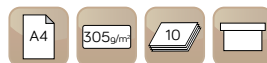

Foto papir

- za ispis na obje strane, visoki sjaj prednja, mat natrag
- pogodan za sve pisače
- šifra: **000025323**





Foto papir

- PE-obložen, visoki sjaj
- pogodan za sve pisaae
- tisak na obje strane
- univerzalno primjenjiv
- instant sušenje
- šifra: **000025324**

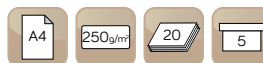

FABRIANO

Papir Writech Sopraffino Avorio

- papir sa vodenim znakom
- boja slonovače, glatke površine sa blagim linijama
- za laserski i inkjet ispis
- proizveden od 100 % čiste E.C.F. celuloze
- idealan za pozivnice, pisma, čestitke, memorandume
- šifra: **000009241**



WRITECH KUVERTE



Fabriano Writech papiri su papiri za posebnu namjenu. Proizvedeni su od 100 % čiste E.C.F. celuloze. Namijenjeni su za pozivnice, čestitke, memorandume... Za ove vrste papira imamo u ponudi i Writech kuverte.



VIDJETI NA STR. 79



FABRIANO

Papir Writech Ingres

- papir sa vodenim znakom
- za laserski i inkjet ispis
- proizveden od 100 % čiste E.C.F. celuloze
- idealan za pozivnice, pisma, čestitke, memorandume



FABRIANO

Papir Writech Rusticus

- nepremazni papir
- blago hrapave površine
- jedinstvena kvaliteta
- za laserski i inkjet ispis
- proizveden od 100 % čiste E.C.F. celuloze
- idealan za pozivnice, pisma, čestitke, memorandume



Šifra	Naziv
000009251	ghiaccio
000009253	gialletto
000009254	verde chiaro

Šifra	Naziv
000009243	bianco
000009245	camoscio
000009246	sabbia



FABRIANO

Papir Writech Fabria

- nepremazni papir
- jedinstven, inovativan
- za laserski i inkjet ispis
- proizveden od 100 % čiste E.C.F. celuloze
- idealan za pozivnice, pisma, čestitke, memorandum

Šifra	Naziv
000009259	bianco
000009260	avorio
000009261	brizzato



FABRIANO

Papir Writech Pergamena

- nepremazni pergamentni papir
- prestižna i jedinstvena kvaliteta
- za laserski i inkjet ispis
- proizveden od 100 % čiste E.C.F. celuloze
- idealan za pozivnice, pisma, čestitke, memorandum

Šifra	Naziv
000009267	bianco
000009268	avorio



FABRIANO

Papir rola za ploter

- nepremazni papir visoke bjeline; 80 g/m²

Šifra	Dimenzija (mm x m)	Pakiranje
000014184	297 x 50	3
000014185	325 x 50	3
000014186	420 x 50	1
000014187	594 x 50	1
000009426	610 x 50	1
000014188	841 x 50	1
000009427	914 x 50	1
000014183	1067 x 50	1

fornax

Papir rola za ploter

- nepremazni papir visoke bjeline; 80 g/m²

Šifra	Dimenzija (mm x m)	Pakiranje
000013468	297 x 50	1
000013469	325 x 50	1
000013470	420 x 50	1
000013471	594 x 50	1
000019925	610 x 50	1
000020498	750 x 50	1
000013472	841 x 50	1
000019926	914 x 50	1
000013473	1067 x 50	1



Papir rola za ploter

- izvrsna bjelina
- odličan za ispis u boji



Šifra	Naziv	Dimenzija (mm x m)	Opis	Gramatura (g/m ²)	Pakiranje
000006166	C6035A	610 x 45,7	nepremazni mat	90	1
000006776	C6036A	914 x 45,7	nepremazni mat	90	1
000000146	C6020B	914 x 45,7	premazni mat	90	1

fornax**Papir rola za kopiranje**

- nepremazni papir visoke bjeline

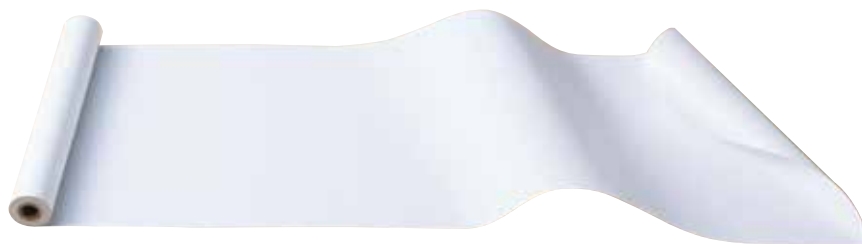

Šifra	Dimenzija (mm x m)	Gramatura (g/m ²)	Pakiranje
000013474	297 x 150	80	1
000013475	325 x 150	80	1
000013476	420 x 150	80	1
000025508	420 x 175	80	1
000013477	594 x 150	80	1
000013478	610 x 150	80	1
000025507	620 x 175	80	1
000013479	841 x 150	80	1
000013480	914 x 150	80	1
000025506	914 x 175	80	1
000013481	1067 x 150	80	1
000025310	297 x 150	90	1
000025311	325 x 150	90	1
000025312	420 x 150	90	1
000025313	594 x 150	90	1
000025314	610 x 150	90	1
000025315	841 x 150	90	1
000025316	914 x 150	90	1

PAPIRI KOMPJUTERSKI

**OBJAŠNJENJE VRSTA**

- 1+0 = 1 ispis bez kopije
- 1+1 = 1 ispis i 1 kopija
- 1+2 = 1 ispis i 2 kopije
- 1+3 = 1 ispis i 3 kopije

fornax**Papir kompjuterski**

- koristi se za ispis kod igličastih pisača
- gramatura papira je 60 g/m²

Šifra	Format (cm)	Vrsta	Kopija u pakiranju
000000431	234 x 12	1+0	2000
000000432	234 x 12	1+1	1000
000002548	234 x 12	1+2	750
000000605	234 x 12	1+3	500
000000503	380 x 12	1+0	2000
000000604	380 x 12	1+1	1000
000001312	380 x 12	1+2	750
000000601	380 x 12	1+3	500

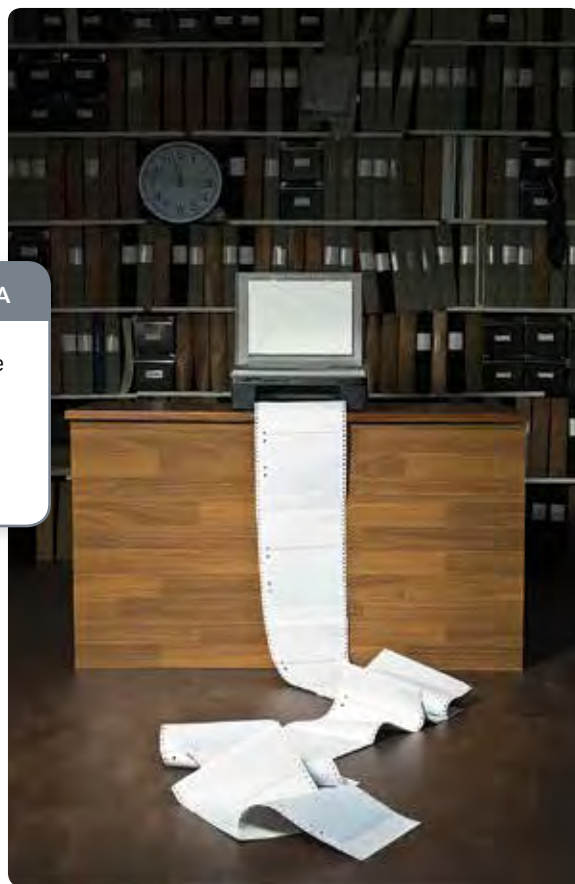

ROLE ADING



fornax

Rola ading

- koriste blagajne i PC kase

Šifra	Širina (mm)	Ø	Vrsta
000000310	57	Ø12	1+0
000000541	57	Ø12	1+1
000001309	70	Ø12	1+1
000001008	76	Ø12	1+0
000001973	76	Ø12	1+1
000000008	82	Ø12	1+1

fornax

Rola ading termo

- rade na principu topline aparata
- koriste blagajne i PC kase

Šifra	Širina (mm)	Namotaj (m)
000017265	20	17
000013370	28	17
000005971	28	30
000017266	35	17
000012191	38	30
000023541	57	12
000004297	57	30
000025235	57	35
000013372	58	35
000013373	58	50
000013374	58	60
000017617	59	35
000019161	59	50
000019162	59	60
000003464	76	30
000009133	76	50
000019181	79	45
000017657	79	50
000010064	79	79
000004298	80	30
000011130	80	60

ROLE TELEFAX

fornax

Rola telefax

- služi za telefax aparate

Šifra	Dimenzija
000001345	21cm x 30m
000001313	21cm x 50m
000001507	21,6cm x 30m



PAPIRI PAUS



Papir paus

- homogen i glatke prozirne strukture
- papir primjeren za tehničko crtanje, grafite, markere
- format A4 i A3 izuzetne kvalitete za fotokopiranje

Šifra	Format	Gramatura (g/m ²)	Pakiranje
000001462	A4	90	500 listova
000001461	A3	90	250 listova
000001503	65cm x 20m	75	rola
000000828	91cm x 20m	75	rola
000001600	110cm x 20m	75	rola



**Indigo papir**

- koristi se za preslikavanje s jednog papira na drugi
- ručni
- plave boje
- format: A4
- pakiranje: 100/1

Šifra	Opis	Boja
000020371	ručni Pelikan 200H	plava
000011263	ručni Pelikan 205	plava

**fornax****Indigo papir**

- koristi se za preslikavanje s jednog papira na drugi
- crne i plave boje
- strojni i ručni
- format: A4
- pakiranje: 100/1

Šifra	Opis	Boja
000023416	ručni papirni	plava
000023415	ručni plastificirani	plava
000023414	strojni plastificirani	crna

KUVERTE WRITECH

**FABRIANO****Kuverta Writech Sopraffino**

- papir sa vodenim znakom
- boja slonovače, glatke površine sa blagim linijama
- za laserski i inkjet ispis
- proizveden od 100 % čiste E.C.F. celuloze



Šifra	Boja	Dimenzija (cm)
000009242	avorio	11 x 22

**FABRIANO****Kuverta Writech Ingres**

- papir sa vodenim znakom
- za laserski i inkjet ispis
- proizveden od 100 % čiste E.C.F. celuloze



Šifra	Boja	Dimenzija (cm)
000009255	ghiaccio	11 x 22
000009257	gialletto	11 x 22
000009258	verde chiaro	11 x 22



WRITECH PAPIRI



VIDJETI NA STR. 75

FABRIANO



FABRIANO

Kuverta Writech Rusticus

- nepremazni papir, blago hrapave površine
- jedinstvena kvaliteta
- za laserski i inkjet ispis
- proizveden od 100 % čiste E.C.F. celuloze



Šifra	Boja	Dimenzija (cm)
000009247	bianco	11 x 22
000009248	neve	11 x 22
000009249	camoscio	11 x 22
000009250	sabbia	11 x 22



FABRIANO

Kuverta Writech Pergamenata

- nepremazni pergamentni papir
- prestižna i jedinstvena kvaliteta
- za laserski i inkjet ispis
- proizveden od 100 % čiste E.C.F. celuloze



Šifra	Boja	Dimenzija (cm)
000009269	bianco	11 x 22
000009270	avorio	11 x 22



FABRIANO

Kuverta Writech Fabria

- nepremazni papir
- jedinstven, inovativan
- za laserski i inkjet ispis
- proizveden od 100 % čiste E.C.F. celuloze



Šifra	Boja	Dimenzija (cm)	Pakiranje
000009263	bianco	11 x 22	100
000009264	avorio	11 x 22	100
000009265	brizzato	11 x 22	100
000009266	brizzato neve	11 x 22	100
000006765	bianco	11 x 22	500
000006766	avorio	11 x 22	500
000006767	brizzato	11 x 22	500
000007933	brizzato neve	11 x 22	500
000011969	avorio	12 x 18	500
000011250	bianco	12 x 18	500
000006460	avorio	16 x 23	500
000006770	bianco	16 x 23	500
000006769	brizzato	16 x 23	500
000006771	crema	16 x 23	500



Kuverta

Šifra	Boja	Opis dimenzije	Dimenzija (mm)	Način ljepljenja	Pakiranje
-		C6	114 x 162	gumirana	1000
000006753		C6	114 x 162	gumirana	1000

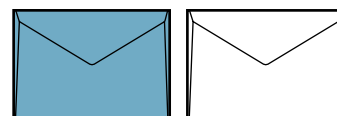

Šifra	Boja	Opis dimenzije	Dimenzija (mm)	Način ljepljenja	Pakiranje
000002454		B6	120 x 176	gumirana	1000
000002455		B6	120 x 176	gumirana	1000
000015259		B6	120 x 176	gumirana	25
000015265		B6	120 x 176	gumirana	25

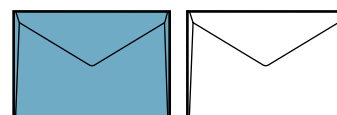

Šifra	Boja	Opis dimenzije	Dimenzija (mm)	Način ljepljenja	Pakiranje
00003385		B6	120 x 176	strip	1000
00007745		B6	120 x 176	strip	1000
000015264		B6	120 x 176	strip	25
000015266		B6	120 x 176	strip	25

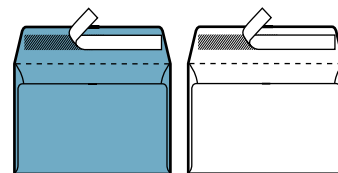

Kuverta s dostavnicom

Šifra	Boja	Opis dimenzije	Dimenzija (mm)	Način ljepljenja	Pakiranje
000010717		B6	125 x 176	gumirana	1000
00000334		B6	125 x 176	gumirana	1000

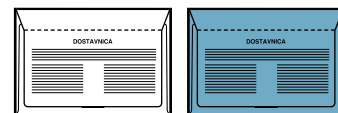

Kuverta za automatsko punjenje

Šifra	Boja	Opis dimenzije	Dimenzija (mm)	Način ljepljenja	Pakiranje
000006572		C6/5	114 x 229	gumirana	1000
000008699		C6/5 PL	114 x 229	gumirana	1000
000000597		C6/5 PD	114 x 229	gumirana	1000

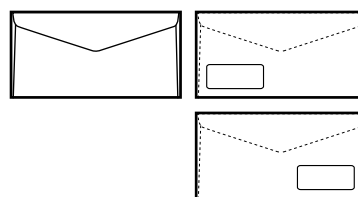

Kuverta american

Šifra	Boja	Opis dimenzije	Dimenzija (mm)	Način ljepljenja	Pakiranje
000002466		ABT	114 x 229	strip	1000
000002448		ABT PL	114 x 229	strip	1000
000002469		ABT PD	114 x 229	strip	1000
000015267		ABT	114 x 229	strip	25
000015268		ABT PL	114 x 229	strip	25
000015269		ABT PD	114 x 229	strip	25

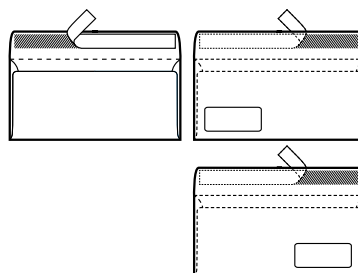

O KUVERTAMA

Veličina kuverta po namjeni upotrebe

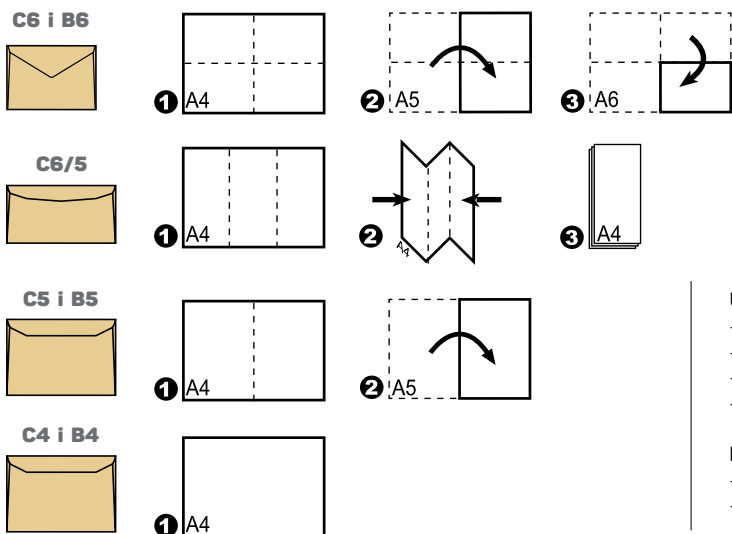

Nosimo Vaše poruke...



- U našoj ponudi nudimo raznolik asortiman kuverta:
- raznih veličina
 - boja
 - načina ljepljenja
 - s prozorom (desni ili lijevi) ili bez prozora

- Način ljepljenja:**
- strip = s ljeplilom ispod zaštitne trake
 - gumirana = s ljeplilom koje je potrebno navlažiti



Mogućnost personalizacije, u više boja, na svim vrstama kuverta.

* Razlika između kuverta oznake **C** i **B** je u tome što je kuverta varijante **B** proširenog formata, pa u nju može stati više papira, u odnosu na kuvertu varijante **C**.

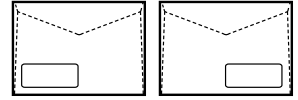

Kuverta

Šifra	Boja	Opis dimenzije	Dimenzija (mm)	Način ljepljenja	Pakiranje
000001704		C5 PL	162 x 229	gumirana	1000
-		C5 PD	162 x 229	gumirana	1000

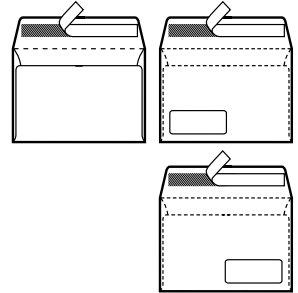

Šifra	Boja	Opis dimenzije	Dimenzija (mm)	Način ljepljenja	Pakiranje
000009957		C5	162 x 229	strip	1000
000009956		C5 PL	162 x 229	strip	1000
000009504		C5 PD	162 x 229	strip	1000



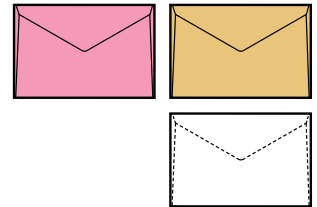

Šifra	Boja	Opis dimenzije	Dimenzija (mm)	Način ljepljenja	Pakiranje
000002071		B5	176 x 250	gumirana	1000
000002449		B5	176 x 250	gumirana	1000
000003169		B5	176 x 250	gumirana	1000



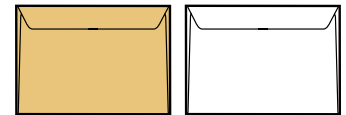

Šifra	Boja	Opis dimenzije	Dimenzija (mm)	Način ljepljenja	Pakiranje
000010116		C4	229 x 324	gumirana	250
000010117		C4	229 x 324	gumirana	250



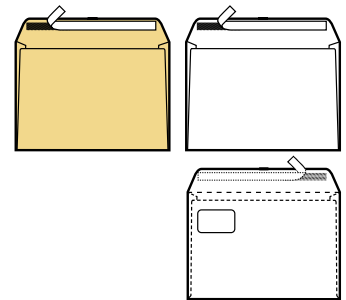

Šifra	Boja	Opis dimenzije	Dimenzija (mm)	Način ljepljenja	Pakiranje
000010118		C4	229 x 324	strip	250
000010119		C4	229 x 324	strip	250
000016861		B4	250 x 353	strip	250

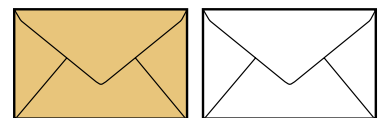

Šifra	Boja	Opis dimenzije	Dimenzija (mm)	Način ljepljenja	Pakiranje
000000208		1000-AD	230 x 360	gumirana	500
-		1000-BB	230 x 360	gumirana	500



Šifra	Boja	Opis dimenzije	Dimenzija (mm)	Način ljepljenja	Pakiranje
000016718		17B SI	176 x 176	strip	1000
000016719		22B SI	220 x 220	strip	1000

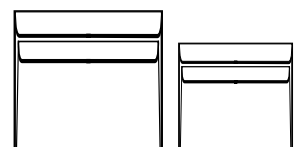

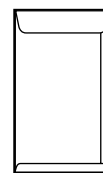

Kuverta vrećica isplatna

Šifra	Boja	Opis dimenzije	Dimenzija (mm)	Način ljepljenja	Pakiranje
00001409		-	120 x 200	gumirana	1000





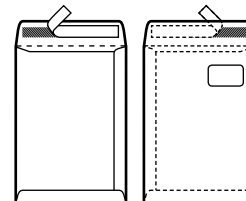

Kuverta vrećica

Šifra	Boja	Opis dimenzije	Dimenzija (mm)	Način ljepljenja	Pakiranje
00005074		C5	162 x 229	strip	1000
00000596		C5 PD	162 x 229	strip	1000
000015270		C5	162 x 229	strip	25

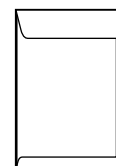





Šifra	Boja	Opis dimenzije	Dimenzija (mm)	Način ljepljenja	Pakiranje
00007452		B5	176 x 250	gumirana	1000

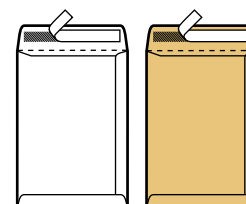



Šifra	Boja	Opis dimenzije	Dimenzija (mm)	Način ljepljenja	Pakiranje
000010022		B5	176 x 250	strip	1000
-		B5	176 x 250	strip	1000
000015271		B5	176 x 250	strip	25
000027870		B5	176 x 250	strip	25



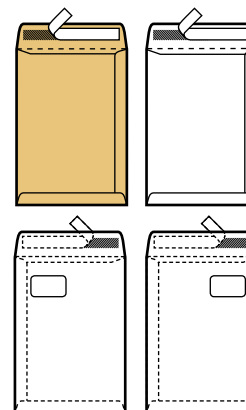

Šifra	Boja	Opis dimenzije	Dimenzija (mm)	Način ljepljenja	Pakiranje
000009749		C4	229 x 324	strip	250
000002281		C4	229 x 324	strip	250
000000464		C4 PL	229 x 324	strip	250
000012709		C4 PD	229 x 324	strip	250
000015272		C4	229 x 324	strip	25

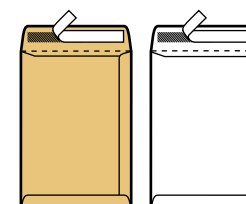

Kuverta vrećica

Šifra	Boja	Opis dimenzije	Dimenzija (mm)	Način ljepljenja	Pakiranje
000009747		B4	250 x 353	strip	250
000009748		B4	250 x 353	strip	250



Šifra	Boja	Opis dimenzije	Dimenzija (mm)	Način ljepljenja	Pakiranje
000009955		400	300 x 400	strip	250
000009814		400	300 x 400	strip	250

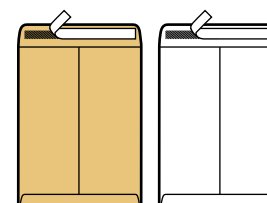



Kuverta sa zračnim jastukom

• koristi se za pohranjivanje i slanje osjetljivih i lako lomljivih predmeta

Šifra	Boja	Dimenzija (mm)	Oznaka	Način ljepljenja	Pakiranje
000003671		120 x 210	B	strip	1
000001829		150 x 210	C	strip	1
000019461		180 x 200	AK-CD	strip	1
000001161		180 x 260	D	strip	1
000000092		220 x 260	E	strip	1
000001831		240 x 330	G	strip	1
000000741		270 x 360	H	strip	1
000000754		300 x 440	J	strip	1
000001153		350 x 480	K	strip	1



VELIČINA KUVERTE PO NAMJENI UPOTREBE

C6 i B6

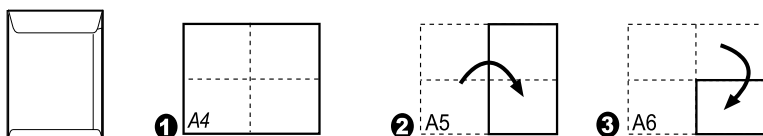

C5 i B5

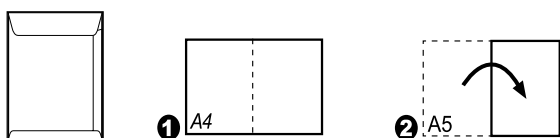

C4 i B4

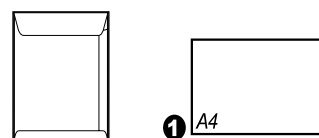

* Razlika između kuverata oznake **C** i **B** je u tome što je kuverta varijante **B** proširenog formata, pa u nju može stati više papira, u odnosu na kuvertu varijante **C**.

FOLIJE SA ZRAČNIM JASTUCIMA

Folija sa zračnim jastucima

- folija sa zračnim jastucima je pakirna ambalaža male gustoće, pripremljena od polietilena, ambalaža koja je laka i fleksibilna. Idealna je za pakiranje lomljivih proizvoda odnosno proizvoda koji su nepravilnog oblika. Osigurava visokokvalitetnu površinsku zaštitu, smanjuje utjecaj udara i trenja. Pogodna je i kao materijal za ispunjenje prostora.
- laka i mekana
- prozirna i otporna na vodu
- može se reciklirati
- smanjuje vrijeme pakiranja
- posebno dobra otpornost na vlagu
- štiti od ogrebotina i udaraca

Šifra	Dimenzija (m)	Pakiranje
000006077	0,5 x 7,5	rola
000031936	0,625 x 200	rola
000015855	1 x 200	rola
000024541	1,25 x 200	rola





Lipa Mill

Vrećice za dokumente

- prozirna PVC vrećice s trakom za odljepljivanje, samoljepljive
- namjenjena za popratne dokumente uz pošiljke, kartice...
- pakiranje: 100/1

Šifra	Dimenzija (cm)
000026381	17,5 x 12,5
000022677	23,5 x 17,5
000022678	32,5 x 23,5

Lipa Mill

Vrećice za dokumente

- prozirna PVC vrećice sa zip zatvaračem
- namjenjena za popratne dokumente uz pošiljke, kartice...
- pakiranje: 100/1

Šifra	Dimenzija (cm)
000023531	6 x 4
000023532	8 x 6
000023533	10 x 7
000023534	12 x 8
000022679	15 x 10
000022676	17 x 12
000022681	22 x 15
000022682	31 x 22



Vrećica sigurnosna za transport novca

- napravljena od Pe-ld
- sigurnosna vrpca visoke kvalitete otkriva poruku u slučaju neovlaštenog otvaranja
- sigurnosni var i tisak na varu omogućuje maksimalnu sigurnost
- pakiranje: 1000/1

Šifra	Dimenzija (cm)
000033564	18 x 27
000033565	30 x 37



SAMOLJEPLJIVE ETIKETE

Jac

Samoljepljive etikete

- vrhunske kvalitete
- idealne za ispis u laserskim pisačima velike brzine, kao i za inkjet pisače
- boja bijela
- pakiranje: set od 100 listova formata A4

Šifra	Dimenzije (mm)	Etiketa na listu A4
00000687	37 x 14	105
00000684	37,5 x 23,5	60
000009407	38,1 x 21,2	65
00000697	47 x 25	44
00000700	47 x 35	32
00000692	48 x 11,1	104
000009408	52,5 x 30	36
00000705	63 x 38	21
00000710	67 x 10	87
00000720	70 x 25	36
000009409	70 x 36	24
00000721	70 x 41	21
00000726	70 x 48	18
000018202	70 x 50,8	15
000009410	99 x 67	8
000009428	104,5 x 48	12
00000665	104,5 x 140	4

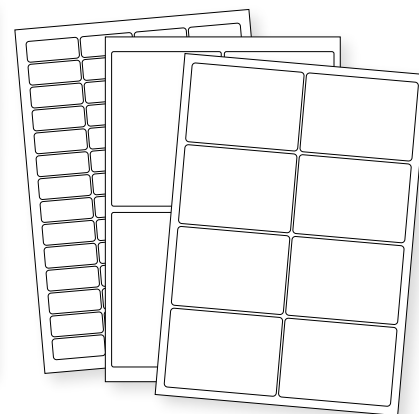

Šifra	Dimenzije (mm)	Etiketa na listu A4
00000670	105 x 36	16
000014691	105 x 57	10
00000672	105 x 72	8
00000678	105 x 74	8
000012084	105 x 99	6
000009388	105 x 148	4
00000682	145 x 17	17
000014963	192 x 61	4
000011292	210 x 148,5	2
000009411	210 x 297	1
00000688	Ø40	28
000009406	Ø117	2

**fornax****Samoljepljive etikete**

- za laser, inkjet, color laser i kopirni stroj
- boja bijela
- pakiranje: set od 100 listova formata A4

Šifra	Dimenzije (mm)	Etiketa na listu A4
000022531	25,4 x 10	189
000033961	37 x 14	105
000033960	37,6 x 23,5	60
000017931	38 x 21,2	65
000033962	47 x 25	44
000033963	47 x 35	32
000017940	48,5 x 16,9	64
000017939	48,5 x 25,4	40
000024714	52,5 x 21,2	56
000017941	52,5 x 29,7	40
000033964	52,5 x 30	36
000033965	63 x 38	21
000022323	64,6 x 33,8	24
000031963	70 x 25,4	33
000021590	70 x 32	27
000017942	70 x 36	24
000022320	70 x 37	24
000033966	70 x 41	21
000022322	70 x 42,3	21
000020359	70 x 48	18
000021981	70 x 64,7	12
000019299	97 x 42,3	12
000017943	97 x 67,7	8
000017934	105 x 37	16
000033141	105x42,3	14
000017932	105 x 48	12
000017935	105 x 57	10
000017936	105 x 74	8
000017933	105 x 148	4
000017944	192 x 38	7
000017945	192 x 61	4
000024447	210 x 148,5	2
000017938	210 x 297	1
000024543	Ø20	96
000033543	Ø40	24
000017937	Ø117	2



laser



ink jet



copy



dot matrix



format



sheets



38 x 21,2 mm



48,5 x 25,4 mm

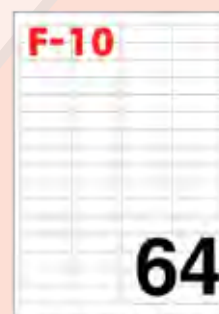

48,5 x 16,9 mm



52,5 x 21,2 mm



52,5 x 29,7 mm



64,6 x 33,8 mm



97 x 42,3 mm



70 x 32 mm

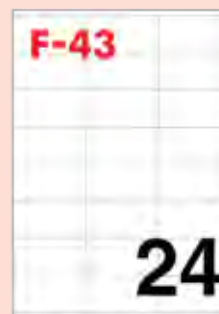

70 x 36 mm



70 x 37 mm

24

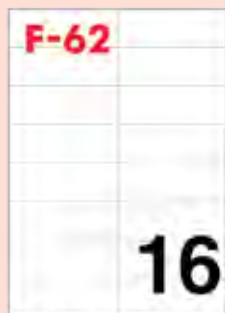

105 x 37 mm

16

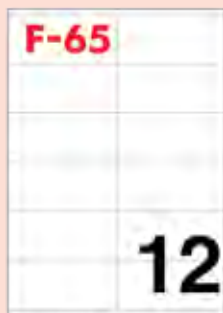

105 x 48 mm

12



105 x 57 mm

10



105 x 74 mm

8



105 x 148 mm

4



210 x 297 mm

1



210 x 148 mm

2



Ø20 mm

96

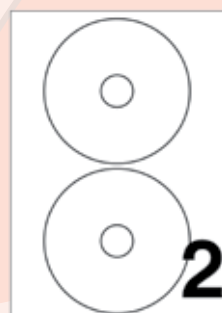

Ø117 mm

2

ODLJEPLJIVE ETIKETE



17,8 x 10 mm

270

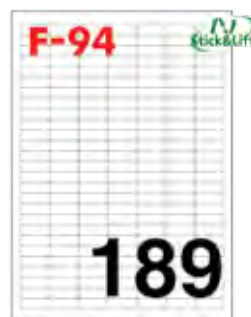

25,4 x 10 mm

189



35,6 x 16,9 mm

80



laser



ink jet



copy



dot matrix



A4

format



100

sheets

fornax

Odljepljive etikete

- za laser, inkjet, color laser i kopirni stroj
- boja bijela
- pakiranje: set od 100 listova formata A4

Šifra	Dimenzije (mm)	Etiketa na listu A4
000023308	17,8 x 10	270
000022321	25,4 x 10	189
000023772	35,6 x 16,9	80
000024493	38 x 21,2	65



38 x 21,2 mm

65

ODSTRANJIVAČ LJEPILA



tesa



VIDJETI NA STR. 198



Etikete

- razne dimenzije i oblici
- pakiranje: set od 10 listova

Šifra	Dimenzije (mm)
00001029	Ø14
000018359	Ø22
000018360	Ø27
000018361	14 x 8
000018362	16 x 10
000018363	19 x 14
000018364	20 x 12
000018365	21 x 8
000018698	22 x 17
000018367	27 x 15
000018368	34 x 5
000018369	34 x 10
000018370	34 x 21
000018371	37 x 19
000018372	37 x 27

Šifra	Dimenzije (mm)
000018373	46 x 8
000018374	46 x 10
000018375	46 x 20
000018376	46 x 27
000018377	46 x 37
000018453	56 x 22
000018378	56 x 34
000018380	58 x 27
000018381	70 x 20
000018382	70 x 56
000018383	73 x 37
000018384	100 x 46
000018385	115 x 70
000018386	142 x 110

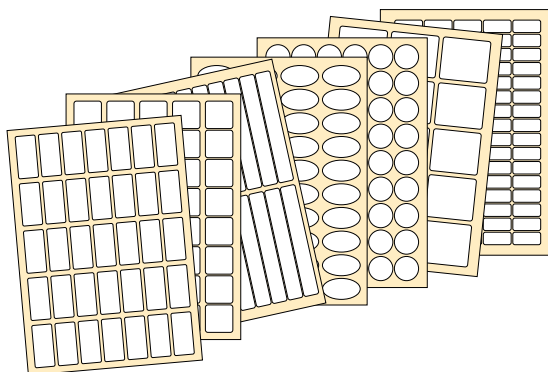

ETIKETE ZA ETIKETIRKE



Etikete za etiketirke Smart

- samoljepljive u roli
- dvoredne
- dimenzija: 26 x 16 mm
- 1000 etiketa na roli
- pakiranje: 36 rola



- 000019900
- 000019904
- 000019901

Etikete za etiketirke Smart

- samoljepljive u roli
- jednorodne, oble
- dimenzija: 26 x 16 mm
- 1000 etiketa na roli
- pakiranje: 36 rola



- 000021987

Etikete odljepljive za etiketirke Smart

- samoljepljive u roli
- jednorodne, oble
- dimenzija: 26 x 16 mm
- 1000 etiketa na roli
- pakiranje: 36 rola



- 000021986

Etikete za etiketirke Smart

- samoljepljive u roli
- jednorodne, oble
- dimenzija: 22 x 12 mm
- 1500 etiketa na roli
- pakiranje: 42 role



- 000019906
- 000019908
- 000019907

Etikete za etiketirke Smart

- samoljepljive u roli
- jednorodne, oble
- dimenzija: 26 x 12 mm
- 1500 etiketa na roli
- pakiranje: 36 role

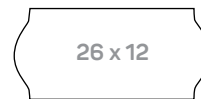

- 000025019



ETIKETIRKE

➔ VIDJETI NA STR. 60

Etikete ukrasne u boji za cijene

- raznih boja i oblika
- fluorescentne boje: narančasta, žuta, roza, zelena, crvena



Šifra	Opis	Pakiranje
000003133	velike	50
000003134	srednje	50
000001058	male	50

BLOKOVI SAMOLJEPLJIVI



3M

Blok samoljepljivi Post-it Canary

- koristi se za zabilješke, poruke...
- idealni za Vaš ured i dom



Šifra	Boja	Dimenzija (mm)
000013985	žuta	38 x 51



tesa

Blok samoljepljivi

- za jednostavnu upotrebu i označavanje
- svijetlo žute boje za lakšu čitljivost
- dobro prijanjanje na podlogu
- lako se otklanja
- ljepilo bez otapala
- dobra kvaliteta papira



Šifra	Boja	Dimenzija (mm)
000019702	žuta	75 x 75
000019701	žuta	125 x 75



Tartan

Blok samoljepljivi

- koristi se za zabilješke, poruke...
- intenzivnih boja
- idealni za Vaš ured i dom
- birate boju bloka koju želite



Šifra	Boje	Dimenzija (mm)
000010821	ružičasta, žuta, zelena	76 x 76

Don't
forget!

BEST
CHOICE

100%
Premium
Quality



TRY
NOW



Click
here



DO WHAT
YOU
LOVE
WHAT DO
YOU DO



BUY
NOW

fornax®

Blok samoljepljivi

- koristi se za zabilješke, poruke...
- idealni za Vaš ured i dom



Šifra	Boja	Dimenzija (mm)
000003723		38 x 51
000003267		76 x 76
000003288		76 x 127



GlobalNotes

**Blok samoljepljivi**

- ljepi se na papiru i raznim površinama
- lako se odljepljuje i ponovno zaljepljuje
- koristi se za poruke...
- 80 % ljepljiva površina
- ljepilo na bazi vode



Šifra	Boja	Dimenzija (mm)
000025429		75 x 75

**fornax****Blok samoljepljivi**

- koristi se za zabilješke, poruke...
- idealni za Vaš ured i dom
- gramatura papira: 72g/m²



Šifra	Boja	Dimenzija (mm)
000025427		40 x 50
000012853		75 x 75
000012852		125 x 75

**fornax****Blok samoljepljivi**

- koristi se za zabilješke, poruke...
- neonske boje
- gramatura papira: 72g/m²



Šifra	Boja	Dimenzija (mm)
000019265		75 x 75
000019262		75 x 75
000019263		75 x 75
000019264		75 x 75

GlobalNotes

Samoljepljivi papir u roli

- sa stalkom
- reže se na potrebnu veličinu
- ljepljiv cijelom površinom



Šifra	Boja	Dimenzija
000020784		60 mm x 10 m

GlobalNotes

Samoljepljivi papir u roli

- reže se na potrebnu veličinu
- ljepljiv cijelom površinom



Šifra	Boja	Dimenzija
000020785		60 mm x 10 m

GlobalNotes**Blok samoljepljivi Organise Your Work!**

- koristi kao podsjetnik
- lijepi se na papiru i raznim površinama
- lako se odljepljuje i ponovno zaljepljuje
- žuta boja s linijama
- ljepilo na bazi vode
- dimenzija: 100mm x 150mm
- šifra: **000025428**

**GlobalNotes****Blok samoljepljivi Organise Your Work!**

- lijepi se na papiru i raznim površinama
- lako se odljepljuje i ponovno zaljepljuje
- ljepilo na bazi vode
- dimenzija: 100x150 mm
- šifra: **000032074**

**GlobalNotes****Blok samoljepljivi Mandala**

- s dijelom za bojanje
- lijepi se na papiru i raznim površinama
- lako se odljepljuje i ponovno zaljepljuje
- dimenzija: 125x75 mm
- 100 listova u kocki
- šifra: **000030533**

**3M****Z-blok samoljepljivi Canary**

- koristi se za zabilješke, poruke...
- dostupan i žutoj i narančastoj boji
- idealni za Vaš ured i dom



DRŽAČI Z-LISTIĆI



VIDJETI NA STR. 239

GlobalNotes

Šifra	Boje	Dimenzija (mm)
000010600		76 x 76



DRŽAČI Z-LISTIĆA

Inovativnost Z listića omogućuje jednostavnije korištenje u predviđenim stalcima. Post-it Z-listići u stalku omogućavaju rad više stvari od jednom, potezom jedne ruke izvučete listić i zapišete poruku. Izvucite jedan listić i drugi je već nadohvat ruke.



GlobalNotes

Z-blok samoljepljivi

- koristi se za zabilješke, poruke...
- s ljepilom na bazi vode



Šifra	Boja	Dimenzija (mm)
000019887		75 x 75

GlobalNotes

Z-blok samoljepljivi Brilliant

- koristi se za zabilješke, poruke...
- s ljepilom na bazi vode



Šifra	Boja	Dimenzija (mm)
000030528		75 x 75

KOCKE SAMOLJEPLJIVE

GlobalNotes

Kocka samoljepljiva

- koristi se za zabilješke, poruke...
- lijepi se na papiru i raznim površinama
- dimenzija: 75x75 mm
- 450 listova u bloku

Šifra	Mix boje	Dimenzija (mm)
000030529		75 x 75
000030530		75 x 75
000033424		75 x 75



fornax

Kocka samoljepljiva

- koristi se za zabilješke, poruke...
- dimenzija: 76x76 mm
- 450 listova u bloku

Šifra	Mix boje	Dimenzija (mm)
000012289		75 x 75
000012287		75 x 75
000012288		75 x 75





GlobalNotes

Kocka samoljepljiva

- koristi se za zabilješke, poruke...
- lijepi se na papiru i raznim površinama
- dimenzija: 75x75 mm
- 400 listova u bloku

Šifra	Mix boje	Dimenzija (mm)
000025430		75 x 75
000025431		75 x 75
000025432		75 x 75
000033423		75 x 75



GlobalNotes

Blok samoljepljivi

- koristi se za zabilješke, poruke...
- lijepi se na papiru i raznim površinama
- raznih oblika
- 200 listova u bloku

Šifra	Opis	Dimenzija (mm)
000033425	jabuka	70 x 70
000033426	oblačić	70 x 70



KOCKE PAPIRNE

Kocka papirna u boji

- koristi se za zabilješke
- mix intenzivnih boja
- dimenzija: 90x90 mm
- 750 listova u bloku
- pakiranje: 1
- šifra: 000000213



fornax

Kocka papirna

- koristi se za zabilješke
- mix pastelnih boja
- dimenzija: 90x90x90 mm
- pakiranje: 16
- šifra: 000027194



fornax**Kocka papirna**

- ljepljena
- koristi se za zabilješke
- mix intenzivnih boja
- dimenzija: 90x90 mm
- pakiranje: 18
- šifra: **000028160**

**fornax****Kocka papirna**

- ljepljena
- koristi se za zabilješke
- bijele boje
- dimenzija: 90x90 mm
- pakiranje: 1
- šifra: **000019298**

**fornax****Kocka papirna**

- ljepljena
- koristi se za zabilješke
- mix boja
- dimenzija: 90x90x90 mm
- pakiranje: 16
- šifra: **000022507**

**fornax****Kocka papirna**

- nije ljepljena
- koristi se za zabilješke
- bijele boje
- dimenzija: 90x90x90 mm
- pakiranje: 16
- šifra: **000022508**

**Kocka papirna Pineapple**

- koristi se za zabilješke
- papir roze boje
- dimenzija papira: 70x70x70 mm
- 600 listova
- pakiranje: 12
- šifra: **000033607**



STALCI ZA PAPIRNE KOCKE

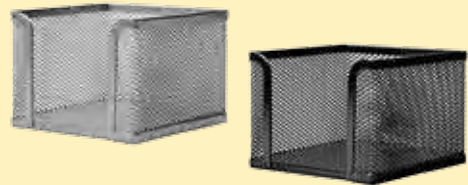

VIDJETI NA STR. 239

fornax**Kocka papirna Elisa**

- nije ljepljena
- koristi se za zabilješke
- sort boje
- dimenzija: 10x8,5x6 mm
- pakiranje: 1
- šifra: **000030062**

**Kocka papirna u PVC kutiji**

- koristi se za zabilješke
- mix 2 boje
- dimenzija: 100x85x60 mm
- pakiranje: 1
- šifra: **000024041**

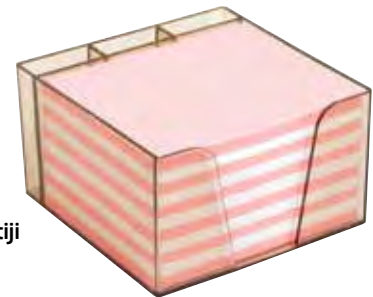
**Kocka papirna u PVC kutiji**

- praktična za svaki ured
- prozirna kutija
- bijeli papir 80g/m2
- dimenzija papirnog bloka: 85x85 mm
- 250 listova u bloku
- pakiranje: 1
- šifra: **000008067**

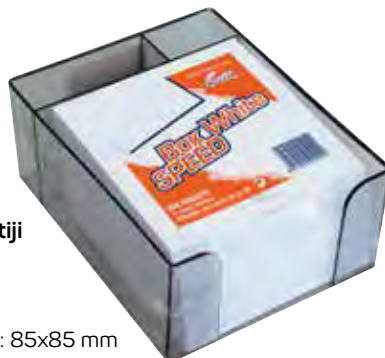
**Kocka papirna u PVC kutiji**

- koristi se za zabilješke
- bijele boje
- dimenzija: 100x85x60 mm
- pakiranje: 1
- šifra: **000023625**



**Kocka papirna u PVC kutiji**

- koristi se za zabilješke
- mix papira intenzivnih boja
- dimenzija papira: 89x89 mm
- pakiranje: 1
- šifra: **000001617**

**Kocka papirna u PVC kutiji**

- koristi se za zabilješke
- papir bijele boje
- dimenzija papira: 85x85 mm
- 900 listova
- pakiranje: 1
- šifra: **000010005**

**3M****Označivač samoljepljivi Post-it**

- mix boja
- pakiranje od 4 boje x 35 zastavica
- dimenzija: 11,9x43,2 mm
- 140 zastavica
- pakiranje: 6
- šifra: **000010508**

**GlobalNotes****Označivač samoljepljivi**

- mix boja
- pakiranje od 4 boje x 36 zastavica
- dimenzija: 12,5x43 mm
- 144 zastavice
- pakiranje: 10
- šifra: **000021579**

**GlobalNotes****Stalak s označivačima**

- uz stalak dolaze zastavice u 4 boje x 36 zastavica
- dimenzija stalka: 90x92 mm
- 144 zastavice
- pakiranje: 48
- šifra: **000033427**

GlobalNotes**Označivač samoljepljivi**

- papirni označivač, mix boja
- lijepi se na razne površine
- ljepilo na bazi vode
- pakiranje od 5 boja x 100 zastavica
- dimenzija: 15x50 mm
- 500 zastavica
- pakiranje: 12
- šifra: **000025433**

**GlobalNotes****Označivač samoljepljivi**

- papirni označivač, mix boja
- lijepi se na razne površine
- ljepilo na bazi vode
- pakiranje od 10 boja x 100 zastavica
- dimenzija: 15x50 mm
- 1000 zastavica
- pakiranje: 10
- šifra: **000033428**





GlobalNotes

Označivač samoljepljivi

- mix boja
- pakiranje od 5 boja x 36 zastavica
- dimenzija: 12.5x43 mm
- 180 zastavica
- pakiranje: 20
- šifra: **000015857**



GlobalNotes

Označivač samoljepljivi

- papirni označivač, mix boja sa simbolima
- pakiranje od 6 boja x 25 zastavica
- dimenzija: 18x55 mm
- 150 zastavica
- pakiranje: 12
- šifra: **000030532**



GlobalNotes

Blokovi post-it i zastavice

- uložni za A4 (univerzalna perforacija)
- dimenzija: 100x270x4 mm
- sadrži: 3 boje x 25 zastavica (25x75 mm), 5 boja x 25 zastavica (12x45 mm, oblik strelice), blok samoljepljiv 2 boje x 25 listova (35x50 mm) i blok samoljepljiv žuti x 25 listova (75x75 mm)
- za označavanje stranica i dokumenata
- pakiranje: 12
- šifra: **000033429**





3M

Označivač samoljepljivi Post-it

- visoko profesionalni, izdržljivi i praktični
- jednostavno se zalijepi i odlijepi
- blister pakiranje
- dimenzija: 25,4x43,2 mm
- 50 zastavica

Šifra	Boja	Dimenzija (mm)	Pakiranje
000010511		25,4 x 43,2	12
000011337		25,4 x 43,2	12
000011335		25,4 x 43,2	12
000010509		25,4 x 43,2	12
000011334		25,4 x 43,2	12
000010510		25,4 x 43,2	12
000011420		25,4 x 43,2	12
000011336		25,4 x 43,2	12



GlobalNotes

Označivač samoljepljivi

- praktičan za svakodnevnu upotrebu
- blister pakiranje
- dimenzija: 25,4x43,2 mm
- 50 zastavica

Šifra	Boja	Dimenzija (mm)	Pakiranje
000015858		25,4 x 43,2	24
000015859		25,4 x 43,2	24
000015862		25,4 x 43,2	24
000015860		25,4 x 43,2	24
000015861		25,4 x 43,2	24

EcoQua

the Notebooks 100% Nature



EcoQua! A 100% environmentally-friendly notebook featuring high-quality 85 g/m² ivory-tinted paper. **EcoQua** is perfect for all kinds of writing, whether you use ballpoint, fountain or marker pens. Approved by Federottica (the Italian National Association of Optometrists and Opticians - cert. n. 654), meeting reading and writing standards. **EcoQua!**

EcoQua uses FSC* certified paper made from cellulose fibres, perfect for recording and preserving written work of great magnitude. The paper comes from forests that are correctly planted and managed and is bleached without using any

chlorine or acids**. **EcoQua!** The cover is scratch-resistant and has a lovely feel, extremely smooth to the touch. It is mass-coloured with light-fast pigments, is non-laminated and thus completely recyclable. **EcoQua!**

100% made in Italy with our papers, EcoQua has a zero carbon footprint. This means zero problems for the environment. It is a feast for the hands and eyes which won't hit you hard in the wallet! EcoQua, the notebook 100% Nature.

FABRIANO®

www.fabriano.com



Planer

- korice metalizirane
- format: A5
- elastična guma
- označivač stranica
- 96 listova, 80g/m² papir
- 3 boje, sortirano
- pakiranje: 5
- šifra: **000030835**



Planer

- korice od čvrstog Balacron materijala
- dostupan u A4, A5 i A6 formatima
- elastična guma
- crna boja
- označivač stranica
- 192 stranice, 80g/m²



Šifra	Format	Pakiranje
000017592	A4	3
000017043	A5	5
000017042	A6	5

FABRIANO

Planer EcoQua

- format A5 i A6
- 160 stranica, 85g/m² papir
- elastična guma
- pakiranje: 5



A5

- **000021611**
- **000021610**
- **000021615**
- **000021609**
- **000021608**
- **000021612**
- **000021614**
- **000021613**

A6

- **000021619**
- **000021618**
- **000021623**
- **000021617**
- **000021616**
- **000021620**
- **000021622**
- **000021621**





ROKOVNICI

U našoj ponudi imamo rokovnike i planere u formatima: A4, A5 i B5, u raznim bojama i materijalima.



**Bilježnice tvrdi uvez**

- kvalitetne jednobojne bilježnice
- korice plastificirane
- 100 listova

Šifra	Opis	Format
000011087	dikto	A4
000011088	karo	A4
000011089	visoki karo	A4
000011085	dikto	A5
000011086	karo	A5

**Bilježnice tvrdi uvez**

- uvez u platno
- format: A4

Šifra	Opis	Listova
000011875	dikto	300
000011874	karo	300
000011876	visoki karo	300
000011878	dikto	200
000011877	karo	200
000011879	visoki karo	200

**Bilježnice tvrdi uvez**

- jednobojne bilježnice s indexom
- korice plastificirane
- opis: dikto
- format: A4 i A5

Šifra	Format	Listova
000000183	A4	200
000000180	A4	100
000000386	A5	100

fornax**Bilježnice spiralni uvez**

- 70 listova, 60 g/m²
- perforirani listovi
- 4 motiva, sortirano
- pakiranje: 40

Šifra	Opis	Format
000018458	dikto	A4
000018459	karo	A4
000020406	dikto	A5
000020405	karo	A5

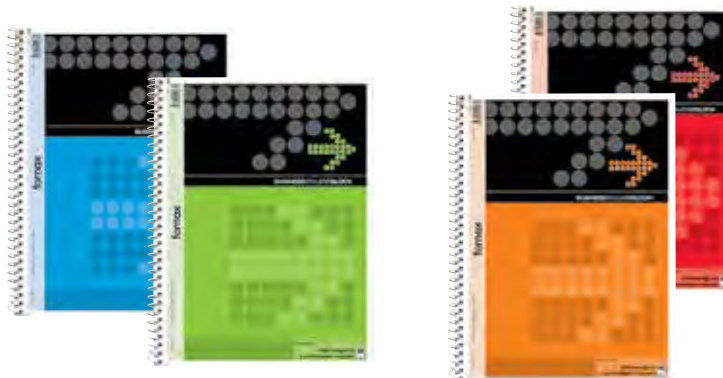
**Bilježnica s pregradama spiralni uvez**

- s 4 pregrade u bojama
- elastična guma
- perforirani listovi
- 120 listova, 80 g/m²
- sort boje

Šifra	Opis	Format
000023577	karo	A4
000023576	dikto	A4



Bilježnica spiralni uvez

- PVC korica u fluorescentnim bojama
- s gumicom
- 80 listova, 80 g/m²
- pakiranje: 5

Šifra	Opis	Format
000015013	karo	A4
000015012	dikto	A4



Bilježnica spiralni uvez Neon

- PP korica u fluorescentnim bojama
- s 4 pregrade
- format: A4, dikto
- 120 listova, 80 g/m²
- sort boje
- pakiranje: 10
- šifra: **000028556**



Bilježnica spiralni uvez Metallic

- korica plave metalik boje
- format: A4, dikto
- 80 listova, 90 g/m²
- pakiranje: 5
- šifra: **000033602**



Bilježnica spiralni uvez Metallic

- korica tamnosive metalik boje
- format: A4, karo
- 80 listova, 90 g/m²
- pakiranje: 5
- šifra: **000033467**



Bilježnica spiralni uvez Metallic

- format: A5
- 80 listova, 90 g/m²
- 4 boje, sortirano
- pakiranje: 5

Šifra	Opis	Format
000017583	karo	A5
000033601	dikto	A5



Bilježnica meki uvez Unitinta

- korice: UV lak
- 40 listova, 80 g/m²
- 9 boja, sortirano
- pakiranje: 10

Šifra	Opis	Format
000030953	karo	A4
000030952	dikto	A4



Connect

Bilježnica meki uvez iStyle

- korice: UV lak i mat plastificirane
- 52 lista
- 80 g/m²
- 16 motiva, sortirano

Šifra	Format/Opis	Pakiranje
000026726	A4/karo	10
000026725	A4/dikto	10
000026727	A4/čista	10
000026729	A5/karo	10
000026728	A5/dikto	10
000026730	A5/čista	10
000026731	A5/latajn	10



Connect

Bilježnica meki uvez

- korice: lak, mat plastificirane
- 40 lista, 80 g/m²
- 9 motiva, sortirano

Šifra	Format/Opis	Pakiranje
000030450	A4/karo	10
000030451	A4/dikto	10
000030449	A5/karo	10
000030448	A5/dikto	10

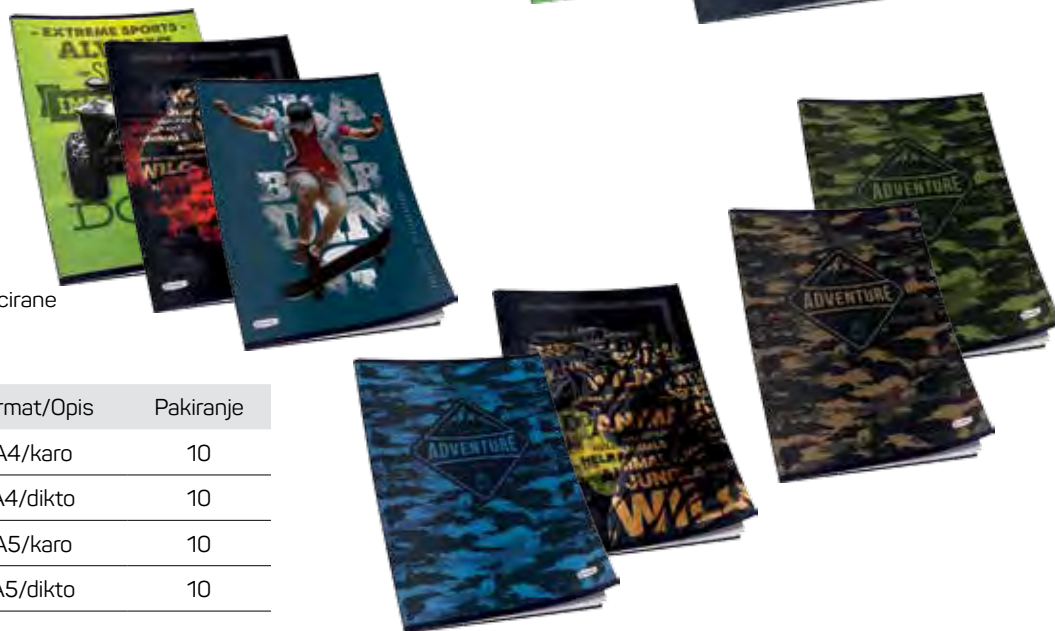

Connect

Bilježnica meki uvez Enjoy Colouring

- korice: neplastificirane i pogodne za bojanje
- 40 listova
- 80 g/m²
- 6 motiva, sortirano

Šifra	Format/Opis	Pakiranje
000028539	A4/karo	10
000028538	A4/dikto	10



**Kajdanka meki uvez**

- format: A5
- 16 listova, 60 g/m²
- pakiranje: 100
- šifra: **00000329**

**Connect****Kajdanka tvrdi uvez**

- format: B5
- 80 listova, 80 g/m²
- 4 motiva, sortirano
- pakiranje: 30
- šifra: **000003117**

**Zadačnica**

- format: A4
- 12 listova
- 60 g/m²

Šifra	Opis	Pakiranje
00006772	karo	25
00000269	dikto	25



Više o bilježnicama i školskim obrascima možete vidjeti u našem Školskom katalogu.

Connect**Blok za crtanje**

- obostrani Akvarel papir za crtanje Fabriano Elle Erre
- za crtanje: grafitnim, pastelnim, tempera i vodenim bojama
- 10 listova

Šifra	Naziv	Pakiranje
000001930	Blok za crtanje 2	100
000001942	Blok za crtanje 3	100
000001931	Blok za crtanje 4	100
000001932	Blok za crtanje 5	100

**Connect****Mapa za likovno**

- 7 vrsta papira i ogleđna mapa za odlaganje radova
- 32 lista

Šifra	Naziv	Pakiranje
00000205	mapa za I, II i III razred	25
00000206	mapa za IV, V i VI razred	25
00000207	mapa za VII i VIII razred	25

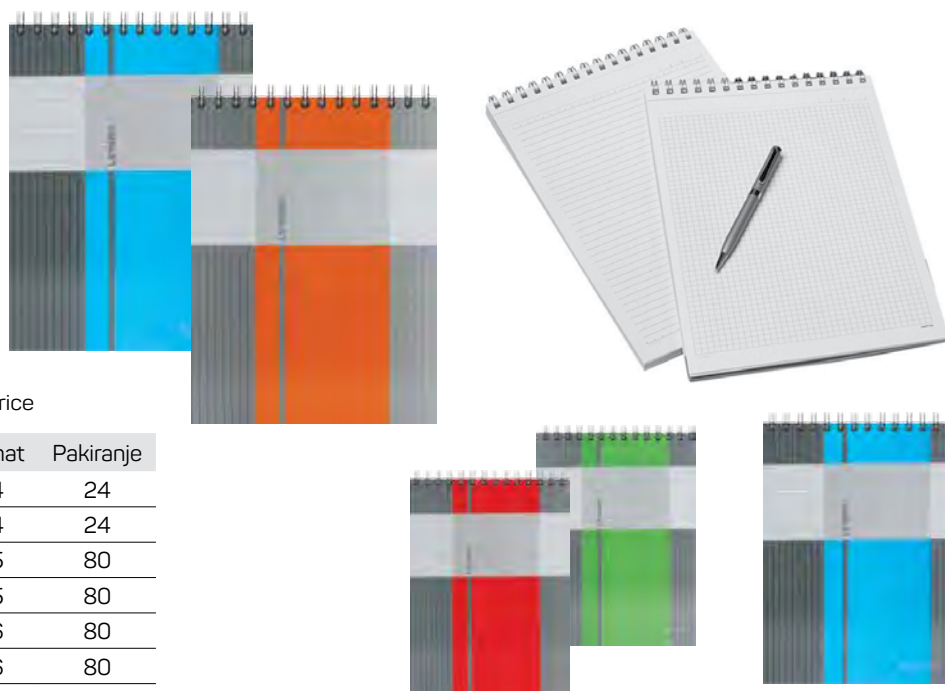

BLOKOVI SPIRALNI

**Blok spirala Linear Marker**

- 80 listova
- 90 g/m²
- mat plastificirane i lakirane korice

Šifra	Opis	Format	Pakiranje
000020750	karo	A4	24
000020751	dikto	A4	24
000020795	karo	A5	80
000020794	dikto	A5	80
000020796	karo	A6	80
000020797	dikto	A6	80

BLOKOVI LAJMANI

**Blok notes Blasetti**

- lajmani blok
- 60 listova
- 50 g/m²

Šifra	Opis	Format	Pakiranje
000020791	karo	A4	10
000020749	dikto	A4	10
000020752	karo	A5	10
000020747	dikto	A5	10
000020793	karo	A6	20

RED in BW®

Blok notes

- lajmani blok
- 60 listova
- format: A7
- opis: karo
- pakiranje: 20
- šifra: 000001432

fornax**Blok notes**

- lajmani blok
- opis: karo
- 50 listova
- 70 g/m²

Šifra	Naziv	Dimenzija (mm)	Pakiranje
000021870	Br. 2	65 x 115	10
000021871	Br. 3	80 x 130	10
000021872	Br. 4	90 x 160	10
000021873	Br. 5	100 x 170	10

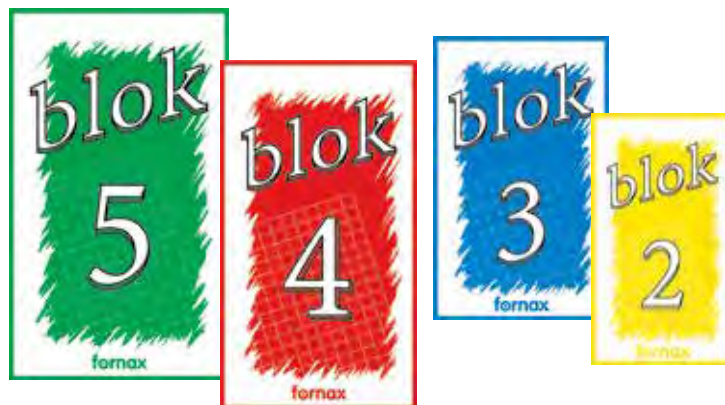

fornax

Blok notes

- bez naslovnice
- 50 listova (70g/m²)

Šifra	Opis	Format	Pakiranje
000027623	dikto	A4	10
000027624	karo	A4	10
000027625	dikto	A5	10
000027626	karo	A5	10
000027627	dikto	A6	10
000027628	karo	A6	10



BLOKOVSKA ROBA



Nalog za službeno putovanje

- format: A5
- pakiranje: 250
- šifra: 000029207



Putni radni list PN-3

- za teretno motorno vozilo
- format: A4
- pakiranje: 16
- šifra: 000000321



Putni radni list PN-4

- za putničko motorno vozilo
- format: A4
- pakiranje: 16
- šifra: 000000313



Popis robe

- format: A4
- pakiranje: 25
- šifra: 000000928



CMR Međunarodni tovarni list

- format: A4
- pakiranje: 400
- šifra: 000000886



Uplatnica bankovna 100/1

- NCR, 1+3
- pakiranje: 24
- šifra: 000005714

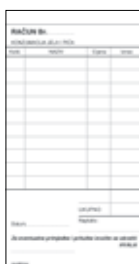

Blok konzumacije

- 50 listova
- pakiranje: 15
- šifra: 000000650

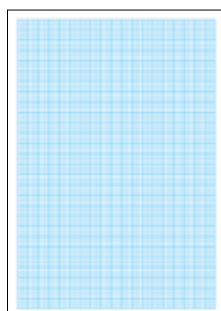

Blok milimetarski

- format: A4
- pakiranje: 10
- šifra: 000001107

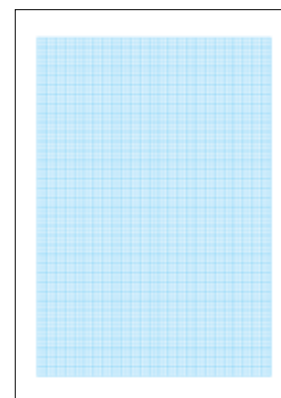

Blok milimetarski

- format: A3
- pakiranje: 10
- šifra: 000000912



GRAFOTISAK

Blagajnički izvještaj

- format: A4
- pakiranje: 25
- šifra: **000000319**



GRAFOTISAK

Izlaz robe

- format: A5
- pakiranje: 50
- šifra: **000000246**



GRAFOTISAK

Obrazac pisani fiskalni račun

- format: A5
- pakiranje: 90

Šifra	Oznaka
000018993	PFR1
000018994	PFR2



GRAFOTISAK

Blagajnički primitak

- format: A5
- pakiranje: 50
- šifra: **000000244**



GRAFOTISAK

Uplatnica

- format: A6
- pakiranje: 100
- šifra: **000000315**



GRAFOTISAK

Ulaz robe

- format: A5
- pakiranje: 50
- šifra: **000000247**



GRAFOTISAK

Obrazac pisani fiskalni reklamni račun

- format: A5
- pakiranje: 90

Šifra	Oznaka
000018995	PRR1
000018996	PRR2



GRAFOTISAK

Blagajnički izdatak

- format: A5
- pakiranje: 50
- šifra: **000000245**



GRAFOTISAK

Isplatnica

- format: A6
- pakiranje: 100
- šifra: **000000316**

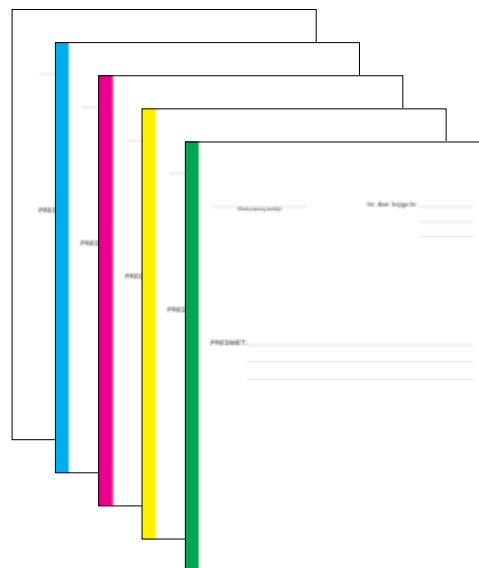

GRAFOTISAK

Omot spisa

- pakiranje: 1000/1

Šifra	Boja
000000924	bijela
000000451	plava
000000450	crvena
000000925	zelena
000000926	žuta



GRAFOTISAK

Račun

Šifra	Format	Opis	Pakiranje
00000250	A4	s PDV-om	25
00011499	A5	bez PDV-a	50
00000249	A5	s PDV-om	50
00000318	A6	s PDV-om	100



GRAFOTISAK

Knjige

Šifra	Naziv	Pakiranje
000030269	Knjiga evidencije o radnom vremenu	40
000030270	Knjiga evidencije o radnicima	18
000013683	Knjiga evidencije potraživanja i obaveza	20
000018935	Knjiga fiskalnih dnevnih izvještaja A4	35
000012155	Dnevnik građevinski tvrdi uvez	13
000034028	Knjiga interna dostavna	10
000012156	Knjiga izdanih računa tvrdi uvez GTG	14
000000224	Knjiga prihoda i rashoda GTG	20
000000030	Knjiga primljene pošte	15
000000285	Knjiga prometa	20
000000024	Knjiga prometa i zaključenje stanja	20
000012239	Knjiga trgovine na malo tvrdi uvez	15
000016884	Knjiga ulaznih računa tvrdi uvez	14
000000748	Knjiga urudžbeni zapisnik UT12	17



GRAFOTISAK

Otpremnica

Šifra	Format	Pakiranje
000000317	A4	25
000000248	A5	50

GRAFOTISAK

Skladišna kartica

- pakiranje: 1000/1

Šifra	Boja
000000910	žuta
000000909	bijela



BLOKOVI NUMERIRANI



Blok numerirani

- lajmani blok
- 100 listova u bloku
- dimenzija: 130 x 60 mm
- pakiranje: 50
- šifra: **000000887**



Blok dvodjelni numerirani

- numeracija + serija s ruba
- za trgovinu i ugostiteljstvo
- 100 listova u bloku
- dimenzija: 144 x 55 mm
- pakiranje: 200
- šifra: **000020401**

Mars® Lumograph® za postizanje efekta sjenčenja







DOBRO JE ZNATI



Kemijska olovka
Kemijska olovka koristi tintu na bazi ulja. Vrh kemijskih olovki je napravljen od aluminija, čelika ili volfram karbida. Tinta se suši jako brzo, te onemogućuje razmazivanje.



Roler
Roler koristi tintu na bazi vode ili gela. Manje viskozna tinta se lakše apsorbira na papir nego tinta na bazi ulja, te omogućuje lakše pisanje po površinama.



Naliv pero
Naliv pero koristi tintu na bazi vode koja prolazi kroz zašiljeni vrh. Pogodno je za lijepo pisanje i potpisivanje posebnih dokumenata.



Tehnička olovka
Tehnička olovka napravljena je od metala ili plastike, u koju se stavlja mina. Promjeri mina su 0,3, 0,5, 0,7, 0,9, 1,3 i 2 mm. Mine mogu biti različitih tvrdoća i boja. Ovisno koju stavite u tehničku olovku. Minu 2 mm koriste šestari.

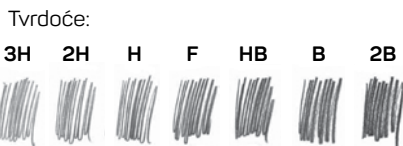

Mine za tehničke olovke
Promjeri mina su 0,3, 0,5, 0,7, 0,9, 1,3 i 2 mm. Mine mogu biti različitih tvrdoća i boja. Ovisno koju stavite u tehničku olovku. Minu 2 mm koriste šestari.



Suha olovka
Suha olovka napravljena je od drveta, kroz koju prolazi grafit. Grafit može biti različitih tvrdoća.

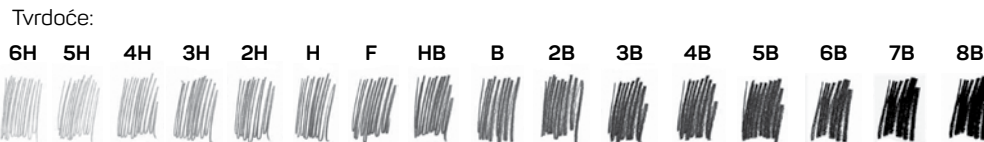

Signir
Služi isključivo za označavanje i naglašavanje, postoje boje signira koje ostaju označene i nakon fotokopiranja.

Markeri



Permanentni
Služi za pisanje po svim površinama, ne može se izbrisati.



Flipchart
Služi za pisanje po flipchart blokovima, s tintom na bazi vode, koja se ne preslikava na drugu stranu papira.



Whiteboard
Služi za pisanje po bijelim pločama, briše se posebnim spužvama.



Odreznani vrh
Mogućnost ispisa u više debljina.



Okrugli vrh
Podjednak ispis.

Širina ispisa



kosi vrh oko 2 ili 5 mm



zaobljen vrh oko 2 mm

Pelikan 

Olovka kemijska K 800

- elegantni dizajn
- srednja debljina ispisa
- pojedini dijelovi su kromirani
- mehanizam na okretanje
- koristi refil: 337 M
- pakiranje: 1
- šifra: **000002081**



Pelikan 

Olovka kemijska K 600

- elegantni dizajn
- pojedini dijelovi su kromirani
- mehanizam na okretanje
- srednja debljina ispisa
- koristi refil: 337 M
- pakiranje: 1
- šifra: **000013398**



Pelikan 

Olovka kemijska K 400

- elegantnog dizajna
- srednja debljina ispisa
- pojedini dijelovi su napravljeni ručnim radom
- mehanizam na potisak
- koristi refil: 337 M
- pakiranje: 1
- šifra: **000002075**



REFILI ZA KEMIJSKE OLOVKE I ROLERE

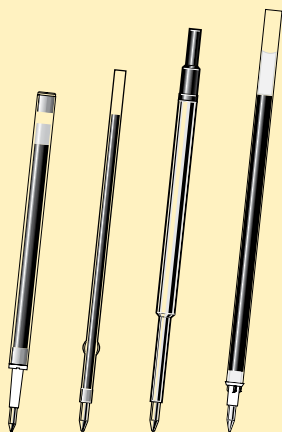

VIDJETI NA STR. 128

Pelikan 

Olovka kemijska K 200

- srednja debljina ispisa
- mehanizam na potisak
- koristi refil: 337 M
- pakiranje: 1
- šifra: **000009629**



Pelikan 

Olovka kemijska K 215

- elegantnog dizajna
- srednja debljina ispisa
- pojedini dijelovi su kromirani
- pritisni mehanizam
- koristi refil: 337 M
- pakiranje: 1
- šifra: **000014915**



Pelikan 

Olovka kemijska K 150

- srednja debljina ispisa
- mehanizam na potisak
- koristi refil: 337 M
- pakiranje: 1
- šifra: **000002985**



Pelikan 

Olovka kemijska K 40



- srednja debljina ispisa
- mehanizam na potisak
- pakiranje: 1
- šifra: **000013977**



Pelikan 

Olovka kemijska K 40 Pura

- srednja debljina ispisa
- mehanizam na potisak
- pakiranje: 1

-  • **000032510**
-  • **000032511**





Pisane Cardin

Olovka kemijska Christophe

- vrh 0.5 mm s plavim refilom
- pakiranje: 1
- šifra: **000030413**



Pisane Cardin

Olovka kemijska Laurence

- s rotacijskim mehanizmom
- vrh 0.5 mm s plavim refilom
- pakiranje: 1
- šifra: **000030411**



Pisane Cardin

Olovka kemijska Didier

- s rotacijskim mehanizmom
- vrh 0.5 mm s plavim refilom
- pakiranje: 1
- šifra: **000030410**



Pisane Cardin

Olovka kemijska Espace

- s rotacijskim mehanizmom
- vrh 0.5 mm s plavim refilom
- pakiranje: 1

- **000030403**
- **000030405**
- **000030404**



Pisane Cardin

Olovka kemijska Renee

- s rotacijskim mehanizmom
- pakiranje: 1

- **000030406**
- **000030407**



Pisane Cardin

Olovka kemijska Olivier

- s rotacijskim mehanizmom
- vrh 0.5 mm s plavim refilom
- pakiranje: 1
- šifra: **000030408**



Pisane Cardin

Olovka kemijska Aurelie

- s rotacijskim mehanizmom
- vrh 0.5 mm s plavim refilom
- pakiranje: 1
- šifra: **000030409**



Pisane Cardin

Olovka kemijska Adeline

- s funkcijom touch pen
- rotirajući mehanizam
- pakiranje: 1
- šifra: **000030416**





Set pisači

- olovka kemijska i tehnička olovka
- elegantni dizajn, ergonomski oblik s presvučenim gripom
- vrh kemijske olovke je 1.0 mm, a tehničke olovke je 0.7 mm
- dostupan u 4 boje stabla
- pakiranje: 1

- Boje stabla:
- 000016480
 - 000014301
 - 000014294
 - 000014300



Olovka kemijska Jotter

- PVC stablo u boji sa sjajnim kromiranim gornjim dijelom
- boja ispisa je plava
- debljina ispisa: F i M
- pakiranje: 1

- 000018350
- 000000104
- 000023284
- 000018352



Olovka kemijska X-Beam

- s gumiranim stablom u boji tinte
- vrh uloška je od nehrđajućeg čelika
- dostupna u 3 boje
- koristi refil BRM98C07
- pakiranje: 12

- 000033674
- 000033675
- 000033673



Olovka kemijska Rexgrip Begreen

- atraktivnog i modernog dizajna
- tinta na bazi ulja
- izrađena od 77,7 % recikliranih materijala
- dostupna u 3 boje
- koristi refil RFJS-GP-F
- pakiranje: 10

- 000018402
- 000010353
- 000018401



Olovka kemijska RB-085 B

- s gumiranim stablom u boji tinte
- vrh uloška je od nehrđajućeg čelika
- dostupna u 3 boje
- koristi refil BR98C07
- pakiranje: 12

- 000012449
- 000012450
- 000012451



penac
JAPAN

Olovka kemijska RBR

- s gumiranim stablom u boji tinte
- vrh uloška je od nehrđajućeg čelika
- dostupna u 3 boje
- koristi refil BR98C07
- pakiranje: 12

- 000012446
- 000012447
- 000012448



uni-ball

Olovka kemijska SD-102

- s PVC stablom
- kuglica promjera 0.7 mm
- dostupna u 3 boje: crna, crvena i plava
- koristi refil S-7L
- pakiranje: 12

- 000018419
- 000002869
- 000018418



penac
JAPAN

Olovka kemijska CCH-3

- s gumenim gripom
- vrh uloška je od nehrđajućeg čelika
- PVC stablo, prozirno, grip u boji tinte
- dostupna u 3 boje
- koristi refil BR98C07
- pakiranje: 12

- 000012457
- 000012455
- 000012456



penac
JAPAN

Olovka kemijska Sleek Touch

- s gumenim gripom
- vrh uloška je od nehrđajućeg čelika
- PVC stablo, prozirno, grip u boji tinte
- dostupna u 3 boje
- koristi refil BR98C07
- pakiranje: 12

- 000013769
- 000013768
- 000013770



Olovka kemijska Super Grip

- jednostavnog dizajna s gumenim gripom
- tinta na bazi ulja, vodootporna
- dostupna u 3 boje
- koristi refil RFJS-GP-F
- pakiranje: 12

- 000016477
- 000000691
- 000016476



fornax

Olovka kemijska Grip F-070

- s gumenim gripom
- PVC stablo
- dostupna u 3 boje
- pakiranje: 12

- 000026327
- 000026326
- 000026328



uni-ball

Olovka kemijska Laknock SN-101

- vrh od nehrđajućeg čelika, PVC stablo
- s gumiranim gripom
- kuglica promjera 0.7 mm
- koristi refil SA-7C
- dostupna u 3 boje
- pakiranje: 12

- 000018423
- 000002866
- 000018422



Connect

Olovka kemijska Grip F-070

- s gumenim gripom
- PVC stablo
- boja ispisa plava
- dostupna u 4 boje
- pakiranje: 12

- 000029625
- 000029622
- 000029623
- 000029624



uni-ball

Olovka kemijska SD-108

- na patent
- držač olovke je gumiran i u boji tinte
- kuglica promjera 0.7 mm
- dostupna u 3 boje
- koristi refil SA-7C
- pakiranje: 12

- 000018397
- 000005449
- 000018398



Olovka kemijska BPS-MATIC 135

- PVC stablo, prozirno s podlogom boje refila koji koristi
- dostupna u 3 boje
- koristi refil RFJS/BSRF6
- pakiranje: 12

- 000016475
- 000000131
- 000016474



PIERANTONI

Olovka kemijska Mr. Pen S-335

- s gumenim gripom
- PVC stablo, prozirno, grip u boji tinte
- dostupna u 3 boje
- koristi refil CHR 11
- pakiranje: 12

- 000018130
- 000018129
- 000018131



PIERANTONI

Olovka kemijska Mr. Pen L-5

- s gumenim gripom
- PVC stablo, prozirno, grip u boji tinte
- dostupna u 3 boje
- koristi refil CHR 11 09
- pakiranje: 12

- 000018133
- 000018132
- 000018134





Olovka kemijska L-5 Color

- s gumenim gripom
- PVC stablo
- 4 boje: sortirano
- boja ispisa: plava
- pakiranje: 12
- šifra: **000026236**



SCHNEIDER

Olovka kemijska K-15

- praktična kemijska olovka
- PVC stablo u 5 boja
- boja ispisa je plava
- pakiranje: 50

- **000014212**
- **000018146**
- **000014211**
- **000014355**
- **000016220**



Olovka kemijska BPS-GP F

- kemijska olovka u sticku
- s gumenim gripom
- dostupna u 2 boje
- koristi refil RFJ/BPRFG
- pakiranje: 12

- **000014988**
- **000014989**



Olovka kemijska Soft Glider

- s gumenim gripom
- vrh uloška je od nehrđajućeg čelika
- PVC stablo, prozirno
- plave boje
- koristi refil BR14007
- pakiranje: 12
- šifra: **000014324**



Olovka kemijska Stick 430 M

- s poklopcem i kopčom
- dostupna u 2 boje
- pakiranje: 10

- **000009919**
- **000009920**



Olovka kemijska 432

- s poklopcem i kopčom
- PVC stablo, prozirno
- ergonomski trokutasti oblik
- dostupna u 2 boje
- ispis: 0.3 mm
- pakiranje: 10

- **000031255**
- **000031256**



Olovka kemijska Stick 430 F

- s poklopcem i kopčom
- dostupna u 3 boje
- pakiranje: 10

- **000009915**
- **000009916**
- **000009917**



uni-ball

Olovka kemijska SA-S F

- vrh od nehrđajućeg čelika, PVC stablo
- kuglica promjera 0.7 mm
- dostupna u 3 boje
- koristi refil SA-7
- pakiranje: 12

- 000018421
- 000002868
- 000018420



Olovka kemijska X-943

- PVC stablo i čep
- stablo transparentno, a čep u boji tinte
- dostupna u 3 boje
- pakiranje: 30

- 000012250
- 000012720
- 000012249



OLOVKE KEMIJSKE NA STALKU

lebez

Olovka kemijska na stalku

- prigodna za urede, recepcije, banke...
- crne boje sa zlatnim linijama
- okrugli mramorni stalak
- ispis crne boje
- promjer kuglice 0.7 mm
- pakiranje: 1
- šifra: **000000884**



Olovka kemijska na stalku

- prigodna za urede, recepcije, banke...
- bijele boje sa srebrenim linijama
- okrugli PVC stalak
- ispis crne boje
- promjer kuglice 1 mm
- pakiranje: 1
- šifra: **000018943**



lebez

Olovka kemijska na stalku

- prigodna za urede, recepcije, banke...
- crne boje sa zlatnim linijama
- stalak u obliku kugle
- ispis crne boje
- promjer kuglice 0.7 mm
- pakiranje: 1
- šifra: **000000879**





Olovka kemijska na stalku T-Pen

- prigodna za urede, recepcije, banke..
- izrađena od 30 % recikliranog materijala
- okrugli PVC stalak
- mogućnost dotiska
- ispis plave boje
- promjer kuglice 0.7 mm
- pakiranje: 1

- 000023434
- 000023435
- 000023436
- 000023437



Olovka kemijska na stalku Partner Pen

- prigodna za urede, recepcije, banke..
- izrađena od 50 % reciklirane plastike
- okrugli PVC stalak
- mogućnost dotiska
- ispis plave boje
- promjer kuglice 0.7 mm
- pakiranje: 1

- 000023438
- 000023439
- 000023440
- 000023441



ROLERI



Roler CCH-3 07

- s vidljivim spremnikom za tintu
- gumirani grip
- tinta na bazi gela
- ispis plave boje
- koristi refil DB108
- pakiranje: 12
- šifra: **000014341**



Roler CCH-3 05

- s vidljivim spremnikom za tintu
- gumirani grip
- tinta na bazi gela
- koristi refil DB108
- pakiranje: 12

- 000020515
- 000020516
- 000020514



**penac**
JAPAN**Roler Inketti**

- tinta na bazi gela
- brzo se suši
- vrh 0,5 mm
- gumirani grip
- koristi refil GBR305BG
- pakiranje: 12

- 000030969
- 000030967
- 000030968

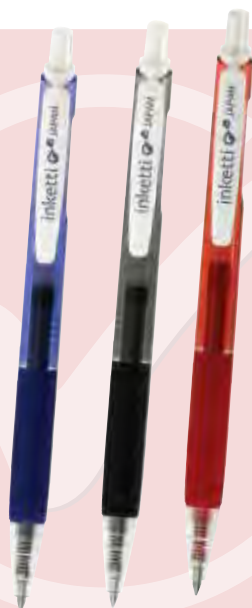
**Roler G-2 07**

- kuglice od volfram karbida
- tinta na bazi gela
- vidljiv spremnik s tintom
- gumirani grip
- koristi refil BLS-G2-07
- pakiranje: 12

- 000016485
- 000002157
- 000016484

**Roler G-2 05**

- kuglice od volfram karbida
- tinta na bazi gela
- vidljiv spremnik s tintom
- gumirani grip
- koristi refil BLS-G2-05
- pakiranje: 12

- 000016479
- 000016487
- 000016478

**penac**
JAPAN**Roler FX-7**

- tinta na bazi gela
- vrh od nehrđajućeg čelika
- plastična s gumenim gripom
- spremnik za tintu vidljiv
- rezervni refil: GBR305 i GBR307
- pakiranje: 12
- šifra: 000012462

**uni-ball****Roler SXN-157S**

- dostupan u 3 boje
- vodootporan, brzo se suši što onemogućuje razmazivanje
- idealan i za ljevake
- koristi refil SXR-7
- pakiranje: 12

- 000011938
- 000011936
- 000011937

**uni-ball****Roller UMN-152 Signo**

- PVC stablo
- gumirani grip u boji tinte
- koristi refil UMR-85
- pakiranje: 12

- 000018440
- 000002865
- 000018439



**Roler Mr. Pen SG**

- s gumenim gripom
- PVC stablo, prozirno, grip u boji tinte
- dostupna u 3 boje

- 000018136
- 000018135
- 000018137

**Roler Friction**

- roler s nepotrošivom silikonskom gumicom na vrhu
- može se pisati i brisati
- dostupna u 3 boje
- koristi refil BL-FR7
- pakiranje: 12

- 000011733
- 000011333
- 000014125

**uni-ball****Roler UB-150**

- debljina ispisa: 0.3 mm
- vrh od nehrđajućeg čelika
- plastično kućište
- čep, vrh čepa i dio kućišta su u boji tinte
- pigmentna voodootporna tinta
- koristi refil UB-150LK
- pakiranje: 12

- 000018435
- 000002852
- 000018434

**uni-ball****Roler UB-157**

- debljina ispisa: 0.5 mm
- vrh od nehrđajućeg čelika
- plastično kućište
- ispis crne boje
- pigmentna voodootporna tinta
- koristi refil UB-157LK
- pakiranje: 12
- šifra: 000022044

**uni-ball****Roller UM-151**

- vrh uloška od nehrđajućeg čelika, s gumenim gripom, plastično kućište
- pigmentna voodootporna tinta na bazi gela
- koristi refil UMR-1
- pakiranje: 12

- 000018438
- 000002864
- 000018437

**Roler V-Ball Grip**

- jedinstvena tinta
- koristi V-sustav, koji omogućuje ugodno prijanjanje i pisanje
- pakiranje: 12

- 000014936
- 000014934

**Roler Crystaljelly E-2185 Metallic**

- gumirani grip
- tinta na bazi gela
- komplet od 7 metalik boja
- pakiranje: 10
- šifra: 000032621





Roler Crystaljelly E-2185

- gumirani grip
- tinta na bazi gela
- pakiranje: 10

- 000022573
- 000022574
- 000022572
- 000032606
- 000032607
- 000032605
- 5/1 • 000027191
- 7/1 • 000032622



Roler G-3

- kuglice od volfram karbida
- tinta na bazi gela
- vidljiv spremnik sa tintom
- gumirani grip
- koristi refil BLS-G1-7
- pakiranje: 12
- šifra: 000007268



uni-ball

Roler UM-101 ER

- s ugrađenom gumicom
- koristi posebnu gel tintu koja se brzo suši
- novi mehanizam s lopticom smanjuje mogućnost curenja
- ispis plave boje
- koristi refil UMR-5ER
- pakiranje: 10
- šifra: 000011173



Roler G-TEC-C4

- za precizno pisanje
- s vidljivim spremnikom za tintu
- pakiranje: 12
- šifra: 000002718

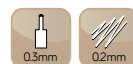

Roler E-85

- tinta na bazi vode
- poklopac u boji tinte
- debljina ispisa 0.3mm
- pakiranje: 10

- 000022646
- 000022647
- 000022645



Roler E-2190

- gumirani grip
- tinta na bazi gela
- pakiranje: 10

- 000032654
- 000032653
- 000032652
- 000032655



Pelikan**Naliv pero M 1000**

- kvalitetno naliv pero
- izrađeno od 24 karatnog zlata
- vrh mu je izrađen ručnim radom, te pozlaćen
- ispis ovisi o tinti koju koristite
- pakiranje: naliv pero u kutiji
- šifra: **000010130**

**Pelikan****Naliv pero M 900 Toledo**

- visokokvalitetno naliv pero
- izrađeno od 24 karatnog zlata, ručni rad
- vrh mu je također izrađen ručnim radom, te pozlaćen
- ispis ovisi o tinti koju koristite
- pakiranje: naliv pero u kutiji
- šifra: **000010910**

**Pelikan****Naliv pero M 700 Toledo**

- kvalitetno naliv pero
- izrađeno od 24 karatnog zlata, ručni rad
- vrh mu je također izrađen ručnim radom, te pozlaćen
- ispis ovisi o tinti koju koristite
- pakiranje: naliv pero u kutiji
- šifra: **000010993**

**Pelikan****Naliv pero M 805**

- s tintom u poklon kutiji
- boje stabla: crna
- vrh i dijelovi u boji srebra
- ispis ovisi o tinti koju koristite
- pakiranje: naliv pero u kutiji
- šifra: **000032587**

**Pelikan****Naliv pero M 800**

- dostupno u tri boje stabla: crna, zelena i plava
- vrh i dijelovi u boji zlata
- ispis ovisi o tinti koju koristite
- pakiranje: naliv pero u kutiji
- šifra: **000010907**

**Pelikan****Naliv pero M 600**

- vrh i dijelovi u boji zlata
- ispis ovisi o tinti koju koristite
- pakiranje: naliv pero u kutiji
- šifra: **000005334**

**Pelikan****Naliv pero M 400**

- vrh i dijelovi u boji zlata
- ispis ovisi o tinti koju koristite
- pakiranje: naliv pero u kutiji
- šifra: **000001703**

**Pelikan****Naliv pero M 200**

- vrh i dijelovi u boji zlata
- ispis ovisi o tinti koju koristite
- pakiranje: naliv pero u kutiji
- šifra: **000032585**

**Pelikan****Naliv pero M 200**

- vrh i dijelovi u boji zlata
- ispis ovisi o tinti koju koristite
- pakiranje: naliv pero u kutiji
- šifra: **000000066**



Pelikan **Naliv pero M 150**

- vrh i dijelovi u boji zlata
- ispis ovisi o tinti koju koristite
- pakiranje: naliv pero u kutiji
- šifra: **000001583**

**Pelikan** **Naliv pero M 150**

- s tintom u poklon kutiji
- vrh i dijelovi u boji zlata
- ispis ovisi o tinti koju koristite
- pakiranje: 1
- šifra: **000001713**

**Pelikan** **Naliv pero M 215**

- vrh i dijelovi u boji srebra
- ispis ovisi o tinti koju koristite
- pakiranje: naliv pero u kutiji
- šifra: **000014914**

**Pelikan** **Naliv pero M 205 Taupe classic**

- vrh i dijelovi u boji srebra
- ispis ovisi o tinti koju koristite
- pakiranje: naliv pero u kutiji
- šifra: **000020293**

**Pelikan** **Naliv pero P40**

- vrh i dijelovi u boji srebra
- ispis ovisi o tinti koju koristite
- pakiranje: 1
- šifra: **000014919**

**Pelikan** **Naliv pero P40 Pura**

- vrh i dijelovi u boji srebra
- ispis ovisi o tinti koju koristite
- pakiranje: 1
- šifra: **000013979**



Više u našem
Promo katalogu.

Naliv pero VPen Fusto

- naliv pero s izbrisivom tintom
- omogućuje glatko pisanje
- pakiranje: 12
- šifra: **000015244**



penac
JAPAN

inketti  JAPAN



BOJA OLOVKE = BOJA TINTE



OLOVKA S NOVOM GEL
TINTOM KOJU ODLIKUJE
DUGOTRAJNOST PISANJA

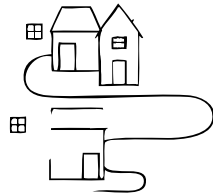

TINTA SE BRZO SUŠI -
U MILISEKUNDAMA!

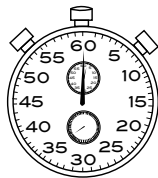

POGODNA ZA
LJEVORUKE

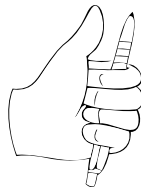



Patrone 480

- za naliv pera
- plave i crne boje
- pakiranje: 6/1



- 000012606
- 000022002



Pelikan

Patrone

- za naliv pera
- plava boja
- pakiranje: 6/1
- šifra: 000025385



Pelikan

Patrone

- za naliv pera
- crvena boja
- pakiranje: 6/1
- šifra: 000025538



Pelikan

Patrone

- za naliv pera
- s dokumental tintom
- crna/plava boja
- pakiranje: 6/1
- šifra: 000025537



Patrone Viva

- za naliv pera
- plava boja
- pakiranje: 6/1
- šifra: 000026213



PARKER

Patrone

- za naliv pera
- plava boja
- pakiranje: 5/1
- šifra: 00001051



Patrone

- za naliv pera
- plava boja
- pakiranje: 5/1
- šifra: 000028991

Pelikan

Pumpica za naliv pera

- pakiranje: 5
- šifra: 000023580



PARKER

Pumpica za naliv pera

- pakiranje: 10
- šifra: 000014815



Pelikan

Tinta za naliv pera

- 30 ml
- pakiranje: 6

- 000023221
- 000019183
- 000000192
- 000019182



**Brisač tinte E-1515**

- s jedne strane flomaster, a s druge brisač tinte
- debljina brisača tinte: 0.8 mm
- debljina ispisa: 0.3 mm
- pakiranje: 48
- šifra: 000022643

**Brisač tinte FOE**

- s jedne strane flomaster, a s druge brisač tinte
- 4 sortirana motiva
- pakiranje: 50
- šifra: 000019384



REFILI ZA KEMIJSKE OLOVKE

Refil RFJS-GP-F

- za Super Grip
- pakiranje: 12

- 000018411
- 000003131
- 000018410

**Refil D1BR6707**

- za Ele
- pakiranje: 12

- 000013289
- 000013288

**Refil BR14007**

- za Soft Glider
- pakiranje: 12

- 000012460

**Refil MJBR107**

- za Fifth Avenue
- pakiranje: 12

- 000013286

**uni-ball****Refil SA-7**

- za SD-102, MSE 500BS
- pakiranje: 20

- 000018395
- 000003294
- 000018396

**Refil PPBR9807**

- za Trifit Penac i Parker kemijske olovke
- pakiranje: 12

- 000013287

**uni-ball****Refil S-7L**

- za MSE-800
- pakiranje: 10

- 000018393
- 000003293
- 000018394

**uni-ball****Refil S-7S**

- za SE3-304
- pakiranje: 10

- 000018389
- 000005732
- 000018390

**uni-ball****Refil SA-7CN**

- za SN-100, SN-101
- pakiranje: 10

- 000018392
- 000003292
- 000018391

**Refil F**

- za Trifit i CCH-3
- pakiranje: 12

- 000012459



Refil BLS-G2-5

- za G-2
- pakiranje: 10

- 000018404
- 000007005
- 000018403

**Refil BLS-FR7-L-S3**

- za Frixion
- pakiranje: 3

- 000016910

**Refil BLS-G2-7**

- za G-2
- pakiranje: 10

- 000018405
- 000018407
- 000018406

**penac**
JAPAN**Refil GBR305-03**

- za CCH-3
- pakiranje: 12

- 000020519
- 000020517

**uni-ball****Refil UMR-7**

- za UM-100
- pakiranje: 12

- 000018413
- 000002891
- 000018412

**uni-ball****Refil UMR-85**

- za UMN-207, UMN-152/105
- pakiranje: 10

- 000002890

**uni-ball****Refil UMR-1**

- za UM-151
- pakiranje: 1

- 000002889

**uni-ball****Refil UMR-5**

- za UM-100
- pakiranje: 1

- 000006030



KOREKTURNI LAK

**Henkel****Korektor Pritt**

- korektor s četkicom
- brzo se suši
- bez otapala
- količina: 20 ml
- pakiranje: 10
- šifra: 000028561

UHU**Korektor**

- korektor s četkicom
- odlično prekrivanje
- brzo se suši
- količina: 20 ml
- pakiranje: 10
- šifra: 000015333

**fornax****Korektor**

- korektor s četkicom
- brzo se suši
- količina: 20 ml
- pakiranje: 10
- šifra: 000012280

**FILA****Korektor**

- korektor s četkicom
- brzo se suši
- količina: 20 ml
- pakiranje: 12
- šifra: 000014739

**Razrijeđivač Edigs**

- za korektorni lak
- količina: 20 ml
- pakiranje: 12
- šifra: 000000453



UHU**Korekturna olovka**

- pogodna za precizno brisanje
- iznimno tanki vrh kuglice
- količina: 7 ml
- pakiranje: 12
- šifra: **000006892**

**uni-ball****Korekturna olovka**

- pogodna za precizno brisanje
- vrh kuglice 1 mm
- metalni vrh sprječava začepljenje
- količina: 8 ml
- pakiranje: 12
- šifra: **000000734**

**edding****Korekturna olovka E-7700**

- idealna za precizno brisanje kemijske olovke i isprintanog teksta
- vrh kuglice od 1 do 2 mm
- brzo se suši
- količina: 8 ml
- pakiranje: 10
- šifra: **000022569**

**siam****Korekturna olovka**

- pogodna za precizno brisanje
- iznimno tanki vrh kuglice
- količina: 7 ml
- pakiranje: 12
- šifra: **000006793**

**foroffice****Korekturna olovka**

- pogodna za precizno brisanje
- metalni vrh kuglice
- količina: 7 ml
- pakiranje: 24
- šifra: **000023015**

**RED-BLU****Korekturna olovka**

- pogodna za precizno brisanje
- iznimno tanki vrh kuglice
- količina: 7 ml
- pakiranje: 12
- šifra: **000024241**



KOREKTURNI ROLERI

Henkel**Korekturni roler Pritt Compact**

- ergonomski grip
- dobro prekrivanje i ljepljenje
- širina trake: 4.2 mm
- dužina trake: 8.5 m
- blister pakiranje: 10
- šifra: **000028563**

**Henkel****Korekturni roler Pritt mini**

- dobro prekrivanje i ljepljenje
- širina trake: 4.2 mm
- dužina trake: 6 m
- blister pakiranje: 10
- šifra: **000028566**

**Henkel****Korekturni roler Pritt Midway**

- ergonomski grip
- mogućnost izmjene refila
- dobro prekrivanje i ljepljenje
- širina trake: 4.2 mm
- dužina trake: 14 m
- blister pakiranje: 1
- šifra: **000028568**

**Henkel****Refil Pritt Midway**

- za korekturni roler Midway
- dobro prekrivanje i ljepljenje
- širina trake: 4.2 mm
- dužina trake: 14 m
- blister pakiranje: 10
- šifra: **000028569**





tesa

Korekturni roler

- kućište od 100 % reciklirane plastike
- sa zaštitnim poklopcem
- ergonomski dizajn
- osnova otporna na pucanje
- automatsko zatezanje trake
- sort boje
- širina trake: 5 mm
- dužina trake: 6 m
- pakiranje: 16
- šifra: **000021153**



PAPER&MATE

Korekturni roler Dry Line

- korektor u traci
- za precizne ispravke
- širina trake: 5 mm
- dužina trake: 8.5 m
- pakiranje: 12
- šifra: **000001792**

FILA

Korekturni roler

- korektor u traci
- za precizne ispravke
- dobro prekrivanje i ljepljenje
- širina trake: 4.2 mm
- dužina trake: 8 m
- pakiranje: 12
- šifra: **000014779**



penac
JAPAN

Korekturni roler White bird

- korektor u traci
- za precizne ispravke
- sort boje
- širina trake: 5 mm
- dužina trake: 8 m
- pakiranje: 24
- šifra: **000016067**



Henkel

Korekturni roler Pritt Comfort Eco

- bočni korektor u traci
- ergonomski grip
- napravljen od 89% obnovljivih materijala
- širina trake: 4.2 mm
- dužina trake: 8.5 m
- blister pakiranje: 20
- šifra: **000028567**



tesa

Korekturni roler

- prvi korekturni roler s bočnim nanošenjem, koji omogućava ispravljanje kako dešnjacima tako i ljevacima
- ergonomski dizajn
- osnova otporna na puca
- automatsko zatezanje trake
- širina trake: 4.2 mm
- dužina trake: 10 m
- blister pakiranje: 5
- šifra: **000012509**



foroffice

Korekturni roler

- korektor u traci
- za precizne ispravke
- širina trake: 5 mm
- dužina trake: 8 m
- pakiranje: 1
- šifra: **000016464**

Henkel

Korekturni roler Pritt

- ergonomski grip
- s klipsom
- ne ostavlja vidljive tragove prilikom fotokopiranja
- širina trake: 5 mm
- dužina trake: 6 m
- blister pakiranje: 10
- šifra: **000028564**



uni-ball

Korektor u traci

- jednostavan za držanje
- sadrži čep da možete zatvoriti korektor i da se ne šteti traka
- debljina trake je 30 % tanja od prethodnog
- sort boje
- širina trake: 5 mm
- dužina trake: 8 m
- debljina trake: 26 µm
- blister pakiranje: 1
- šifra: **000006736**



OLOVKE TEHNIČKE



Olovka tehnička Mars micro 775

- metalna kopča i vrh
- s gumicom
- PVC stablo s gumiranim gripom
- pakiranje: 10

- 0.3 • **000000257**
- 0.5 • **000008673**
- 0.7 • **000001186**
- 0.9 • **000000583**



penac
JAPAN

Olovka tehnička TLG

- ergonomski oblikovan gumeni grip s gumicom
- metalni vrh i klipsa
- pakiranje: 12

- 0.3 • **000029030**
- 0.5 • **000030954**
- 0.7 • **000030955**





Olovka tehnička graphite 779

- ergonomski oblikovana, s gumenim gripom
- PVC stablo s gumicom
- mina s oprugom za izuzetnu otpornost na lomljenje
- ispis 0.5 mm
- pakiranje: 10



- 000013584
- 000013583
- 000013585



Olovka tehnička Graphite 777

- gumirano mat prozirno stablo
- velika gumica u boji stabla
- ispis: 0.5 i 0.7 mm
- pakiranje: 10



- 000013586
- 000008674
- 000013587



- 000000609



Olovka tehnička Protti PRC

- PVC stablo s metalnom klipsom i vrhom
- sadrži gumicu
- ispis 0.5 mm
- pakiranje: 12
- šifra: 000033671



Olovka tehnička Triplus micro 774

- trokutasti i ergonomski oblik
- kromirani metalni vrh
- ekstra duga gumica s navojem za vrhunske rezultate brisanja
- iskoristivost mine veća od 95%
- dvije debljine ispisa
- pakiranje: 10



- 000001183



- 000001170



Olovka tehnička Protti PRD

- gumirano stablo s metaliziranom klipsom, vrhom i gripom
- sadrži gumicu
- ispis 0.5 mm
- pakiranje: 12
- šifra: 000033672



Olovka tehnička Super Grip H 185

- PVC stablo s gumenim gripom
- s gumicom
- stablo dostupno u 4 boje
- ispis 0.5 mm
- pakiranje: 12



- 000021667
- 000015477
- 000002159
- 000018424



Olovka tehnička H-105

- PVC stablo u 3 boje: crvena, plava i crna
- ispis 0.5 mm
- pakiranje: 12



- 000018441
- 000010357
- 000018442



Olovka tehnička CCH-3

- prozirno PVC stablo s plavim gumenim gripom
- sadrži gumicu
- ispis 0.5 mm
- pakiranje: 12
- šifra: 000012458



Olovka tehnička RBR

- gumirano stablo
- ispis 0.5 mm
- pakiranje: 12
- šifra: 000012444



rotring

Olovka tehnička Tikky

- s gripom
- PVC stablo u sort bojama
- ispis 0.5 mm
- pakiranje: 12



- 000018455
- 000018358
- 000018357
- 000000648
- 000018356



Maped

Olovka tehnička Automatic

- PVC stablo s gumenim gripom
- modernog dizajna
- dostupna u 3 boje
- sadrži gumicu ispod čepa
- ispis 0.5 mm
- pakiranje: 36
- šifra: **000026297**



Connect

Olovka tehnička T-050

- PVC, s gumenim gripom
- s gumicom
- 4 boje stabla
- pakiranje: 12



- 000029631
- 000029628
- 000029629
- 000029630



fornax

Olovka tehnička Grip T-050

- PVC stablo s gumenim gripom
- dostupna u 3 boje
- sadrži gumicu ispod čepa
- ispis 0.5 mm
- pakiranje: 12



- 000026330
- 000026329
- 000026331



RED in BLUE

Olovka tehnička M-5

- PVC stablo s gumenim gripom
- metalni klip
- s gumicom
- sort boje
- ispis 0.5 mm
- pakiranje: 12
- šifra: **000028742**



PIERANTONI

Olovka tehnička Mr. Pen S-175

- s gumicom ispod čepa
- PVC stablo u sort bojama
- ispis 0.5 mm
- pakiranje: 10
- šifra: **000018138**





Mine Mars Carbon 250 03

- 0.3 mm mina za sve tehničke
- lako se briše
- izuzetna otpornost na lomljenje
- 7 tvrdoća
- pakiranje: 12

HB  • 000005119





Mine Mars Carbon 250 05

- 0.5 mm mina za sve tehničke
- lako se briše
- izuzetna otpornost na lomljenje
- 7 tvrdoća
- pakiranje: 12

2B  • 000001052

B  • 000001061

HB  • 000005322

F  • 000001063

H  • 000001066

2H  • 000001118

3H  • 000001053



Mine Mars Carbon Soft 250 05

- 0.5 mm mina za sve tehničke
- lako se briše
- iznimno lako pisanje
- izuzetna otpornost na lomljenje
- pakiranje: 12

HB  • 000023736



Mine Mars Micro Color 254

- 0.5 mm mina za sve tehničke
- u bojama
- izuzetna otpornost na lomljenje
- prikladna za upotrebu na mat folijama, za precrtavanje
- pakiranje: 12

 • 000008570

 • 000008571

 • 000008572



Mine Mars Carbon 250 07

- 0.7 mm mina za sve tehničke
- lako se briše
- izuzetna otpornost na lomljenje
- 7 tvrdoća
- pakiranje: 12

B  • 000021386

HB  • 000003980

H  • 000023672



Mine Mars Carbon 250 09

- 0.9 mm mina za sve tehničke
- lako se briše
- izuzetna otpornost na lomljenje
- 7 tvrdoća
- pakiranje: 12

HB  • 000005120



Mine Mars Carbon 250 13

- 1.3 mm mina za sve tehničke
- lako se briše
- izuzetna otpornost na lomljenje
- pakiranje: 12

HB  • 000012652



Connect

Mine

- 0.5 mm mina
- super polymer
- tvrdoća HB
- pakiranje: 12
- šifra: 000028720



Connect

Mine

- 0.7 mm mina
- super polymer
- tvrdoća HB
- pakiranje: 12
- šifra: 000029290



Mine

- 0.5 mm mina
- tvrdoća HB
- pakiranje: 12
- šifra: 000021955



Mine

- 0.5 mm mina
- tvrdoća HB
- pakiranje: 12
- šifra: 000012286



Mine za šestar 556 E4 4/1

- PVC pakiranje
- tvrdoća HB
- izuzetna otpornost na lomljenje
- pakiranje: 20

HB  • 000011995



**Mine 255**

- duljina 60 mm
- prikladne za tehničke olovke za crtanje
- inovativni mehanizam s gumbom za punjenje minama
- izuzetna otpornost na lomljenje
- lako se briše
- 2 tvrdoće, 2 debljine ispisa
- pakiranje: 12

0.5 mm
HB • 000010550

0.7 mm
HB • 000010551

**Mine Mars Carbon 200-HB**

- 2 mm mina
- duljina 130 mm
- 7 tvrdoća
- pakiranje: 12

HB • 000001903

OLOVKE SUHE

**Olovka suha Mars Lumograph 100 G6**

- komplet u limenoj kutiji
- tvrdoće: 8B, 7B, 6B, 4B, 2B i HB
- pakiranje: 10
- šifra: **000008519**

**Olovka suha Mars Lumograph 100 G12**

- komplet u limenoj kutiji
- tvrdoće: 6B, 5B, 4B, 3B, 2B, B, HB, F, H, 2H, 3H i 4H
- pakiranje: 5
- šifra: **000008517**

**Olovka suha Mars Lumograph 100 G12S**

- komplet u limenoj kutiji
- tvrdoće: 8B, 7B, 6B, 5B, 4B, 3B, 2B, B, HB, F, H i 2H
- pakiranje: 5
- šifra: **000008518**

**Olovka suha Lumograph**

- sadrži: 6 olovki suhih (6B, 4B, 2B, B, HB, 2H), gumicu i šiljilo
- blister pakiranje
- pakiranje: 1
- šifra: **000028390**





STAEDTLER®

Lyrics are still
written by hand.
OK COMPUTER?

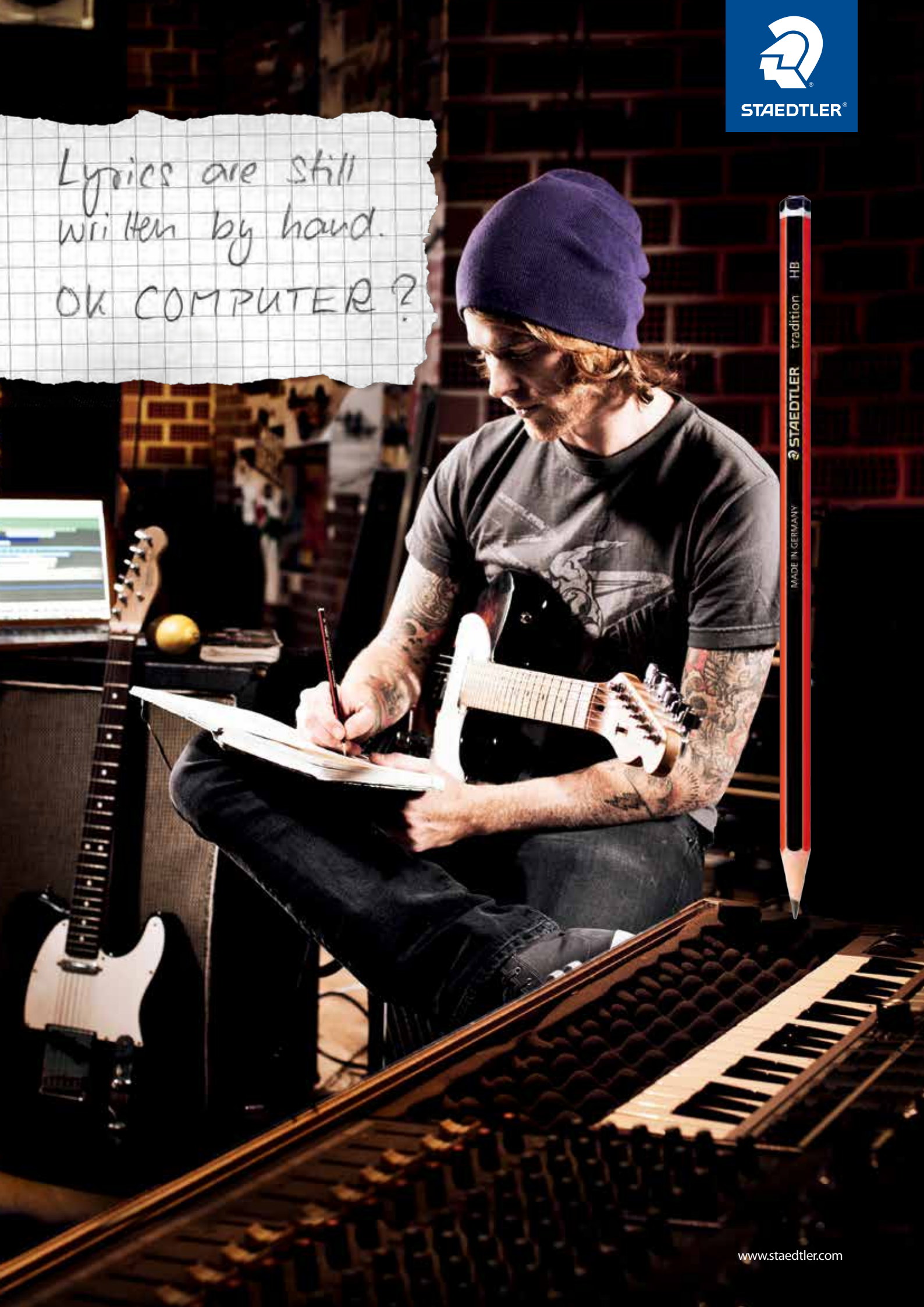

MADE IN GERMANY

STAEDTLER tradition HB



Olovka suha Lumograph













- raspon od 16 tvrdoća
- izuzetna otpornost na lomljenje
- pakiranje: 12

8B  • 000011978	HB  • 000021162
7B  • 000021382	F  • 000020502
6B  • 000011977	H  • 000021161
5B  • 000021160	2H  • 000009052
4B  • 000015029	3H  • 000009053
3B  • 000021159	4H  • 000019172
2B  • 000021380	5H  • 000019173
B  • 000021383	6H  • 000021298



Olovka suha Tradition 110

- kvalitetna olovka
- raspon od 12 tvrdoća
- izuzetna otpornost na lomljenje
- lako se briše
- pakiranje: 12

6B  • 000010986	HB  • 000010978
5B  • 000010985	F  • 000010977
4B  • 000010983	H  • 000011274
3B  • 000010981	2H  • 000010980
2B  • 000010979	3H  • 000010982
B  • 000010976	4H  • 000010984







Olovka suha Noris Eco 180 30

- olovka visoke kvalitete
- izvrsna otpornost na lomljenje
- ekološki proizvod, proizvedena bez otapala
- značajno povišeno iskorištenje drveta iz svakog stabla
- dvostruko dulje pisanje
- tvrdoća HB
- pakiranje: 12
- šifra: 000021594



Olovka Noris 120

- visokokvalitetna olovka
- raspon od 5 tvrdoća
- izuzetna otpornost na lomljenje
- lako se briše
- pakiranje: 12

2B  • 000001085
B  • 000010987
HB  • 000003056
H  • 000010988
2H  • 000001093



Olovka suha Noris 122

- olovka visoke kvalitete
- lako se briše
- promjer mine 2 mm
- sa gumicom za brisanje
- ne sadrži PVC niti latex
- mina HB
- pakiranje: 12

HB  • 000002437
--



Olovka suha Noris 183

- olovka visoke kvalitete
- ergonomski, trokutastog oblika
- mina otporna na lomljenje
- promjer mine 2 mm
- tvrdoća HB
- pakiranje: 12

HB  • 000032192
--



Olovka suha Norica

- glatke strukture
- odlična otpornost na lomljenje
- tvrdoća HB
- pakiranje: 12

HB  • 000019578
--



Olovka suha Norica

- s gumicom
- glatke strukture
- odlična otpornost na lomljenje
- tvrdoća HB
- pakiranje: 12

HB  • 000019599
--





Olovka suha Wopex Neon

- olovka napravljena od Wopex-a, što znači da je 70% od prirodnog drveta
- omogućuje dugotrajnije pisanje
- mekane teksture i glatkog pisanja
- tvrdoća HB
- pakiranje: 12

- 000030483
- 000026102
- 000026103
- 000026105
- 000026104
- 000030484



Olovka suha Minerva 130

- olovka standardne kvalitete
- lako se briše
- lako se oštiri s bilo kojim kvalitetnim šiljilom
- promjer mine 2 mm
- tvrdoća HB
- pakiranje: 12

HB • 000008562



Olovka suha

- ergonomski oblikovana
- s mekanim gripom
- vrhunske kvalitete
- tvrdoća HB
- PVC čaša
- pakiranje: 72

HB • 000026348

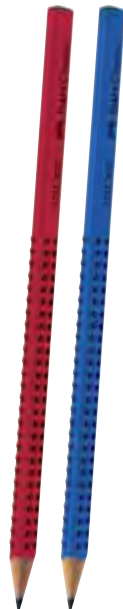

Olovka suha

- trokutasta
- ergonomski oblikovana
- s mekanim gripom
- vrhunske kvalitete
- tvrdoća HB
- PVC čaša
- pakiranje: 72

HB • 000019623



Olovka suha

- trokutasta
- ergonomski oblikovana s gumicom
- s mekanim gripom
- vrhunske kvalitete
- tvrdoća HB
- PVC čaša
- pakiranje: 72

HB • 000019622



Olovka suha Sparkle

- ergonomski oblikovana
- trokutasta
- blistavi gliter
- vrhunske kvalitete
- tvrdoća B
- pakiranje: 12

- 000028680
- 000028671
- 000032241
- 000032239
- 000032240
- 000028681



Olovka suha Black Peps

- blister pakiranje
- ergonomski oblikovana
- tvrdoća HB
- pakiranje: 12

HB • 000015642



Olovka suha Black Peps

- blister pakiranje
- olovka suha s gumicom
- ergonomski oblikovana
- tvrdoća HB
- pakiranje: 12

HB • 000015643



Connect

Olovka suha Metallic

- tvrdoća HB
- sort metalik motivi
- display pakiranje
- pakiranje: 72

HB  • 000030057



Connect

Olovka suha 104

- olovka suha s gumicom
- s natpisima
- tvrdoća HB
- sort boje
- pakiranje u čaši
- pakiranje: 72

HB  • 000028574



Connect

Olovka suha 777

- tvrdoća HB
- pakiranje: 12

HB  • 000028575



Connect

Olovka suha Black

- olovka s gumicom
- tvrdoća HB
- sort crne olovke s neon gumicama
- display pakiranje
- pakiranje: 72

HB  • 000030055



Connect

Olovka suha 444

- tvrdoća HB
- sort boje
- pakiranje u čaši
- pakiranje: 72

HB  • 000028576



Olovka suha

- tvrdoća HB
- pakiranje: 288

HB  • 000027275



Connect

Olovka suha 101

- olovka suha s gumicom
- tvrdoća HB
- sort boje
- pakiranje u čaši
- pakiranje: 72

HB  • 000028577



Connect

Olovka suha

- trokutasta
- tvrdoća HB
- blister pakiranje
- pakiranje: 12

HB  • 000026342



Connect

Olovka suha Document Copy

- šiljena na oba kraja
- permanentna
- za potpisivanje dokumenata, čekova...
- boja mine: crvena/plava
- pakiranje: 12
- šifra: **000031711**





Olovka suha tablica množenja 1822

- olovka standardne kvalitete
- s gumicom za brisanje
- ne sadrži PVC niti latex
- s prikazom tablice množenja
- promjer mine 2 mm
- tvrdoća HB
- pakiranje u čaši
- pakiranje: 72

HB • 000017482



Olovka suha matematička formula 1810

- olovka standardne kvalitete
- s prikazom matematičkim formulama na sivoj pozadini
- promjer mine 2 mm
- tvrdoća HB
- pakiranje u čaši
- pakiranje: 72

HB • 000017481



Connect

Olovka suha tablica množenja 222

- tvrdoća HB
- mina otporna na lomljenje
- lako se oštiri
- pakiranje u čaši
- pakiranje: 72

HB • 000028573



Olovka Lumicolor glasochrom 108 20

- permanentna drvena bojica
- za pisanje i označavanje na gotovo svim površinama: papir, plastika, metal, staklo, drvo, koža i kamen
- ne preslikava se kroz papir
- otporna na vodu
- pakiranje: 12

- 000008520
- 000008521
- 000008522
- 000008523
- 000008524
- 000008730
- 4/1 • 000023746



4/1



Olovka suha 148 40

- olovka namjenjena za tesare
- boja tamno crvena lakirana
- duljina olovke 17,5 cm
- tvrdoća 2H
- pakiranje: 12
- šifra: 000021658

fornax

Olovka suha

- olovka namjenjena za tesare
- boja tamno crvena lakirana
- duljina olovke 17,5 cm
- širina: 1,5 cm
- tvrdoća 2H
- pakiranje: 72
- šifra: 000033488





Set pisači Noris Eco 180 30 SBK-1

- blister pakiranje: 3 olovke suhe Noris Eco, šiljilo 510 50 i gumica 526 B40
- olovka visoke kvalitete
- izvrsna otpornost na lomljenje
- ekološki proizvod, proizvedena bez otapala
- značajno povišeno iskorištenje drva iz svakog stabla
- dvostruko dulje pisanje
- tvrdoća HB
- pakiranje: 10
- šifra: **000021591**



Set pisači Noris 120 R BK3D

- blister pakiranje: 3 olovke suhe Noris 120-2 i gumica 526 50
- visoka kvaliteta
- tvrdoća HB
- pakiranje: 10
- šifra: **000019583**



Set pisači Noris 120

- blister pakiranje: 12 olovki suhih Noris 120, šiljalo metalno i gumica 526 53
- visoka kvaliteta
- tvrdoće: HB
- pakiranje: 6
- šifra: **000030344**



Set pisači Noris 120 511

- blister pakiranje: 2 olovke suhe Noris 120-2, gumica 526 50 i šiljilo 511 004
- visoka kvaliteta
- tvrdoća HB
- pakiranje: 10
- šifra: **000019582**



Olovka suha/Touch Noris

- 2 u 1 olovka sa Stylus funkcijom
- osjetljivi Stylus vrh za precizno korištenje touchscreen uređaja
- lako se briše i oštiri
- promjer mine 2 mm
- mina HB

- **000025601**
- **000025602**





Bojice suhe Noris Club 144

- lakirane u boji mine
- mina je otporna na lomljenje
- lako se oštiri
- kompleti od 12, 24 i 12 kratkih bojica
- pakiranje: 10 (01NC12 i NC12); 5 (NC24)

01NC12 • 000001043

NC12 • 000008563

NC24 • 000008564



01NC12



NC12



NC24



Boje suhe Noris Club 144

- lakirane u boji mine
- mina je otporna na lomljenje
- lako se oštiri
- kompleti od 12 bojica + olovka suha Tradition + gumica
- pakiranje: 10
- šifra: 000023764



Bojice suhe s gumicom Noris Club 144

- blister pakiranje
- komplet od 12 bojica
- pakiranje: 10
- šifra: 000013672



Više u našem
Školskom katalogu.



Bojice suhe Ergosoft 157

- tanke drvene bojice
- jedinstvena protuklizna mekana površina
- ergonomski trokutasti oblik
- mina je otporna na lomljenje
- lako se oštiri
- komplet od 12 bojica u samostojećoj Staedtler kutiji
- pakiranje: 10
- šifra: 000008566



Connect[®]





24/1



12/1



24/1



12/1

Connect

Boje suhe

- otporne na lomljenje
- kompleti od 12 i 24 bojice
- blister pakiranje
- pakiranje: 12 (12/1);
6 (24/1)

12/1 • 000028724

24/1 • 000028725

Connect

Boje suhe

- drvene bojice trokutaste
- promjer mine 3 mm
- otporne na lomljenje
- kompleti od 12 i 24 bojice
- blister pakiranje
- pakiranje: 12 (12/1);
6 (24/1)

12/1 • 000026346

24/1 • 000026347

PRIMO

Boje suhe Morocolor

- blister pakiranje
- komplet od 12 bojica u kutiji
- pakiranje: 6
- šifra: 000013504



Edu

Boje suhe

- blister pakiranje
- komplet od 12 bojica u kutiji
- pakiranje: 6
- šifra: 000012581



GUMICE



Gumica Mars rasor 526 61

- olovka-gumica
- za precizno brisanje
- s četkicom
- pakiranje: 12
- šifra: 000011994



Gumica Mars plastic 528 50

- olovka-gumica
- s mehanizmom za pomicanje gumice i kopčom
- koristi gumicu 528 55
- pakiranje: 10
- šifra: 000000659



penac
JAPAN

Gumica Tri Eraser 301

- gumica u olovci
- s mehanizmom za pomicanje gumice i kopčom
- display pakiranje
- pakiranje: 12
- šifra: **000013767**

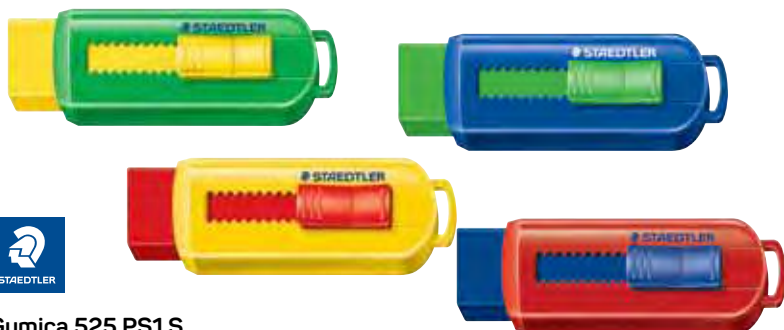

Gumica 525 PS1 S

- s mehanizmom za pomicanje gumice
- dolazi u plastičnoj kutiji
- 4 atraktivne kombinacije boja
- pakiranje: 12
- šifra: **000013598**



Gumica 525 PS1

- s mehanizmom za pomicanje gumice
- dolazi u plastičnoj kutiji
- pakiranje: 12
- šifra: **000031247**



Gumica Eko 525 B

- ekološka, bez plastike i lateksa
- minimalno mrvljenje
- celofanski omotač s praktičnom trakicom za trganje
- klizna košuljica za jednostavno držanje
- display pakiranje



Šifra	Dimenzija (mm)	Pakiranje
000017489	65x23x13	20
000012584	43x19x13	30



Gumica Rasoplast 526

- vrhunska kvaliteta za visoko kvalitetno brisanje
- celofanski omotač s praktičnom trakicom za trganje
- klizna košuljica za jednostavno držanje
- ne oštećuje papir prilikom brisanja
- display pakiranje

Šifra	Dimenzija (mm)	Pakiranje
000001045	65x23x13	20
000008641	43x19x13	30
000021922	43x19x9	45
000008642	33x16x13	40



Gumica Mars plastic 526

- vrhunska tehnologija za vrhunske rezultate
- celofanski omotač s praktičnom trakicom za trganje
- ne oštećuje papir prilikom brisanja
- ne sadrži ftalate niti latex
- otporna na starenje
- display pakiranje

Šifra	Dimenzija (mm)	Pakiranje
000008643	65x23x13	20
000017490	43x19x13	30



Gumica Noris 526 N20

- minimalno mrvljenje
- ne oštećuje papir prilikom brisanja
- ne sadrži ftalat niti latex
- dimenzija: 65x23x13 mm
- pakiranje: 20
- šifra: 000021601

FACTIS®

Gumica S20 softer

- bijela sintetička gumica
- dimenzija: 55,5x23,5x13,5 mm
- display pakiranje
- pakiranje: 20
- šifra: 000028169



FACTIS®

Gumica P20

- sintetička gumica s omotom
- display pakiranje
- pakiranje: 20
- šifra: 000030809



FACTIS®

Gumica P36

- bijela mekana plastična gumica
- dimenzija: 56x19,5x9 mm
- display pakiranje
- pakiranje: 36
- šifra: 000028173



FACTIS®

Gumica LX24

- zelena mekana plastična gumica
- dimenzija: 54,5x20x12 mm
- display pakiranje
- pakiranje: 24
- šifra: 000028172



Gumica rasoplast combi 526 BT30

- vrhunska kvaliteta
- klizna košuljica za jednostavno držanje
- plavi dio gumice je za tintu
- dimenzija: 43x19x13 mm
- display pakiranje
- pakiranje: 30
- šifra: 000008640

Connect

Gumica

- izrađena od sintetske gume
- pakiranje: 36
- šifra: 000029521



BRUNNEN®

Gumica

- gumica s navlakom i mehanizmom za sklapanje
- dimenzija: 59x33x15 mm
- zelene, ljubičaste i crne boje
- display pakiranje
- pakiranje: 12

• 000026255

• 000026253

• 000026254

Connect

Gumica

- izrađena od sintetske gume
- s omotom
- sort boje
- pakiranje: 36
- šifra: 000029520



**Šiljilo Mobius**

- stolno, na baterije
- upotrebljava baterije 2x1.5 V
- jednostavno i brzo šiljenje
- boje sortirane
- pakiranje: 1
- šifra: **000014054**

**Šiljilo Noris 501 180**

- s montažnom sponom za stol
- za sve trokutaste i šesterokutne olovke suhe i olovke u boji od Ø7 mm do Ø11,6 mm
- konus se može podešavati za različiti kut šiljenja
- metalni rezač
- automatski špic-stop
- pakiranje: 1
- šifra: **000025599**

**Šiljilo duplo 512 128**

- za olovke u boji standardne veličine do Ø8.2 mm s kutom od 30°, kao i za debele grafit olovke i bojice do Ø10.2 mm s kutom od 30°
- poklopac sa sigurnosnom blokadom kako bi se izbjeglo slučajno otvaranje
- metalni umetak u šiljilu
- pakiranje: 10
- šifra: **000012237**

**Šiljilo Noris 511 001**

- za obične olovke standardne veličine do Ø8.2 mm s kutom od 23°
- poklopac sa sigurnosnom blokadom kako bi se izbjeglo slučajno otvaranje
- metalni uložak šiljila
- pakiranje: 10
- šifra: **000000089**

**Šiljilo Tradition 511 005**

- za olovke standardne veličine s grafitom do Ø8.2 mm s kutom od 23° za tanke i jasne linije
- poklopac sa sigurnosnom blokadom kako bi se izbjeglo slučajno otvaranje
- poklopac štiti od rasipanja sadržaja
- pakiranje: 10
- šifra: **000013593**

**Connect****Šiljilo 6016**

- PVC
- sort boje
- display pakiranje
- pakiranje: 24
- šifra: **000029529**

**Šiljilo Colour Code**

- duplo šiljilo
- 6 sort boja
- dimenzija: 4x2,5x4 cm
- pakiranje: 12

- **000028661**
- **000028659**
- **000028660**
- **000028663**
- **000028662**
- **000028664**





Šiljilo + gumica

- metalno duplo šiljilo
- dostupno u 3 boje
- dimenzija: 58x42x37 mm
- display pakiranje
- pakiranje: 12

 • 000026268

 • 000026269

 • 000026267



Connect

Šiljilo 8132

- metalno duplo šiljilo u PVC kutiji
- sort boje
- display pakiranje
- pakiranje: 8
- šifra: 000029523



Šiljilo 510 20PR1

- display pakiranje
- metalno duplo šiljilo
- za olovke s grafitom ili minom u boji do Ø10.2 mm s kutom rezanja 30° za široke i mekane linije
- ekstra duga vodilica zbog sprječavanja zaglavljivanja
- pakiranje: 20
- šifra: 000026036



Šiljilo 510 10PR1

- metalno šiljilo za obične olovke standardne veličine do Ø8.2 mm s kutom od 23°
- ekstra duga vodilica zbog sprječavanja zaglavljivanja
- display pakiranje
- pakiranje: 20
- šifra: 000026237



Šiljilo 510 20

- metalno duplo šiljilo
- za olovke s grafitom ili minom u boji do Ø10.2 mm s kutom rezanja 30° za široke i mekane linije
- ekstra duga vodilica zbog sprječavanja zaglavljivanja
- display pakiranje
- pakiranje: 20
- šifra: 00001105



Šiljilo 510 10

- metalno šiljilo za obične olovke standardne veličine do Ø8.2 mm s kutom od 23°
- ekstra duga vodilica zbog sprječavanja zaglavljivanja
- display pakiranje
- pakiranje: 20
- šifra: 00001104



Connect

Šiljilo 6009

- PVC
- sort boje
- display pakiranje
- pakiranje: 24
- šifra: 000029527

Više u našem
Školskom katalogu.





Signir Clasic 364

- označivač s velikim spremnikom za tintu
- pigmentirana tinta otporna na svjetlost
- za papir, fax i fotokopije
- INKJET SAFE - sve boje ne razmazuju inkjet ispise
- brzo se suši
- puni se pomoću pribora 488 64
- 8 neonskih boja
- debljina ispisa oko 1-5 mm
- pakiranje: 10 signira u kutiji
- etui s 4, 6 ili 8 boja



WP4



WP6



- 000008591
- 000008592
- 000008593
- 000008594
- 000008595
- 000008596
- 000008597
- 000008598

- WP4 • 000008587
- WP6 • 000008588
- WP8 • 000008589
- WP4P • 000032098
- WP6P • 000032099
- PWP4 • 000011061
- BK4D • 000012188



WP8



BK4D



PWP4



WP4P



WP6P



Signir Clasic 364 Colors

- označivač s velikim spremnikom za tintu
- pigmentirana tinta otporna na svijetlost
- za papir, fax i fotokopije
- crni signir prekriva tekst i on ostaje čitljiv, ali prilikom kopiranja se ne vidi
- INKJET SAFE - sve boje ne razmazuju inkjet ispise
- brzo se suši
- puni se pomoću pribora 488 64
- 10 boja; etui s 4 ili 6 boja
- debljina ispisa oko 1-5 mm
- pakiranje: 10



- 000033634
- 000033635
- 000033636
- 000033637
- 000033638
- 000033639
- 000033640
- 000033641
- 000033642
- 000033643
- WP4 • 000033644
- WP6 • 000033645



WP4



Signir E-345

- tinta na bazi vode
- za papir, fax i fotokopije
- debljina ispisa oko od 2 do 5 mm
- pakiranje: 10
- etui s 4 ili 6 boja



-  • 000012388
-  • 000022609
-  • 000012390
-  • 000012391
-  • 000012389
-  • 000012392
-  • 000022648
-  • 000022608



4/1



6/1



Signir E-7 Mini

- tinta na bazi vode
- za papir, fax i fotokopije
- 5 sort boja
- debljina ispisa od 1 do 3 mm
- pakiranje: 1
- šifra: **000027531**



1-3mm



Signir Tratto Video

- super fluorescentni označivač
- univerzalna tinta na bazi vode
- za sve vrste papira
- 6 boja
- debljina ispisa oko 1-5 mm
- pakiranje: 10

-  • 000014746
-  • 000014762
-  • 000014775
-  • 000014756
-  • 000014757
-  • 000014781



1-5mm



**Signir E-66**

- tinta na bazi vode
- za papir, fax i fotokopije
- 4 boje
- debljina ispisa oko 1-4 mm
- pakiranje: 10



- 000022633
- 000022632
- 000022634
- 000022575

**foroffice****Signir**

- za sve vrste papira
- 5 boja
- debljina ispisa oko 2-5 mm
- pakiranje: 12
- set 4/1



- 000029556
- 000029560
- 000029557
- 000029558
- 000029559
- 000029561



4/1

**Signir 128 64**

- u olovci
- trokutasti oblik
- jumbo veličina
- neon boje
- pogodan za korištenje na tankom osjetljivom papiru jer boja ne prolazi kroz papir
- pakiranje: 12

- 000032208
- 000032210
- 000032209
- 000032211

**Signir Lak**

- 6 sort boja
- display pakiranje
- pakiranje: 30
- šifra: 000028908

foroffice®





Flomaster Noris Club 326

- ostaje danima bez poklopca bez isušivanja
- tinta na bazi vode
- 20 sjajnih boja
- 13 boja raspoloživo pojedinačno
- debljina ispisa oko 1 mm
- dostupan pojedinačno i u etuima s 6, 10 ili 20 boja
- pakiranje: 10 flomastera u kutiji (pojedinačne boje); 10 (WP6, WP10); 5 (WP20)

- 000009117
- 000009118
- 000008537
- 000008535
- 000008536



Flomaster Noris Club 320 obostrani

- blister pakiranje
- debljina ispisa oko 1.0 ili 3.0 mm
- DRY SAFE tinta – može ostati danima bez poklopca bez isušivanja
- polipropilensko tijelo jamči dugotrajnost upotrebe
- lako se ispire s vodom
- pakiranje: 10

- 000011446
- 000011447



Flomaster Noris 325

- blister pakiranje
- debljina ispisa 1 mm
- lako se pere s tekstila
- blister pakiranje
- pakiranje: 10

- 000028364
- 000028365



Flomaster Turbo Color Giotto

- dugotrajni, super otporni flomasteri
- tinta na bazi vode
- komplet od 12 flomastera
- debljina ispisa 2.8 mm
- pakiranje: 10
- šifra: 000014738



Flomaster

- ujednačeno istjecanje tinte
- dvostruki zatvarač sprečava sušenje tinte
- dvije debljine ispisa
- dugi vijek pisanja
- specijalna fluorescentna boja
- komplet od 12 flomastera
- pakiranje: 10
- šifra: 000021662





Flomaster Funtastics E-14

- s ergonomski oblikovanim gripom
- za pisanje po papiru, kartonu
- lako ispiranje s kože i tekstila
- širina ispisa 3 mm
- komplet od 10 boja
- blister pakiranje
- pakiranje: 10
- šifra: **000026092**



Flomaster E-1200

- za pisanje i crtanje
- tinta na bazi vode
- debljina ispisa 1 mm
- pakiranje: 10
- šifra: **000027192**



Flomaster E-1200

- za pisanje i crtanje
- tinta na bazi vode
- debljina ispisa 1 mm
- pakiranje: 10
- šifra: **000026080**



Flomaster E-1200

- okrugli vrh
- tinta na bazi vode
- PVC kutija
- set od 10 boja
- debljina ispisa oko 0.5-1 mm
- pakiranje: 1
- šifra: **000027119**



Flomaster E-1300

- za pisanje i crtanje
- tinta na bazi vode
- debljina ispisa 3 mm
- pakiranje: 10
- šifra: **000026082**



Flomaster 1340 Zen-Tangling

- s vrhom u obliku kista
- dostupan u kompletu od 10 boja
- blister pakiranje
- pakiranje: 10
- šifra: **000028845**



Flomaster

- komplet od 12 i 24 flomastera
- blister pakiranje
- pakiranje: 24

12/1 • 000026358

24/1 • 000026359



12/1



24/1



Flomaster

- trokutasti oblik
- komplet od 12 flomastera
- lako se pere
- blister pakiranje
- pakiranje: 12
- šifra: **000031805**





Flomaster permanent Lumocolor 313 S

- univerzalan za pisanje po grafoskopskoj foliji i gotovo svim površinama
- pogodan za pisanje na CD/DVD diskovima
- može ostati bez poklopca danima bez isušivanja
- odlična vodootpornost i otpornost na razmazivanje, suši se za par sekundi
- izuzetna kvaliteta boje
- pakiranje: 10



- 000008578
- 000008579
- 000008773
- 000008580
- WP4 • 000008577



WP4



Flomaster permanent Lumocolor 318 F

- univerzalan za pisanje po grafoskopskoj foliji i gotovo svim površinama
- može ostati bez poklopca danima bez isušivanja
- odlična vodootpornost i otpornost na razmazivanje, suši se za par sekundi
- izuzetna kvaliteta boje
- pakiranje: 10



- 000008528
- 000008529
- 000008774
- 000008530
- WP4 • 000008527
- WP3+1 • 000023753



WP4



WP3+1



Flomaster E-141 F

- za pisanje po foliji za projektor, kao i za pisanje po staklu, plastici...
- vodootporna tinta
- 3 boje
- debljina ispisa 0.6 mm
- pakiranje: 10



- 000022580
- 000022581
- 000022579





Flomaster permanent Lumocolor 317 M

- univerzalan za pisanje po grafoskopskoj foliji i gotovo svim površinama
- pogodan za pisanje na CD/DVD diskovima
- može ostati bez poklopca danima bez isušivanja
- odlična vodootpornost i otpornost na razmazivanje, suši se za par sekundi
- izuzetna kvaliteta boje
- pakiranje: 10



- 000008584
- 000008585
- 000019640
- 000008775
- 000016163
- 000008526
- 000008769



WP4



Flomaster permanent Lumocolor 314 B

- univerzalan za pisanje po grafoskopskoj foliji i gotovo svim površinama
- može ostati bez poklopca danima bez isušivanja
- odlična vodootpornost i otpornost na razmazivanje, suši se za par sekundi
- izuzetna kvaliteta boje
- pakiranje: 10



- 000008581
- 000008583



Flomaster permanent Lumocolor Duo 348

- obostrani flomaster s dvije debljine ispisa: F (0.6 mm) i M (1.5 mm)
- univerzalan za pisanje na gotovo svim površinama
- može ostati bez poklopca danima bez isušivanja
- odlična vodootpornost i otpornost na razmazivanje, suši se za par sekundi
- pakiranje: 10



- 000029333
- 000028972
- 000028973
- 000028974



4/1



Marker permanentni Lumocolor 352

- može ostati bez poklopca danima bez isušivanja
- odlična vodootpornost i otpornost na razmazivanje, suši se za par sekundi
- okrugli vrh oko 2 ili 5 mm
- jednostavno punjenje pomoću pribora za punjenje 488 50
- pakiranje: 10 flomastera u kutiji; 5 (WP4)



- 00008552
- 00008553
- 00008554
- 00008791



WP4



Marker permanentni E-400

- za pisanje na gotovo svim površinama: papir, karton, metal, plastika, staklo...
- vodootporan i otporan na toplinu, brzo se suši
- s mogućnošću punjenja
- okrugli vrh 1 mm
- pakiranje: 10



- 000032750
- 000032673
- 000032674
- 000030676



Marker permanentni E-8280

- za označavanje i pisanje na svim površinama
- brzosušuća tinta koja postaje jasno vidljiva pod UV svjetlom
- okrugli vrh 1.5-3 mm
- pakiranje: 10
- šifra: 000030487





OPIS I DEBLJINE OZNAKA ISPISA

S- superfina **F**- fina **M**- srednja **B**- debela



S oko 0.4 mm



F oko 0.6 mm



M oko 1.0 mm



B oko 1.0 ili 2.5 mm



Marker permanentni 3452

- trokutasti marker
- pogodan za skoro sve površine
- vodootporan
- debljina ispisa 1-2 mm
- intenzivne boje
- pakiranje: 10



• 000032212

• 000032213

• 000032214



Marker permanentni E-300

- za pisanje na gotovo svim površinama: metal, plastika, staklo...
- vodootporan i otporan na toplinu, brzo se suši
- s mogućnošću punjenja
- okrugli vrh 1.5-3 mm
- pakiranje: 10 ; 1 (4/1)



• 000022654

• 000022656

• 000022655

• 000022653

4/1 • 000022618



Marker permanentni E-550

- za pisanje na gotovo svim površinama: metal, plastika, staklo...
- vodootporan i otporan na toplinu, brzo se suši
- s mogućnošću punjenja
- okrugli vrh 3-4 mm
- pakiranje: 10



• 000022628

• 000022626

• 000022627

• 000022629





Marker permanentni E-330

- za pisanje na gotovo svim površinama: metal, plastika, staklo...
- voodootporan i otporan na toplinu, brzo se suši
- s mogućnošću punjenja
- kosi vrh 1-5 mm
- pakiranje: 10 ; 1 (4/1)



- 000022658
- 000022660
- 000022659
- 000022657
- 4/1 • 000022617



4/1

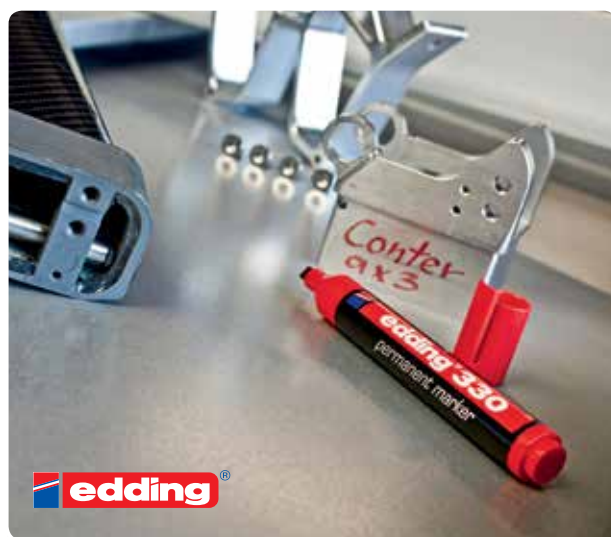

Marker permanentni Lumocolor 350

- može ostati bez poklopca danima bez isušivanja
- odlična voodootpornost i otpornost na razmazivanje, suši se za par sekundi
- kosi vrh oko 2 ili 5 mm
- 2 debljine ispisa
- pakiranje: 10 flomastera u kutiji; 5 (WP4)



- 000008541
- 000008542
- 000012821
- 000008788
- 000012822
- 000008543
- WP4 • 000008790
- WP6 • 000030352



WP4



WP6



Marker permanentni E-390

- za pisanje po svim površinama
- vodootporan i otporan na toplinu, brzo se suši
- kosi vrh 4-12 mm
- pakiranje: 10



- 000022651
- 000022652
- 000028823
- 000022650



Marker permanentni E-500

- za pisanje na gotovo svim površinama: metal, plastika, drvo, staklo...
- vodootporan i otporan na toplinu, brzo se suši
- s mogućnošću punjenja
- kosi vrh oko 2 ili 7 mm
- pakiranje: 10



- 000032748
- 000022631
- 000032702
- 000022630



Marker permanentni Lumocolor 388

- može ostati bez poklopca do 7 dana bez isušivanja
- odlična vodootpornost i otpornost na razmazivanje, suši se za par sekundi
- izuzetno debeli kosi vrh oko 2 ili 12 mm
- jednostavno punjenje pomoću tinte za punjenje 485 23
- crne boje
- pakiranje: 5
- šifra: **000008606**



Tinta za punjenje Lumocolor 485 23

- tinta za punjenje Lumocolor permanentnih markera 385 i 388
- polietilenska bočica
- sadržaj 22 ml
- 4 boje
- pakiranje: 1



- 000008634
- 000008635

MARKERI PERMANENTNI



Marker permanentni E-850

- za pisanje na gotovo svim površinama: metal, plastika, staklo...
- vodootporan i otporan na toplinu, brzo se suši
- s mogućnošću punjenja
- kosi vrh oko 5 ili 16 mm
- pakiranje: 10



- 000022624
- 000022623
- 000022625



fornax

Marker permanentni

- namijenjen za pisanje na raznim površinama
- okrugli vrh 1.5-3 mm
- pakiranje: 1
- šifra: 000018800



foroffice

Marker permanentni

- namijenjen za pisanje na raznim površinama
- okrugli vrh 1.5-3 mm
- pakiranje: 1



- 000029563
- 000029564
- 000029562
- 4/1 • 000029565



DEKORATIVNI MARKERI



Marker E-780

- za pisanje na gotovo svim površinama: metal, plastika, staklo, drvo...
- dobra vidljivost na tamnim kao i na prozirnim površinama
- metalni vrh 0.8 mm
- pakiranje: 10

- 000022543
- 000022540
- 000022541
- 000022542
- 000022539
- 000022544
- 000022545



uni-ball

Marker PX-21

- ispisuje na drvetu, metalu, staklu, plastici, koži, tekstu
- vodootporan, ne izbjeđuje
- debljina ispisa od 0.8-1.2 mm
- pakiranje: 12

- 000015672
- 000015676
- 000015675
- 000015674
- 000015673





Marker 8323

- metalik marker za pisanje i ukrašavanje na svijetlom i tamnom papiru i kartonu
- dobra vidljivost na tamnim kao i na prozirnim površinama
- dostupan u zlatnoj i srebrnoj boji
- okrugli vrh od 1-2 mm
- pakiranje: 10



- 000020629
- 000020628



Marker E-791

- za pisanje na gotovo svim površinama: metal, plastika, staklo, drvo...
- dobra vidljivost na tamnim kao i na prozirnim površinama
- okrugli vrh od 1-2 mm
- pakiranje: 10



- 000032571
- 000032572



Marker E-751

- za pisanje na gotovo svim površinama: metal, plastika, staklo, drvo...
- dobra vidljivost na tamnim kao i na prozirnim površinama
- okrugli vrh od 1-2 mm
- pakiranje: 10

- 000022536
- 000022586
- 000022571
- 000022534
- 000022587
- 000022537
- 000022538
- 000022535



Marker E-1200

- za ukrašavanje i dekoraciju
- pogodan i za tamne papire
- tinta na bazi vode
- okrugli vrh od 1-3 mm
- set 6/1
- pakiranje: 10
- sifra: 000026079



Marker E-790

- za pisanje na gotovo svim površinama: metal, plastika, staklo, drvo...
- dobra vidljivost na tamnim kao i na prozirnim površinama
- okrugli vrh od 2-3 mm
- pakiranje: 10

- 000032579
- 000032576
- 000032575
- 000032574
- 000032573
- 000032577
- 000032578





Marker E-74M/75B

- sjajni marker pisanje na gotovo svim površinama: metal, plastika, staklo, koža...
- za ukrašavanje i dekoraciju
- dobra vidljivost na tamnim kao i na prozirnim površinama
- pakiranje: 10

- 000022620  74M
- 000022619  1-2mm
- 000022622  75B
- 000022621  2-3mm



Marker E-755

- sjajni marker pisanje na gotovo svim površinama: metal, plastika, staklo, koža...
- za ukrašavanje i dekoraciju
- dobra vidljivost na tamnim kao i na prozirnim površinama
- pakiranje: 10



- 000022552  1-4mm
- 000022553
- 000022554



uni-ball

Marker PX-20

- ispisuje na drvetu, metalu, staklu, plastici, koži, tekstilu
- vodootporan, ne izbljeđuje
- debljina ispisa od 2.2-2.8 mm
- 15 boja
- pakiranje: 12

- 000020397
- 000011934
- 000011935
- 000011930
- 000011931
- 000011932
- 000003343
- 000002878  2.2-2.8mm



Marker E-750

- za pisanje na gotovo svim površinama: metal, plastika, staklo, drvo...
- dobra vidljivost na tamnim kao i na prozirnim površinama
- okrugli vrh od 2-4 mm
- pakiranje: 10

- 000022590
- 000022595
- 000022593
- 000022592
- 000022598
- 000022589
- 000022588
- 000022591  2-4mm



uni-ball

Marker PX-30

- ispisuje na drvetu, metalu, staklu, plastici, koži, tekstilu
- vodootporan, ne izbljeđuje
- debljina ispisa od 4-8.5 mm
- 7 boja
- pakiranje: 6

- 000009656
- 000010943
- 000010942  4-8.5mm



MARKERI ZA POSEBNU NAMJENU



Marker permanentni E-8850

- za označavanje i pisanje na teško dostupnim površinama: metal, kamen, staklo, drvo i plastika
- voodootporan, brzo se suši
- okrugli vrh 0.7-1 mm
- pakiranje: 10
- šifra: **000031964**



Marker Lumocolor za CD/DVD 310 CDS

- izuzetno mekan vrh, ne oštećuje osjetljivu površinu CD/DVD diskova
- može ostati bez poklopca danima bez isušivanja
- odlična voodootpornost i otpornost na razmazivanje, suši se za par sekundi
- pakiranje: 10 ; 1 (WP4)



WP4



• 000030345

• 000009020

WP4 • 000009019



Marker za CD/DVD E-84

- izuzetno mekan vrh, ne oštećuje osjetljivu površinu CD/DVD i Blu-ray diskova
- voodootporna tinta otporna na razmazivanje
- pakiranje: 10 ; 1 (4/1)



• 000022568

• 000022567

• 000022570

4/1 • 000022616



4/1



Marker za CD/DVD E-8400

- izuzetno mekan vrh, ne oštećuje osjetljivu površinu CD/DVD i Blu-ray diskova
- tinta na bazi vode bez otapala i otporna na razmazivanje
- 4 boje
- pakiranje: 10 ; 1 (4/1)

- 000022662
- 000022663
- 000022664
- 000022661

• 000022649



OPIS I DEBLJINE OZNAKA ISPISA

S- superfina **F**- fina **M**- srednja **B**- debela



S oko 0.4 mm



F oko 0.6 mm



M oko 1.0 mm



B oko 1.0 ili 2.5 mm

foroffice

Marker za CD/DVD

- permanentni
- 3 boje
- debljina ispisa: 1 mm
- pakiranje: 12

- 000029555
- 000029554
- 000029553



Marker permanentni Lumocolor special 319 S / F / M

- ispisuje na raznim površinama
- odlična vodootpornost i otpornost na razmazivanje, suši se za par sekundi
- izuzetno otporan na svjetlost
- 3 debljine ispisa
- 2 boje
- pakiranje: 10



S

• 000009909



M

• 000009908



F

• 000009906

• 000009907



edding[®]

MARKERI I FLOMASTERI ZA TEKSTIL!



edding[®] Textile
washproof up to 60°C/waschfest bis zu 60°C



edding[®] 4600 textile pen 69

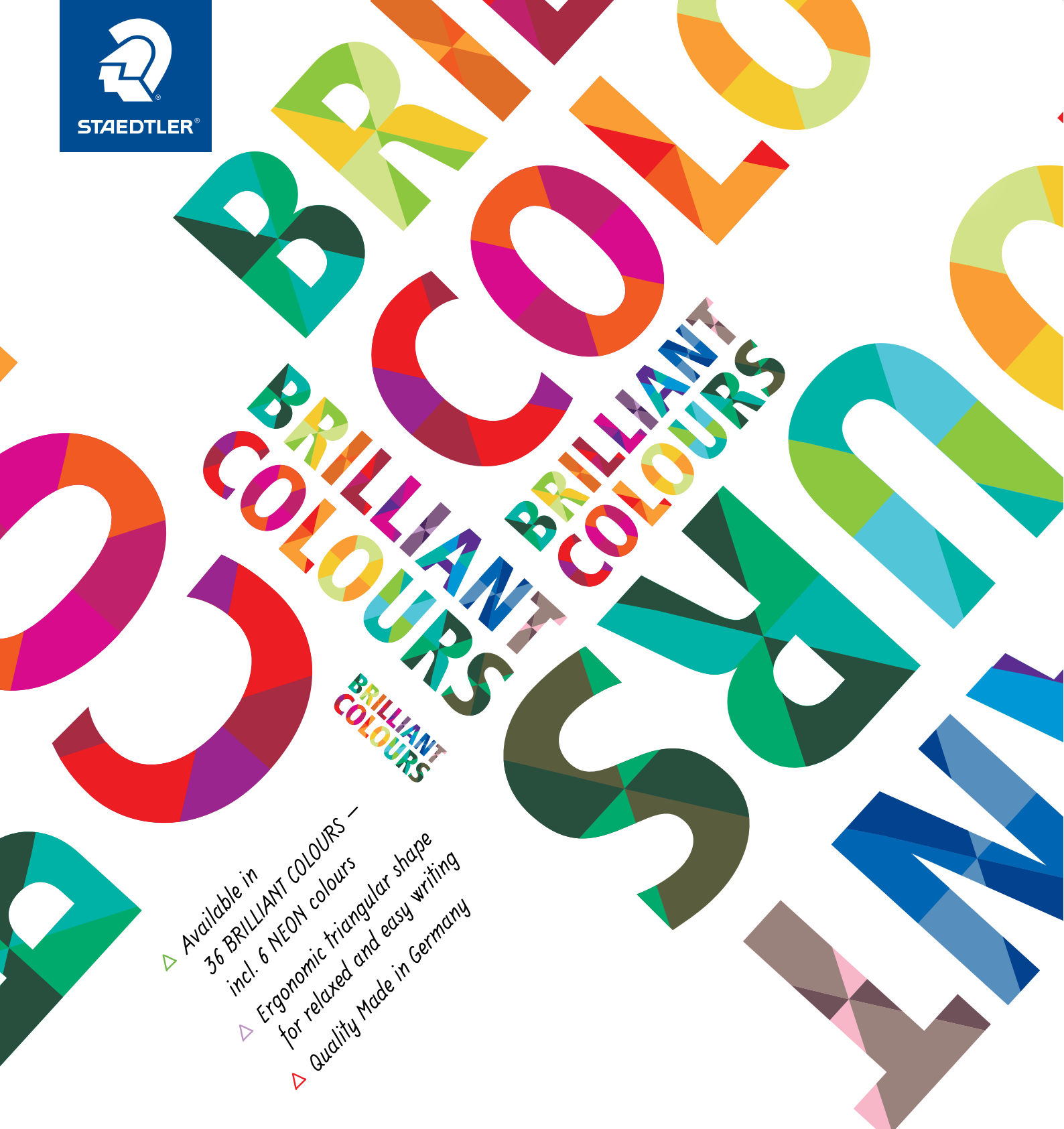

- △ Available in 36 BRILLIANT COLOURS – incl. 6 NEON colours
- △ Ergonomic triangular shape for relaxed and easy writing
- △ Quality Made in Germany

triplus[®] fineliner

0.3 mm

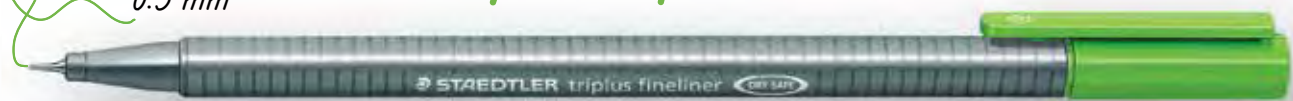



Marker za tekstil E-4600

- marker na bazi vode
- za oslikavanje i ukrašavanje raznih tekstila: pamuk, svila, lan...
- vodootporan na većini materijala do 60°C nakon učvršćivanja glačalom
- okrugli vrh
- širina ispisa 1 mm
- blister pakiranje 10/1
- pakiranje: 10
- šifra: **000026078**



Marker za tekstil E-4500

- za oslikavanje i ukrašavanje raznih tekstila: pamuk, svila, lan...
- vodootporan na većini materijala do 60°C nakon učvršćivanja glačalom
- brzo se suši
- pakiranje: 10

- 000022642
- 000022639
- 000022640
- 000022641
- 000022638





Marker za tekstil Funtastics E-17

- 5 živih boja na bazi vode
- za pisanje po tekstilu
- vodootporan na većini materijala do 60°C nakon učvršćivanja glačalom
- širina ispisa 2-3 mm
- blister pakiranje
- pakiranje: 10
- šifra: **000026098**



Marker industrijski E-8750

- idealan za pisanje po masnim i prašnjavim površinama
- otporan na vremenske uvjete
- brzo se suši
- pakiranje: 10

- 000022550
- 000022547
- 000022548
- 000022549
- 000022546



Marker industrijski E-950

- idealan za glatke i hrapave površine: metal, kamen i drvo
- otporan na vremenske uvjete
- pakiranje: 10
- šifra: **000031242**





Marker za gume E-8050

- idealan za pisanje po autogumama i gumenim površinama
- boja ispisa: bijela
- pakiranje: 10
- šifra: 000022551



MARKERI FLIPCHART



Marker Lumocolor flipchart 356

- idealan za upotrebu na papiru jer tinta ne prodire na drugu stranu papira
- može ostati bez poklopca danima bez isušivanja
- suši se za par sekundi
- tinta na bazi vode
- jednostavno punjenje pomoću pribora za punjenje 488 56
- debljina ispisa oko 2 mm
- komplet od 4 boje
- pakiranje: 10; 5 (WP4)



• 000008824

• 000008828

• 000008829

WP4 • 00000199



Pribor za punjenje Lumocolor flipchart markera 356

- za jednostavno i čisto punjenje
- umetnite marker u pribor za punjenje, nakon par minuta marker je spreman za upotrebu, a nakon 3-4 sata potpuno je napunjen
- sadržaj 30 ml
- pakiranje: 4



WP4



Marker whiteboard E-360

- idealan za pisanje po bijelim pločama
- može ostati nekoliko dana bez poklopca bez isušivanja
- brzo se suši
- pakiranje: 10



- 000022669
- 000022666
- 000022667
- 000022668
- 000022670
- 000022665



Marker Lumocolor whiteboard 351

- može ostati bez poklopca danima bez isušivanja
- briše se suhim postupkom s bijelih ploča i površina poput stakla i porculana
- brzo sušenje
- punjenje pomoću pribora za punjenje 488 51
- debljina ispisa: zaobljen vrh oko 2 mm
- 6 boja
- komplet od 4 ili 6 boja
- pakiranje: 10 (pojedinačne boje); 5 (WP4 i WP6)



- 000008547
- 000008548
- 000008794
- 000008549
- 000008795
- 000008550
- WP4 • 000008544
- WP6 • 000008545

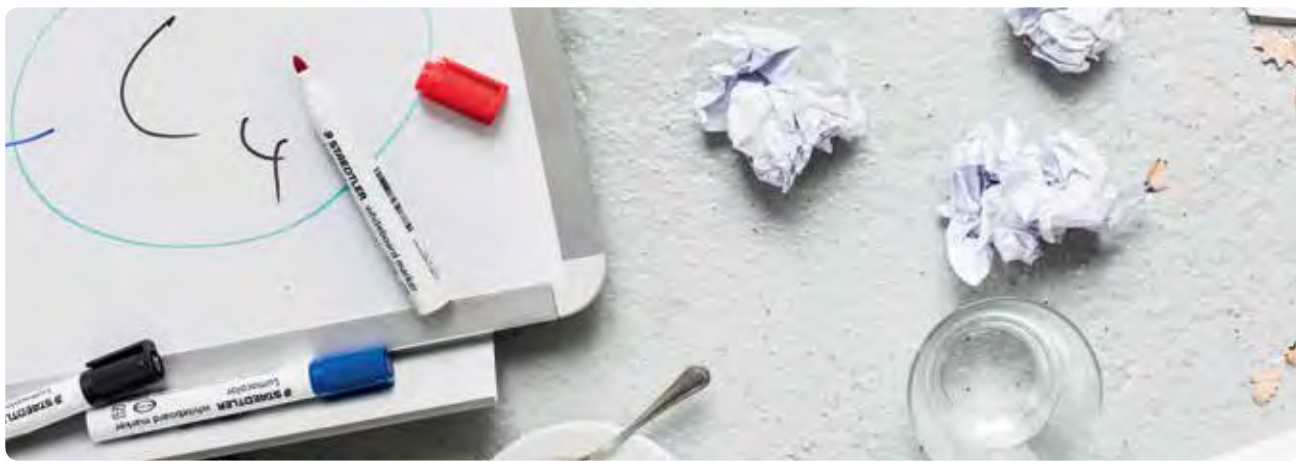



Čisto i brzo brisanje!

Lumocolor marker za bijelu ploču: suho brisanje bez ostataka na površinama, kao što su staklo i porculan. Brzo sušenje i bez mirisa. Najbolji - kada je u pitanju čisto označavanje i jednostavno uklanjanje!

Uvjerite se!



Marker whiteboard E-363

- idealan za pisanje po bijelim pločama
- može ostati nekoliko dana bez poklopca bez isušivanja
- brzo se suši
- pakiranje: 10

-  • 000022611
-  • 000022672
-  • 000022673
-  • 000022612
-  • 000022610
-  • 000022671



Marker neon board E-725

- idealan za pisanje po bijelim i tamnim pločama
- tinta neutralnog mirisa
- jake neonske boje
- pakiranje: 10

-  • 000025518
-  • 000022596
-  • 000022594
-  • 000022597
-  • 000022585



Marker Lumocolor whiteboard 351 B

- može ostati bez poklopca danima bez isušivanja
- briše se suhim postupkom s bijelih ploča i površina poput stakla i porculana
- brzo sušenje
- punjenje pomoću pribora za punjenje 488 51
- debljina ispisa kosog vrha 2-5 mm
- komplet od 4 boje
- pakiranje: 5
- šifra: **000008792**



MARKERI WHITEBOARD



FABER-CASTELL

Marker Whiteboard

- briše se suhim postupkom s bijelih ploča i površina poput stakla i porculana
- brzo sušenje
- komplet od 6 boja
- pakiranje: 1
- šifra: **000030849**



Quartet®

Marker Whiteboard

- idealan za korištenje na pločama piši-briši
- komplet od 4 neon boje
- pakiranje: 1
- šifra: **000026651**

foroffice®

Marker Whiteboard

- ispisuje na bijelim pločama
- nepermanentni
- okrugli vrh
- debljina ispisa: 1,5-3 mm
- pakiranje: 12

- **000029548**
- **000029549**
- **000029547**



MARKERI ZA PLOČU I STAKLO



edding®

Marker E-4090

- tekuća kreda na bazi vode sa neutralnim mirisom
- otporan na svijetlo
- za pisanje po staklu, tamnoj ploči, prozorima
- briše se vlažnom krpom
- set od 4 fluorescentne boje
- ravni vrh
- debljina ispisa 4-15 mm
- šifra: **000026088**



edding®

Marker Funtastics E-16

- 5 živih boja
- za pisanje po staklu, tamnom papiru
- lako ispiranje vodom i sapunom
- širina ispisa 2-6 mm
- blister pakiranje
- pakiranje: 10
- šifra: **000026097**





Fineliner Triplus 334

- sa superfinim ojačanim metalnim vrhom
- ergonomski oblik
- može ostati bez poklopca danima bez isušivanja
- tinta na bazi vode
- 26 sjajnih boja
- debljina ispisa oko 0.3 mm
- komplet od 4, 10, 12 ili 20 boja
- pakiranje: 10
- pakiranje 334 PR12 u tubi 12/1



SB20



M15



PR12

• 000008804

• 000008813

• 000008806

• 000008814

• 000033622

• 000008808

• 000008812

• 000033623

• 000008807

• 000008805

• 000033624

• 000008811

• 000008816

• 000033625

• 000008817

• 000008819

• 000033626

• 000008815

• 000008820

• 000033627

• 000008818

• 000008822

• 000033628

• 000008810

• 000008821

• 000033629

• 000008809

• 000008823

• 000033630

• 000030346

• 000030349

• 000033631

• 000030347

• 000030350

• 000033632

• 000030348

• 000030351

• 000033633

SB4 • 000001967

SB10 • 000008803

SB20 • 000008802

PR12 • 000009741

M15 • 000030463



Fineliner Triplus 334 Neon

- sa superfinim ojačanim metalnim vrhom
- ergonomski oblik
- može ostati bez poklopca danima bez isušivanja
- tinta na bazi vode
- debljina ispisa oko 0.3 mm
- komplet od 6 boja
- pakiranje: 10
- šifra: 000025598



Fineliner Triplus 334 Pastel

- sa superfinim ojačanim metalnim vrhom
- ergonomski oblik
- može ostati bez poklopca danima bez isušivanja
- tinta na bazi vode
- debljina ispisa: 0.3 mm
- komplet od 6 boja
- pakiranje: 10
- šifra: 000032206





Fineliner E-55

- metalni vrh
- tinta na bazi vode
- metalna kutija
- set od 10 ili 16 boja
- debljina ispisa oko 0.3 mm
- pakiranje: 1



10/1 • 000026086

16/1 • 000026087



10/1

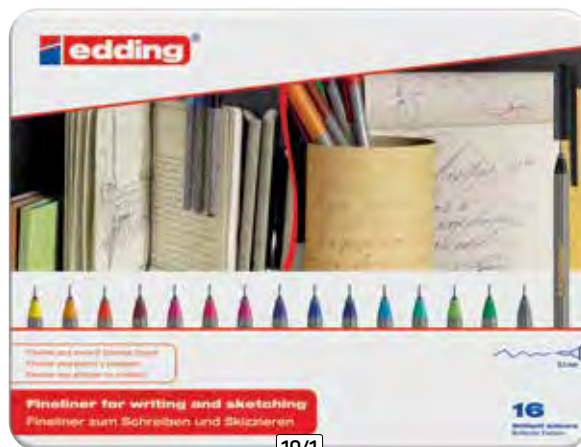

10/1



Fineliner E-68

- vodootporna pigmentirana tinta
- idealan za dokumente i potpisivanje
- 3 boje
- debljina ispisa oko 0.4 mm
- pakiranje: 10



• 000022636

• 000022637

• 000022635



Fineliner E-89

- metalni vrh
- tinta na bazi vode
- plava boja ili set od 10 boja
- debljina ispisa oko 0.3 mm
- pakiranje: 10; 1 (10/1)



• 000024635

10/1 • 000027532



10/1



Fineliner Pin-200

- idealan za precizno pisanje, te tehničko crtanje
- s vodootpornom tintom, otpornom na svjetlost
- raspoloživ u 3 boje
- 5 vrsta debljina ispisa
- pakiranje: 12



0.1 mm

• 000001644

• 000003895

• 000004391

0.2 mm

• 000001724

• 000003903

• 000002059

0.3 mm

• 000001836

• 000003459

• 000003904

0.5 mm

• 000001002

• 000002807

• 000001546

0.8 mm

• 000009655

• 000009654

• 000003104





Rapidograf Mars matic 700

- za maksimalnu preciznost
- cjevčica je presvučena tvrdim kromom
- nema sušenja tinte
- trostruko označavanje debljine ispisa
- za upotrebu na crtačem papiru i papiru za precrtavanje, te mat foliji za skiciranje
- puni se iz bočice ili uloška
- 14 debljina ispisa
- pakiranje: 1



700 M

	0.13 mm	• 000017497
	0.18 mm	-
	0.25 mm	-
	0.35 mm	-
	0.5 mm	• 000001141
	0.7 mm	• 000011155
	1.0 mm	• 000010549

700

	0.1 mm	• 000004128
	0.2 mm	• 000003913
	0.3 mm	• 000003312
	0.4 mm	• 000011156
	0.6 mm	• 000011157
	0.8 mm	• 000011158
	1.2 mm	-



Tinta Mars matic 745 za rapidograf

- za upotrebu na crtačem papiru i papiru za precrtavanje, te mat foliji za skiciranje
- izvrsna kvaliteta reproduciranja
- dostupna u raznim bojama
- sadržaj bočice oko 22 ml
- pakiranje: 1

• 000008740

• 000008739



Rapidograf E-1880

- za maksimalnu preciznost
- vodootporna pigmentirana tinta
- idealan za skiciranje, tehničko crtanje i crtanje po šablonama
- boja tinte: crna
- 5 debljina ispisa
- pakiranje: 10



	0.2 mm	• 000022576
	0.3 mm	• 000022582
	0.5 mm	• 000022583
	0.7 mm	• 000022584
	0.8 mm	• 000022577



Rapidograf E-1800

- vodootporna pigmentirana tinta
- idealan za skiciranje, tehničko crtanje
- 4 boje
- 4 debljine ispisa: 0.1, 0.3, 0.5 i 0.7 mm
- pakiranje: 10



	0.1 mm	• 000032631	• 000032630	• 000032632	• 000032629
	0.3 mm	• 000032627	• 000032626	• 000032628	• 000032625
	0.5 mm	• 000022556	• 000022557	• 000022555	• 000032624
	0.7 mm	• 000022559	• 000022560	• 000022558	• 000032623





Kreda 236

- permanentna kreda u boji
- moguća primjena na staklu, koži, tekstilu, kamenu, metalu, plastici i drvu
- otporna na vodu
- dostupna u 4 boje
- promjer oko 12 mm
- pakiranje: 12

• 000017959

• 000017960

• 000011985

• 000008569



Kreda školska

- besprašna bijela kreda
- zahvaljujući posebnom premazu prsti ostaju čisti prilikom korištenja
- jednostavno se briše
- blister pakiranje
- pakiranje: 12/1
- šifra: 000028361



Kreda školska

- bijela okrugla kreda
- promjer: 10 mm
- dužina: 80 mm
- pakiranje: 10/1
- šifra: 000009674



Kreda školska

- blister pakiranje
- bijela okrugla kreda
- promjer: 9 mm
- dužina: 80 mm
- pakiranje: 10/1
- šifra: 000026295



Kreda školska

- besprašna bijela kreda
- promjer: 9 mm
- dužina: 80 mm
- pakiranje: 10/1
- šifra: 000030937



Kreda školska u boji

- besprašna kreda
- zahvaljujući posebnom premazu prsti ostaju čisti prilikom korištenja
- jednostavno se briše
- blister pakiranje
- pakiranje: 12/1
- šifra: 000028362



Kreda školska u boji

- okrugla kreda u raznim bojama
- promjer: 10 mm
- dužina: 80 mm
- pakiranje: 10/1
- šifra: 000014744



Kreda školska u boji

- blister pakiranje
- 12 različitih boja
- promjer: 9 mm
- dužina: 80 mm
- pakiranje: 12/1
- šifra: 000019482



Kreda školska

- besprašna kreda u boji
- promjer: 9 mm
- dužina: 80 mm
- pakiranje: 10/1
- šifra: 000030938



Držać za kredu

- pakiranje: 24
- šifra: 000019802



PRIMO

Kreda školska

- bijela okrugla kreda
- promjer: 9 mm
- dužina: 80 mm
- pakiranje: 100/1
- šifra: **000019481**



FILO

Kreda školska

- bijela okrugla kreda
- promjer: 10 mm
- dužina: 80 mm
- pakiranje: 100/1
- šifra: **000014136**



Eurokarbon

Kreda školska

- bijela okrugla kreda
- promjer: 11 mm
- dužina: 85 mm
- pakiranje: 100/1
- šifra: **000000364**



Connect

Kreda školska

- besprašna bijela kreda
- promjer: 9 mm
- dužina: 80 mm
- pakiranje: 100/1
- šifra: **000030939**



Connect

Kreda školska

- bijela okrugla kreda
- promjer: 12 mm
- dužina: 90 mm
- pakiranje: 100/1
- šifra: **000032258**



Eurokarbon

Kreda školska u boji

- blister pakiranje
- 12 različitih boja
- pakiranje: 12
- šifra: **000001231**



Eurokarbon

Kreda za vanjsko crtanje

- za asfalt i beton
- blister pakiranje
- 6 boja sortirano
- pakiranje: 90
- šifra: **000001269**



PRIMO

Kreda za vanjsko crtanje Jumbo

- za asfalt i beton
- pakiranje 20 kreda u PP kutiji
- 7 boja sortirano
- pakiranje: 1
- šifra: **000026021**



Connect

Kreda za vanjsko crtanje Jumbo

- za asfalt i beton
- pakiranje 20 kreda u PP kutiji
- 7 boja sortirano
- pakiranje: 1
- šifra: **000030940**

Eurokarbon**Kreda**

- debela kreda u boji
- za signiranje drva
- dostupna u crvenoj i plavoj boji
- pakiranje: 12

- 000003219
- 000001925

**Eurokarbon****Kreda za tekstil**

- za označavanje po tekstilu
- pakiranje: 5

- 000001778
- 000019342
- 000019341



ŠKOLSKI PRIBOR ZA CRTANJE

**Boje voštane 220 NC**

- blister pakiranje
- kompleti od 8, 12 i 16 boja
- pakiranje: 24 (NC8); 12 (NC12, NC16)

- NC8 • 000008568
- NC12 • 000013601
- NC16 • 000008567



NC8



NC12



NC16

**Boje voštane 221NWP12**

- praktične voštane boje
- blister pakiranje
- komplet od 12 boja
- pakiranje: 12
- šifra: 000011445

**PRIMO****Boje voštane Morocolor**

- trokutaste
- komplet od 12 boja, uključujući zlatnu i srebrnu
- blister pakiranje
- pakiranje: 24
- šifra: 000021975

**PRIMO****Boje voštane Morocolor**

- blister pakiranje
- komplet od 12 boja
- pakiranje: 12
- šifra: 000013502

**Connect****Boje voštane Fine**

- blister pakiranje
- komplet od 12 boja
- pakiranje: 24
- šifra: 000028726

**Connect****Boje voštane Jumbo**

- blister pakiranje
- komplet od 12 boja
- pakiranje: 12
- šifra: 000028727

FABER-CASTELL

Boje voštane

- blister pakiranje
- kompleti od 12 i 16 boja
- pakiranje: 10

12/1 • 000030852

16/1 • 000030851



12/1



16/1

Educo

Boje voštane

- blister pakiranje
- komplet od 12 boja
- pakiranje: 48
- šifra: 000019285



PRIMO

Paleta za likovno

- bijela PVC paleta
- s 12 mjesta za boje
- pakiranje: 6
- šifra: 000013535

Educo

Paleta za likovno

- PVC
- bijele boje
- 10 mjesta
- pakiranje: 1
- šifra: 000021984



Educo

Paleta za likovno

- PVC
- bijele boje
- 11 mjesta
- dimenzija: 13x23 cm
- pakiranje: 1
- šifra: 000021985



BRUNNEN

Čaša za tempera boje

- PVC kutija s poklopcem koja zaustavlja curenje vode
- visina kutije 90 mm, a Ø80 mm
- sort boje
- pakiranje: 4
- šifra: 000012729



Connect

Čaša za tempera boje

- PVC kutija s poklopcem koja zaustavlja curenje vode
- visina kutije 75 mm, a 70Ø mm
- sort boje
- pakiranje: 6
- šifra: 000028683



PRIMO

Čaša za tempera boje

- PVC kutija s dvije odvojene posude
- pakiranje: 12
- šifra: 000012730



PRIMO

Čaša za tempera boje

- prozirna PVC čaša
- s 3 mjesta za boje s poklopcem
- pakiranje: 6
- šifra: 000013539

PRIMO**Boje tempera**

- PVC boca
- 500 ml
- pakiranje: 6

- 000013546
- 000013547
- 000013548
- 000013549
- 000013550
- 000014477
- 000013551

**PRIMO****Boje tempera jednobojne**

- PVC kutija
- aluminijska tuba
- količina: 12 ml
- pakiranje: 24

- 000013518
- 000013519
- 000013520
- 000013521
- 000013522
- 000013523

**PRIMO****Boje tempera**

- PVC kutija s 10 i 12 boja
- aluminijska tuba
- količina: 18 ml
- pakiranje: 12 (10/1); 24 (12/1)

10/1 • 000013515

12/1 • 000013516

**Connect****Boje tempera**

- PVC kutija
- aluminijska tuba
- 10 boja
- palete za mješanje boja
- količina: 10 ml
- pakiranje: 10
- šifra: 000015651

**Connect****Boje tempera**

- PVC kutija s paletom za mješanje boja
- aluminijska tuba
- 10 boja
- količina: 18 ml
- pakiranje: 12
- šifra: 000021973

**Connect****Boje tempera**

- PVC kutija
- aluminijska tuba
- 12 boja
- količina: 12 ml
- pakiranje: 24
- šifra: 000021974

**Connect****Boja tempera**

- bijela boja
- aluminijska tuba
- količina: 25 ml
- pakiranje: 30
- šifra: 000028734

Educo**Boje tempera**

- kartonska kutija
- 10 boja
- aluminijska tuba
- količina: 7,5 ml
- pakiranje: 10
- šifra: 000028732

Educo**Boje tempera**

- kartonska kutija
- 10 boja
- aluminijska tuba
- količina: 12 ml
- pakiranje: 10
- šifra: 000028733



Boje vodene Noris Club 888

- PVC kutija s 12 boja
- dolazi s kistom i bijelom temperom
- izrazite boje uz dobru pokrivenost na papiru
- odvojiva posuda s bojama može se premješati
- poklopac je ujedno i paleta za mješanje boja
- pakiranje: 10
- šifra: **000011452**



Boje vodene Morocolor

- PVC kutija
- sadrži: 12 boja, kist i paletu
- izrazite boje uz dobru pokrivenost na papiru
- promjer kruga boje Ø25 mm
- pakiranje: 6
- šifra: **000013512**



Boje vodene Morocolor

- PVC kutija
- sadrži: 12 boja i kist
- izrazite boje uz dobru pokrivenost na papiru
- promjer kruga boje Ø25 mm
- pakiranje: 10
- šifra: **000013513**



Boje vodene

- blister pakiranje
- izrazito pigmentirana boja uz dobru pokrivenost na papiru
- sadrži: 12 boja i kist
- promjer Ø30 mm
- pakiranje: 1
- šifra: **000030839**



Boje vodene

- PVC kutija s 12 boja
- sortirane boje
- Ø25 mm i Ø30 mm
- uz Ø25 mm dođe i paleta za mješanje boja
- blister pakiranje
- pakiranje: 6

Ø25 • 000021972

Ø30 • 000021971



Boje vodene

- PVC kutija s 12 boja
- boje sortirane
- pakiranje: 12
- šifra: **000015652**



Kist za tempera boje

- blister pakiranje
- raznih veličina
- set kistova 3/1
- pakiranje: 10

0 2 4 • 000026218

2 4 6 • 000026219

4 6 8 • 000026220

6 8 10 • 000026221

8 10 12 • 000026222



Kist za tempera boje

- raznih veličina
- pakiranje: 12/1

2 • 000029724

4 • 000029725

6 • 000029726

8 • 000029727

10 • 000029728

12 • 000029729

14 • 000029730

16 • 000029731



Kistovi za vodene i tempera boje

- set kistova 5/1
- 3 kista za vodene boje + 2 kista za tempera boje
- razne veličine
- pakiranje: 10
- šifra: **000028613**



PRIMO**Kist za tempera boje**

- raznih veličina
- pakiranje: 12

- 0 • 000015019
- 2 • 000015020
- 4 • 000015021
- 6 • 000015022
- 8 • 000015023
- 10 • 000015024
- 12 • 000015025
- 14 • 000015026
- 16 • 000015027

**PRIMO****Kist za vodene boje**

- raznih veličina
- pakiranje: 12

- 1 • 000013524
- 2 • 000013525
- 3 • 000013526
- 4 • 000013527
- 5 • 000013528
- 6 • 000013529
- 7 • 000013530
- 8 • 000013531
- 9 • 000013532
- 10 • 000013533

**PRIMO****Kist za vodene boje Morocolor**

- blister pakiranje
- set kistova 5/1
- veličine: 2, 3, 4, 5, 8
- pakiranje: 20
- šifra: 000013536

**Educo****Kist za vodene boje**

- blister pakiranje
- raznih veličina
- set kistova 3/1
- pakiranje: 10

- 2 4 6 • 000026215
- 4 6 8 • 000026216
- 6 8 10 • 000026217

**Educo****Kist za vodene boje**

- raznih veličina
- pakiranje: 12/1

- 4 • 000029732
- 6 • 000029733
- 8 • 000029734
- 10 • 000029735
- 12 • 000029736

**PRIMO****Kist za tempera i vodene boje Morocolor**

- set kistova 192/1
- 96 kistova za vodene + 96 kistova za tempera boje
- raznih veličina
- pakiranje: 1
- šifra: 000020006

**PRIMO****Kistovi za vodene i tempera boje Morocolor**

- set kistova 10/1
- 5 kistova za vodene boje + 5 kistova za tempera boje
- razne veličine
- pakiranje: 1
- šifra: 000019924

BRUNNEN**Pregača dječja**

- s velikom džepičem
- crveno-žuta i plavo-zelena
- s podesivim remenom
- 100% pamuk
- moguće pranje do 40°
- dimenzija: 50 x 57 cm
- pakiranje: 4
- šifra: 000017540

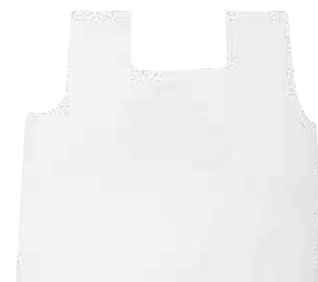
**Educo****Pregača dječja**

- PVC bijela
- za jednokratnu upotrebu
- dimenzija: 39 x 70,5 cm
- pakiranje: 10/1
- šifra: 000028506



JEDNOSTAVNO I BRZO LIJEPLJENJE

U svakom trenutku tesa® će Vam ponuditi najbolje rješenje

Za proizvode iz tesa asortimana ljepila ne postoje nemoguća rješenja, bilo da kreirate obiteljski foto album ili ispunjavate uredske dokumente. Kako bi važni trenuci Vašeg života zauvijek ostali zabilježeni tesa® Vam nudi čisto, brzo i pouzdano lijepljenje. Isprobajte i naše nagrađivano ljepilo-pečat.







tesa

Ljepljiva traka Invisible

- nevidljiva na bijelom papiru i mat-površinama
- može se pisati po njoj
- lako se i brzo uklanja s čvrstih površina
- otporna na starenje
- dimenzija: 19 mm x 33 m
- pakiranje: 10
- šifra: **000012498**



3M

Ljepljiva traka Scotch Magic 810

- nevidljiva ljepljiva traka
- pogodna za sve površine
- otporna na vlagu
- dimenzija: 19 mm x 33 m
- pakiranje: 10
- šifra: **000010489**



Ljepljiva traka Tartan

- nevidljiva ljepljiva traka
- izrađena od sintetičnih vlakana
- otporna na vlagu
- dimenzija 19 mm x 33 m
- pakiranje: 24
- šifra: **000012228**



tesa

Ljepljiva traka Basic

- nevidljiva ljepljiva traka
- tiho odvijanje
- dimenzija 15 mm x 33 m
- pakiranje: 30
- šifra: **000033610**



Ljepljiva traka

- nevidljiva ljepljiva traka
- dimenzija 19 mm x 33 m
- blister pakiranje
- pakiranje: 1
- šifra: **000031212**



Henkel

Ljepljiva traka Pritt

- može se kidati rukom
- prozirna
- dimenzija: 19 mm x 25 m
- blister pakiranje
- pakiranje: 20
- šifra: **000030527**



tesa

Ljepljiva traka

- prozirna ljepljiva traka
- snažno lijepi
- otporna na starenje
- tiho odvijanje
- dimenzija 15 mm x 33 m
- pakiranje: 4/1
- šifra: **000020426**

tesa

Ljepljiva traka

- prozirna ljepljiva traka sa stalkom
- snažno lijepi
- otporna na starenje
- tiho odvijanje
- dimenzija 15 mm x 10 m
- pakiranje: 5/1 + stalak
- šifra: **000015742**



3M

Ljepljiva traka Scotch 508

- prozirna ljepljiva traka
- izrađena od sintetičkih vlakana
- otporna na vlagu
- dimenzija 19 mm x 33 m
- pakiranje: 10
- šifra: **000012226**



tesa

Ljepljiva traka

- prozirna ljepljiva traka
- dobro lijepi, tiho odvijanje
- otporna na starenje
- dimenzija 15 mm x 33 m
- pakiranje: 10
- šifra: **000020382**



Ljepljiva traka

- prozirna ljepljiva traka
- dobro lijepi
- raznih dimenzija



Šifra	Dimenzija	Pakiranje
000019127	15 mm x 10 m	10
000011189	15 mm x 33 m	10
000011190	15 mm x 66 m	10
000011191	19 mm x 33 m	8
000011192	19 mm x 66 m	8



fornax

Ljepljiva traka

- prozirna ljepljiva traka
- dobro lijepi
- pakiranje: 10



Šifra	Dimenzija
000022158	15 mm x 10 m
000012270	15 mm x 33 m
000022159	15 mm x 66 m
000019840	25 mm x 66 m



tesa

Ljepljiva traka

- prozirna ljepljiva traka
- snažno lijepi
- otporna na starenje
- tiho odvijanje

Šifra	Dimenzija	Pakiranje
000015743	15 mm x 10 m	50
000012011	15 mm x 33 m	30



Ljepljiva traka

- prozirna ljepljiva traka na stalku
- dimenzija 15 mm x 10 m
- pakiranje: 120
- šifra: **000011188**



tesa

Ljepljiva traka

- prozirna ljepljiva traka
- snažno lijepi
- otporna na starenje
- tiho odvijanje
- dimenzija: 25 mm x 66 m
- pakiranje: 6
- šifra: **000006387**

LJEPLJIVE PAKIRNE TRAKE

tesa

Ljepljiva pakirna traka

- namjenjena za zatvaranje kutija i paketa
- bučno, lako odmatanje
- prirodno gumeno ljepilo jamči sigurno zatvaranje na različitim temperaturama
- kvalitetna i pogodna za uporabu uz sve Tesa ručne dispensere
- dimenzija: 48 mm x 66 m
- pakiranje: 6

Šifra	Dimenzija	Boja
000006385	48 mm x 66 m	prozirna
000006386	48 mm x 66 m	bijela
000006379	48 mm x 66 m	smeđa





Ljepljiva pakirna traka Hot melt

- namjenjena za zatvaranje kutija i paketa
- sintetičko gumeno ljepilo jamči dobro zatvaranje na sobnoj temperaturi od 8 - 30°C
- dobro ljepljenje, kao i odljepljivanje
- pogodna za uporabu uz sve Tesa ručne dispensere
- dimenzija: 48 mm x 66 m
- pakiranje: 6



Šifra	Dimenzija	Boja
000019232	48 mm x 66 m	prozirna
000019233	48 mm x 66 m	smeđa

fornax

Ljepljiva pakirna traka

- solvent
- namjenjena za zatvaranje kutija i paketa
- dimenzija: 48 mm x 66 m
- pakiranje: 6



Šifra	Dimenzija	Boja
000026305	48 mm x 66 m	prozirna
000026304	48 mm x 66 m	smeđa

foroffice

Ljepljiva pakirna traka

- akrilna
- namjenjena za zatvaranje kutija i paketa
- dimenzija: 48 mm x 66 m
- pakiranje: 6



Šifra	Dimenzija	Boja
000022160	48 mm x 66 m	prozirna
000019839	48 mm x 66 m	smeđa



Ljepljiva pakirna traka

- raznih boja
- dimenzija: 50 mm x 66 m
- pakiranje: 6



Šifra	Dimenzija	Opis
000011182	50 mm x 66 m	plava
000011183	50 mm x 66 m	žuta
000011184	50 mm x 66 m	crvena
000023695	50 mm x 66 m	zelena



Ljepljiva pakirna traka Hot melt

- namjenjena za automatsko pakiranje
- sintetičko gumeno ljepilo jamči dobro zatvaranje na sobnoj temperaturi od 8 - 30°C
- dobro ljepljenje, kao i odljepljivanje
- dimenzija: 48 mm x 990 m
- pakiranje: 6
- šifra: **000018668**



tesa

**Ljepljiva traka za označavanje**

- namjenjena za označavanje prostora koji mogu biti opasni
- izrađena od PVC-a
- čvrsto lijepi na različite plohe
- otporna na slabe kemikalije i otapala
- dostupna u žuto/crnoj i crveno/ bijelom kombinaciji
- dimenzija 50 mm x 33 m
- pakiranje: 6

 • 080000065

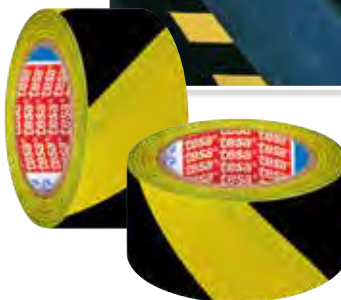
 • 080000062

tesa

**Traka za označavanje**

- namjenjena za označavanje i upozorenje prostora koji mogu biti opasni
- izrađena od polietilena
- izrazito jaka i izdržljiva
- dostupna u crveno/ bijelom kombinaciji
- dimenzija 80 mm x 100 m
- pakiranje: 4
- šifra: 000030333



STALCI ZA LJEPLJIVU TRAKU

3M

Stalak za ljepljivu traku Štikla 810D

- plastični crni stalak u obliku štikle
- s metalnim nožem
- dostupan u crnoj i rožoj boji
- za traku veličine 10/19 mm x 33 m
- pakiranje: 12

 • 000021805

 • 000017702



3M

Stalac za ljepljivu traku C60

- s trakom Magic 810 (19 mm x 33 m nevidljiva)
- stabilni plastični stalak s metalnim nožem
- dostupan u dvije boje
- za traku veličine 10/19 mm x 33 m
- pomična ležišta za trake
- pakiranje: 1

• 000012684

• 000012683



3M

Stalac za ljepljivu traku C38

- s trakom Magic 810 (19 mm x 33 m nevidljiva)
- stabilni plastični crni stalak
- napravljen je od reciklirane plastike
- s metalnim nožem
- za traku veličine 10/19 mm x 33 m
- pakiranje: 1
- šifra: 000010512



siam

Stalac za ljepljivu traku MT33 1300S

- plastični stalak crne boje
- s metalnim nožem
- za traku veličine 10/19 mm x 33 m
- pakiranje: 1
- šifra: 000006816

siam

Stalac za ljepljivu traku MT33 1300P

- plastični stalak
- crne boje
- s metalnim nožem
- za traku veličine 10/19 mm x 33 m
- pakiranje: 1
- šifra: 000006668



CIAC

Stalac za ljepljivu traku

- plastični stalak
- sort boje
- s metalnim nožem
- za traku veličine 10/19 mm x 33 m
- pakiranje: 1
- šifra: 000017648



fornax

Stalac za ljepljivu traku

- s ne klizajućom gumenom podlogom
- s metalnim nožem
- za traku veličina: 15/25 mm x 66 m
- boja: sortirano
- pakiranje: 12
- šifra: 000029897



siam

Stalac za ljepljivu traku MT66

- plastični stalak crne boje
- s metalnim nožem
- za traku veličine 19 mm x 66 m
- pakiranje: 1
- šifra: 000006672



CIAC

Stalac za ljepljivu traku

- plastični stalak
- plavo-bijele boje
- s metalnim nožem
- za traku veličine 19 mm x 66 m
- pakiranje: 1
- šifra: 000001367





Ručni držač Economy

- s trakom 48 mm x 50 m gratis
- kvalitetan ručni dispenser za profesionalnu primjenu Tesa traka za pakiranje
- kontrola zatezanja regulira se rukom
- prekriveno sječivo
- pogodna za sve role širine do 50 mm
- pakiranje: 1
- šifra: **000014145**



Ručni držač Economy

- kvalitetan ručni dispenser za profesionalnu primjenu Tesa traka za pakiranje
- kontrola zatezanja regulira se rukom
- prekriveno sječivo
- pogodna za sve role širine do 50 mm
- pakiranje: 1
- šifra: **000012507**



Ručni držač Comfort

- profesionalni ručni dispenser za pakirne trake
- kontrola zatezanja regulira se rukom
- skriveno sječivo
- meka gumirana ručka za udobno, sigurno držanje u ruci
- pogodna za sve role širine do 50 mm
- pakiranje: 1
- šifra: **000012508**

LJEPILA U ROLERU I PEČATU



Ljepilo u roleru

- izuzetno snažno ljepljenje
- čisto, brzo i trajno povezivanje
- lijepi papir, karton, fotografije
- boja pokazuje gdje je ljepilo nanešeno
- osnova otporna na pucanje
- ne sadrži otapala
- dimenzija: 8.4 mm x 8.5 mm
- pakiranje: 10
- šifra: **000015662**



Ljepilo u pečatu

- permanentno
- brz i jednostavan način ljepljenja dokumenata ili fotografija na papir
- veličina ljepljivih jastučića: 8.4x8.4 mm
- duljina trake: 10 mx8.4 mm
- 1100 ljepljivih jastučića
- pakiranje: 1
- šifra: **000031052**



LJEPILA U STIKU



Ljepilo u stiku

- kvalitetno ljepilo u stiku
- lijepi papir, pogodan posebno za učenike
- dolazi u pakiranju od 10, 20 ili 40gr
- pakiranje: display

Šifra	Masa (gr)	Pakiranje
000011449	10	12
000011450	20	12
000011451	40	12



Ljepilo u stiku

- pogodan za papir i karton
- omogućuje brzo i čisto ljepljenje
- ljepilo bez otapala i mirisa
- perivo na 30°
- masa: 10 g
- pakiranje: 24
- šifra: **000029243**



tesa
Ljepilo u stiku

- pogodan za papir, karton, fotografije, tkanine, kožu
- bez mirisa, ne sadrži otapala
- lako se nanosi, čisti se rukom
- praktičan poklopac koji se ne kotrlja
- ambalaža od reciklirane plastike i blister bez PVC-a

Šifra	Masa (gr)	Pakiranje
000015663	10	24
000015664	20	12

UHU
Ljepilo u stiku

- za čisto, brzo i trajno ljepljenje
- čep s navojem čvrsto zatvara stick i sprječava sušenje
- nanosi se ravnomjerno
- čisti se vodom
- ne sadrži otapala

Šifra	Masa (gr)	Pakiranje
000012475	8.2	24
000016816	21	24
000019695	40	24

Henkel
Ljepilo u stiku Pritt

- pogodan za papir, karton, fotografije
- ne sadrži otapala
- 90% ljepljive mase je napravljeno od obnovljivih sastojaka
- ambalaža od 70% reciklirane plastike

Šifra	Masa (gr)	Pakiranje
000026832	10	25
000026833	20	12
000026834	40	10

Connect
Ljepilo u stiku

- bijele boje
- lijepi papir, fotografije i sl.
- čisti se vodom

Šifra	Masa (gr)	Pakiranje
000030226	8	24
000030227	15	24
000030228	21	12
000030229	40	12

tesa
Ljepilo u stiku Easy stick

- pogodan za papir, karton, fotografije, tkanine, kožu
- bez mirisa, ne sadrži otapala
- lako se nanosi, čisti se rukom
- praktičan poklopac koji se ne kotrlja
- ambalaža od reciklirane plastike i blister bez PVC-a

Šifra	Masa (gr)	Pakiranje
000015666	12	24
000015667	25	24

foroffice
Ljepilo u stiku

- lijepi papir, karton i sl.
- ne sadrži otapala

Šifra	Masa (gr)	Pakiranje
000018796	8	24
000018797	15	24
000026319	21	12
000026320	40	24

Red-Bu
Ljepilo u stiku Fluo

- za ljepljenje papira
- 4 atraktivne boje
- masa: 15 gr
- pakiranje: 24
- šifra: 000023984



UHU**Ljepilo Twist & Glue**

- bez otapala
- univerzalno ljepilo u mekoj plastičnoj bočici
- s jedinstvenim sustavom nanošenja
- idealno za ured, školu i dom
- ne gužva papir
- može se oprati na 60°C
- količina: 35ml
- pakiranje: 12
- šifra: **000015322**

**UHU****Ljepilo Twist & Glue**

- s otapalom
- univerzalno ljepilo u mekoj plastičnoj bočici
- s jedinstvenim sustavom nanošenja
- idealno za ured, školu i dom
- ne gužva papir
- može se oprati na 60°C
- količina: 35ml
- pakiranje: 12
- šifra: **000012476**

**Henkel****Ljepilo Pritt**

- pogodan za papir, karton, kožu, drvo, staklo, stiropor ...
- ne sadrži otapala
- 90% napravljen od prirodnih sastojaka
- količina: 50 ml
- pakiranje: 10
- šifra: **000026831**

**tesa****Ljepilo višenamjensko**

- univerzalno ljepilo u bočici
- lijepi papir, fotografije, tkanine, kožu, drvo, metal, staklo, porculan, keramiku
- visoka otpornost na svjetlost, toplinu i starenje
- lijepi velike plohe uz poseban poklopac za nanošenje
- precizno točkasto lijepljenje uz spuštenu poklopac
- masa: 90gr
- pakiranje: 10
- šifra: **080000042**

**UHU****Ljepilo Flex+Clean Kraft**

- univerzalno ljepilo
- blister pakiranje
- jednostavan nanos
- brzo i snažno lijepljenje
- bezbojno
- količina: 20ml
- pakiranje: 10
- šifra: **000019694**

**UHU****Ljepilo univerzalno**

- univerzalno ljepilo u gel obliku
- aluminijska tuba
- osigurava precizno i čisto lijepljenje
- lijepi papir, drvo, karton, keramiku



Šifra	Količina (ml)	Pakiranje
000003316	20	30
000003317	35	10

UHU**Ljepilo Extra gel**

- univerzalno ljepilo u gel obliku
- osigurava precizno i čisto lijepljenje
- ne kaplje, niti vuče niti
- masa: 31gr
- pakiranje: 10
- šifra: **000015321**

**Henkel****Ljepilo Pritt**

- univerzalno ljepilo u gel obliku
- osigurava precizno i čisto lijepljenje
- masa: 35 gr
- pakiranje: 10
- šifra: **000030526**





Connect

Ljepilo

- univerzalno ljepilo
- aluminijska tuba



Šifra	Količina (ml)	Pakiranje
000028786	25	30
000028787	40	20



Ljepilo OHO

- univerzalno ljepilo
- ljepilo za papir
- aluminijska tuba



Šifra	Masa (gr)	Pakiranje
000017548	20	25
000017267	40	25

LJEPILA NAMJENSKA

Henkel

Ljepilo u olovci Pritt

- pogodan za papir, karton, tkaninu, kožu, pluto, drvo i filc
- ne sadrži otapala
- količina: 40 ml
- pakiranje: 12
- šifra: **000026835**



UHU

Ljepilo Glue pen

- tekuće ljepilo u olovci
- za papir i karton
- nanosi se jednostavno i čisto
- ne gužva papir
- čisti se vodom
- ne sadrži otapala
- količina: 50 ml
- pakiranje: 36
- šifra: **000015332**



Connect

Ljepilo Glue pen

- tekuće ljepilo u olovci
- za papir i karton
- brzo se suši
- ne sadrži toksične tvari
- količina: 50 ml
- pakiranje: 12
- šifra: **000028719**



Ljepilo OHO

- tekuće prozirno ljepilo
- idealan za izradu slima/ljigavca
- količina: 220ml
- pakiranje: 25
- šifra: **000033096**



Connect

Ljepilo

- za papir, karton
- aluminijska tuba
- količina: 35 ml
- blister pakiranje
- pakiranje: 16
- šifra: **000030271**



Eurokarbon

Ljepilo Karbofix-S

- ljepilo za papir
- bijele boje
- aluminijska tuba
- masa: 25gr
- pakiranje: 30
- šifra: **000001927**



Connect

Ljepilo u čaši

- ljepilo za papir bijele boje
- plastična čaša s lopaticom
- bio razgradiv
- masa: 100 gr
- pakiranje: 1
- šifra: **000030540**



Eurokarbon

Ljepilo K-Eurofix

- ljepilo za papir bijele boje
- plastična čaša s lopaticom
- masa: 100 gr
- pakiranje: 240
- šifra: **000001065**



UHU**Ljepilo Super Strong & Safe**

- kombinacija univerzalnog i cianoakrilnog ljepila
- snažno, brzo i sigurno omogućava popravke
- ne lijepi prste
- namijenjeno za skoro sve savitljive, tvrde, porozne i neporozne materijale
- masa: 7gr
- pakiranje: 10
- šifra: **000015328**

**LOCTITE****Ljepilo Super Bond Power Flex**

- gel formula sa gumom koja pruža visoku čvrstoću i fleksibilnost, te sprječava kapanje
- nakon sušenja ostaje transparentan
- pogodan za: porculan, metal, gumu, kožu, drvo, plastiku (osim PE/PP) i papir
- podnosi teška opterećenja
- otporan na udarce i vibracije
- masa: 2gr
- pakiranje: 12
- šifra: **000031204**

**tesa****Ljepilo**

- za brze popravke predmeta
- lijepi u samo nekoliko sekundi
- dugo drži, izvrsno postojano u vodi
- izuzetno otporno na hladnoću i toplinu
- idealno za glatke površine
- masa: 4,5gr
- pakiranje: 10
- šifra: **000012495**

**tesa****Ljepilo**

- za brze popravke predmeta
- lijepi u samo nekoliko sekundi
- dugo drži, izvrsno postojano u vodi
- izuzetno otporno na hladnoću i toplinu
- idealno za porozne predmete
- masa: 4,5gr
- pakiranje: 10
- šifra: **000015744**

**UHU****Ljepilo**

- tekuće trenutno ljepilo
- dovoljna je jedna kap
- postiže izuzetne rezultate na tvrdim površinama
- masa: 3gr
- blister pakiranje
- pakiranje: 12
- šifra: **000015338**

**Ljepilo OHO**

- tekuće trenutno ljepilo
- masa: 3gr
- blister pakiranje
- pakiranje: 12
- šifra: **000033097**

**fornax****Ljepilo**

- idealno za porculan, plastiku, metal, drvo, staklo i ostale materijale
- lijepi u samo nekoliko sekundi
- masa: 3gr
- pakiranje: 1
- šifra: **000012731**

**tesa****Ljepilo u spreju Extra strong**

- izuzetno jako ljepilo koje formira tanak sloj za trajno spajanje materijala kao što su tkanina, plastika, karton, pjena, guma, izolirajući materijali, vinil, koža i guma, jedan za drugi ili na metal i drvo
- prikladno za teške materijale s hrapavim i neravnim površinama
- sprej pravi tanak sloj ljepila
- pravac spreja se može podesiti horizontalno ili vertikalno
- podesiva količina spreja (H-visoka, M-serdnja, L-niska)
- otporno na vlagu i temperature od -30°C do +80°C
- ne sadrži silikon
- količina: 500 ml
- pakiranje: 12
- šifra: **000020901**



**Ljepilo u spreju Permanent**

- višenamjensko ljepilo za trajno lijepljenje materijala kao što su papir, karton, filc, tkanina, folija, koža i drugi plastični materijali
- za čisto, ekonomično i brzo spajanje velikih površina
- fino i ravnomjerno nanošenje ljepila
- brzo sušenje
- otporno na vlagu i temperature od -20°C do +60°C

Šifra	Količina (ml)	Pakiranje
080000043	300	12
000020900	500	12



ODSTRANJIVAČ LJEPILA



DOBRO JE ZNATI



Ne ostavlja tragove



Sigurno i pouzdano uklanja ostatke ljepila



Jednostavno odstranjuje samoljepljive naljepnice

**Odstranjivač ljepila**

- u spreju
- za odstranjivanje etiketa, traka
- jednostavno odstranjuje ostatke ljepila sa stakla, plastike, metala
- isparava ne ostavljajući tragove
- bez silikona
- količina 200 ml
- šifra: **000015668**



LJEPILJIVI JASTUČIĆI

**Ljepljivi jastučići Patafix**

- ljepljiva masa za pričvršćivanje postera, crteža i lakših predmeta
- fiksirane stvari je moguće kasnije jednostavno razdvojiti, a masu ponovno koristiti
- masa je bijele ili nježno žute boje
- sadržaj: 80 ljepljivih jastučića
- pakiranje: 12
- šifra: **000015335**

**Ljepljivi jastučići Tack**

- ljepljiva masa za pričvršćivanje postera, crteža i lakših predmeta
- fiksirane stvari je moguće kasnije jednostavno razdvojiti, a masu ponovno koristiti
- masa je bijele boje
- sadržaj: 65 ljepljivih jastučića
- pakiranje: 16
- šifra: **000033612**



3M**Ljepljivi jastučići Scotch**

- ljepljiva masa za pričvršćivanje postera, crteža i lakših predmeta
- fiksirane stvari je moguće kasnije jednostavno razdvojiti, a masu ponovno koristiti
- masa je bijele boje
- sadržaj: 84 ljepljivih jastučića
- pakiranje: 10
- šifra: **000021888**

**Ljepljivi jastučići Tack-it**

- ljepljiva masa za pričvršćivanje postera, crteža i lakših predmeta
- masa je zelene ili bijele boje
- masa: 20 g
- pakiranje: 1
- šifra: **000030848**

**tesa****Ljepljivi jastučići Powerstrips**

- alternativa bušilici i čavlima
- čvrsto držanje predmeta na većini ploha
- drži do 2 kg na glatkim površinama
- odstranjuju se bez ikakvih tragova zahvaljujući powerstrips tehnologiji
- sadržaj: 10 traka
- pakiranje: 15
- šifra: **000022466**

**tesa****Ljepljivi jastučići AutoFix**

- ultra jako držanje
- vrlo dobro prianja na PP, PVC i ABS
- otporni na temp. do +80°C
- visoka otpornost na UV zračenje
- sadržaj: 2x4 cm : 2.8 cm / 2x1.6 cm : 2.8 cm
- boja: crna
- pakiranje: 6
- šifra: **000022533**



ŠTIPALJKE ZA PAPIR

**Štipaljke za papir**

- za jednostavno spajanje papira bez heftanja
- metalne
- raznih veličina

Šifra	* Max. mm	Pakiranje
000027963	15	12
000003978	19	12
000003979	25	12
000006888	32	12
000006889	41	12
000006890	51	12

* Max. mm - označava max. debljinu papira koju štipaljka može obuhvatiti





Spjalice

- služi za spajanje papira
- različitih dimenzija od broja 2 do 5, s tim da su spjalice br. 2 najmanjih dimenzija
- sadržaj kutije: 100 spjalica
- pakiranje: 10

Šifra	Broj spjalice	Dužina spjalice
000001081	2	25 mm
000001079	3	30 mm
000003341	4	32 mm
000001080	5	50 mm



fornax

Spjalice

- niklovane spjalice
- služi za spajanje papira
- idealno za ured, školu...
- različitih dimenzija od broja 2 do 5, s tim da su spjalice br. 2 najmanjih dimenzija
- sadržaj kutije: 100 spjalica
- pakiranje: 10

Šifra	Broj spjalice	Dužina spjalice
000012268	2	25 mm
000012251	3	28 mm
000016174	4	32 mm
000016175	5	46 mm



Spjalice

- služi za spajanje papira
- dužina spjalice 75 mm
- sadržaj kutije: 50 spjalica
- šifra: 000023513



fornax

Spjalice u boji N.2

- služi za spajanje papira
- spjalice raznih boja
- dužina spjalice 25 mm
- blister pakiranje
- sadržaj kutije: 100 spjalica
- šifra: 000012264



Spjalice u boji Br.4

- služi za spajanje papira
- spjalice raznih boja
- dužina spjalice 32 mm
- sadržaj kutije: 60 spjalica
- šifra: 000021484

KUTIJE ZA SPAJALICE



fornax

Kutija magnetna za spjalice ZH-102

- prozirna PVC kutija
- s magnetom u poklopcu kutije
- poklopac u raznim bojama
- sadržaj kutije: 20 spjalica
- dužina spjalice 28 mm
- boja: sortirano
- pakiranje: 12
- šifra: 000012411



fornax

Čaša za spjalice

- žičana okrugla čaša
- dostupna u srebrnoj i crnoj boji
- visina čaše 32 mm
- promjer čaše 95 mm
- pakiranje: 24

- 000014793
- 000014792

Rapid**Heftarica stolna Fashion HD210**

- modernog dizajna
- prigodna za svaki ured
- srebrno/narančaste boje
- pakiranje: 1
- šifra: **000021127**

**Rexel****Heftarica stolna Gladiator**

- elegantan dizajn za veliki volumen spajanja papira
- metalna je i jako čvrsta
- crne boje
- pakiranje: 1
- šifra: **000011216**

**Heftarica stolna Genmes**

- čvrsta metalna konstrukcija
- idealna za spajanje većeg broja listova
- pakiranje: 1
- šifra: **000006660**

**MOLHO LEONE****Heftarica stolna 130**

- konstrukcija je kombinacija metala i plastike
- klasični tip spajanja
- crno/srebrne boje
- pakiranje: 1
- šifra: **000000132**

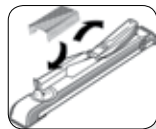
**LEITZ****Heftarica stolna 5560**

- s posebnom tehnologijom za savršeno i lako spajanje
- konstrukcija je kombinacija metala i plastike
- srebrno/crne boje
- pakiranje: 1
- šifra: **000002051**

**Rapid****Heftarica stolna Fashion Eco**

- napravljena od 80% reciklirane plastike
- pakiranje je od recikliranog kartona
- otisak ispisan s tintom na bazi soje
- korišteno ljepilo na bazi vode
- pakiranje: 6
- šifra: **000021150**





Rapid

Heftarica stolna/ručna Supreme Omnipress S060

- čvrsta metalna konstrukcija modernog dizajna
- konstrukcija je kombinacija metala i plastike
- pakiranje: 1
- šifra: **000027711**



Rapid

Heftarica stolna/ručna Supreme Omnipress S030

- čvrsta metalna konstrukcija modernog dizajna
- konstrukcija je kombinacija metala i plastike
- pakiranje: 1
- šifra: **000027710**



REVOLUCIJA U UREDU



Upotreba u ruci



Upotreba na stolu

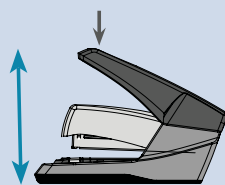

Press Less
tehnologija

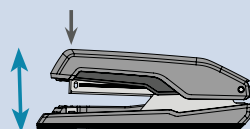

Standardna
tehnologija

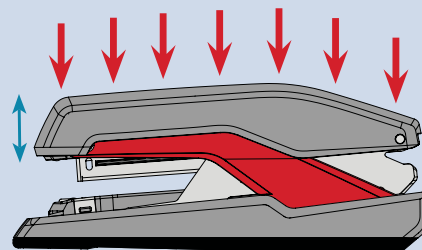

Omnipress tehnologija

Revolucionarna tehnologija Omnipress® znači, da možete pritisnuti bilo gdje na tijelu heftalice, s mnogo manje snage kao kod obične heftalice. A u usporedbi s drugim sličnim heftalicama za upotrebu s manjom snagom ova heftalica dovoljno je mala, da je možete koristiti i u ruci.



LEITZ

Heftarica stolna s deklamericom 5501

- praktična heftarica s deklamericom
- konstrukcija je kombinacija metala i plastike
- dvije vrste spajanja: otvoreno i zatvoreno klinasto
- u pakiranju uključeno i 400 spajalica 26/6
- dostupna u 3 boje
- pakiranje: 12

- 000020806
- 000020807
- 000020811



LEITZ

Heftarica stolna s deklamericom 5502

- praktična heftarica s deklamericom
- konstrukcija je kombinacija metala i plastike
- dvije vrste spajanja: otvoreno i zatvoreno klinasto
- dostupna u crvenoj boji
- pakiranje: 1
- šifra: 000020808



OBJAŠNJENJE IKONA



- broj listova papira koliko heftarica može spojiti



- koju municiju heftarica koristi



- načini spajanja



- dubina grla

LEITZ

Heftarica stolna s deklamericom 5502 metallic

- praktična heftarica s deklamericom
- konstrukcija je kombinacija metala i plastike
- dvije vrste spajanja: otvoreno i zatvoreno klinasto
- dostupna u 5 metalik boja
- pakiranje: 1

- 000021134
- 000021137
- 000021136
- 000021135



ReXel**Heftarica Joy Gazelle**

- ergonomski oblikovana s mekanim gripom
- u svakom trenutku može se vidjeti koliko municije ima u heftarici
- dostupna u plavoj i ljubičastoj boji
- pakiranje: 1

■ • 000028055

■ • 000028054

**lebez****Heftarica stolna 589**

- metalne konstrukcije
- dostupna u zeleno/crnoj boji
- pakiranje: 1
- šifra: 000005543

**LEITZ****Heftarica stolna mini 5517**

- ergonomski oblikovana
- konstrukcija je kombinacija metala i plastike
- dostupna u 3 boje
- pakiranje: 12

■ • 000011001

■ • 000010809

■ • 000010810



HEFTARICE ELEKTRIČNE

LEITZ**Heftarica stolna električna**

- električna heftarica za spajanje velikog broja listova papira
- konstrukcija je kombinacija metala i plastike
- plave boje
- puni se pomoću adaptera ili baterija (6xAA)
- pakiranje: 1
- šifra: 000002140



Rapid
Heftarica ručna Classic K1

- čvrsta metalna konstrukcija
- srebrne boje
- pakiranje: 1
- šifra: **000022562**

LEITZ
Heftarica ručna 5549

- metalna konstrukcija s ergonomski oblikovanim ručkama
- dvije vrste spajanja: otvoreno i zatvoreno klinasto
- srebrne boje
- pakiranje: 5
- šifra: **000003212**

Rexel
Heftarica ručna R56

- metalna konstrukcija
- klasični tip spajanja
- koristi municiju 24/6 i 26/6 (za spajanje 20 listova) ili 24/8 i 26/8 (za spajanje 40 listova)
- pakiranje: 6
- šifra: **000028626**

fornax
Heftarica ručna

- metalna konstrukcija
- srebrne boje
- blister pakiranje
- pakiranje: 12
- šifra: **000018799**

fornax
Heftarica ručna S12 502

- metalna konstrukcija
- dostupna u raznim bojama: srebrna, zelena, roza, plava i metalna
- pakiranje: 12
- šifra: **000012266**

ro-ma
Heftarica ručna Primula 12

- metalna konstrukcija
- srebrne boje
- pakiranje: 1
- šifra: **000003733**





Heftarica ručna

- metalna
- crno/srebrne boje
- pakiranje: 1
- šifra: **000025688**



Heftarica ručna 638

- metalna konstrukcija
- dvije vrste spajanja: otvoreno i zatvoreno klinasto
- srebrne boje
- pakiranje: 1
- šifra: **000009451**



EKOLOŠKI PROIZVODI



Heftarice napravljene od 80% reciklirane plastike.

Pakiranje napravljeno od recikliranog kartona, ispisano s tintom na bazi soje i ljepljeno s ljepljivom na bazi vode.

Spoj modernog dizajna i ekološkog proizvoda idealan za svaki ured.



- tinta na bazi soje



- reciklirani karton



- dizajnirano za jednostavno rastavljanje



Heftarica ručna Fashion Eco

- napravljena od 80 % reciklirane plastike
- pakiranje je od recikliranog kartona
- otisak ispisano s tintom na bazi soje
- korišteno ljepljivo na bazi vode
- pakiranje: 6
- šifra: **000021149**



Heftarica ručna Basic 1

- klasični tip spajanja
- metalna konstrukcija
- crvene boje
- pakiranje: 1
- šifra: **000000537**



**Heftarica ručna 645**

- klasični tip spajanja
- metalna konstrukcija
- crne boje
- pakiranje: 1
- šifra: **00000543**

**Heftarica ručna 646**

- klasični tip spajanja
- metalna konstrukcija
- srebrne boje
- pakiranje: 1
- šifra: **00000539**

**Heftarica ručna 5547 metallic**

- metalna konstrukcija s ergonomski oblikovanim ručkama
- dostupna u više boji
- u pakiranje uključeno i 1000 spajalica No.8
- pakiranje: 5

- 000003213
- 000021142
- 000021143
- 000021140
- 000021141
- 000001754
- 000021139

**Heftarica**

- u obliku štikle
- crvene i crne boje
- pakiranje: 1

- 000028059
- 000028058



**fornax****Heftarica ručna**

- metalna konstrukcija
- klasični tip spajanja
- boja: sortirano
- blister pakiranje
- pakiranje: 12
- šifra: **000018798**

**Heftarica ručna Primula 6**

- ručna heftarica
- metalna konstrukcija
- pakiranje: 1
- šifra: **000003669**

**Heftarica ručna mini Green Logic**

- napravljena od 90% reciklirane plastike
- dostupna u crnoj boji
- pakiranje: 20
- šifra: **000028673**

**Rapid****Heftarica ručna mini Fashion Eco**

- napravljena od 80% reciklirane plastike
- pakiranje je od recikliranog kartona
- otisak ispisan s tintom na bazi soje
- korišteno ljepilo na bazi vode
- dostupna u crnoj boji
- pakiranje: 12
- šifra: **000021151**

**Rexel****Heftarica ručna Beasti**

- malih dimenzija
- s gumiranom podlogom
- sadrži integrirani odstranjivač spajalica
- fluorescentne boje
- pakiranje: 10
- šifra: **000010664**

**Heftarica ručna tapetarska 4-10**

- za tapete
- od fiberglasa
- pakiranje: 1
- šifra: **000023224**



**Deklamerica KS-405**

- uklanja sve vrste spajalica
- u obliku kliješta
- metalna konstrukcija
- blister pakiranje
- pakiranje: 12
- šifra: **000012267**

**Deklamerica**

- uklanja sve vrste spajalica
- u obliku kliješta
- metalna konstrukcija
- pakiranje: 12
- šifra: **000009041**

**Deklamerica HL8101**

- uklanja sve vrste spajalica
- male dimenzije
- pakiranje: 12
- šifra: **000012248**

MUNICIJA ZA HEFTARICU

**Municija za heftaricu**

- kvalitetne spajalice za heftaricu
- raznih veličina



Šifra	Oznaka	Br. spajalica u paketu	Pakiranje
000015973	23/6 (No.23)	1000	10
000015974	23/8 (No.23)	1000	10
000015975	23/10 (No.23)	1000	10
000015976	23/13 (No.23)	1000	10
000015977	23/17 (No.23)	1000	10
000015978	23/20 (No.23)	1000	10
000010668	No.10	1000	20
000010669	24/6 (No.16)	1000	20
000018688	26/6 (No.56)	1000	20
000010667	48/64 (No.25)	1000	20

**Municija za heftaricu Super strong**

- napravljene od jako čvrstog željeza
- spajaju 50 listova i više
- namjenjene za heftaricu stolnu Fashion HD210

Šifra	Oznaka	Br. spajalica u paketu	Pakiranje
000021128	9/10	1000	5
000021129	9/12	1000	5
000021130	9/17	1000	5
000021131	9/24	1000	5
000023111	24/8	1000	5

**Municija za heftaricu**

- vrhunska Rexel kvaliteta
- oznaka: 26/6
- dostupne u plavoj i ljubičastoj boji
- pakiranje: 2000/1

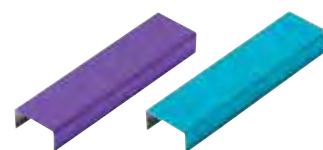

- **000028057**
- **000028056**

**Municija za heftaricu Strong**

- oštri rubovi za čvršće spajanje
- oznaka: 24/6
- spajaju 30 listova
- broj spajalica u paketu: 1000
- pakiranje: 5
- šifra: **000023110**

**Municija za heftaricu Standard**

- oznaka: 24/6
- spajaju 20 listova
- broj spajalica u paketu: 1000
- pakiranje: 5
- šifra: **000023109**



DIMENZIJE OZNAKA MUNICIJE ZA HEFTARICE

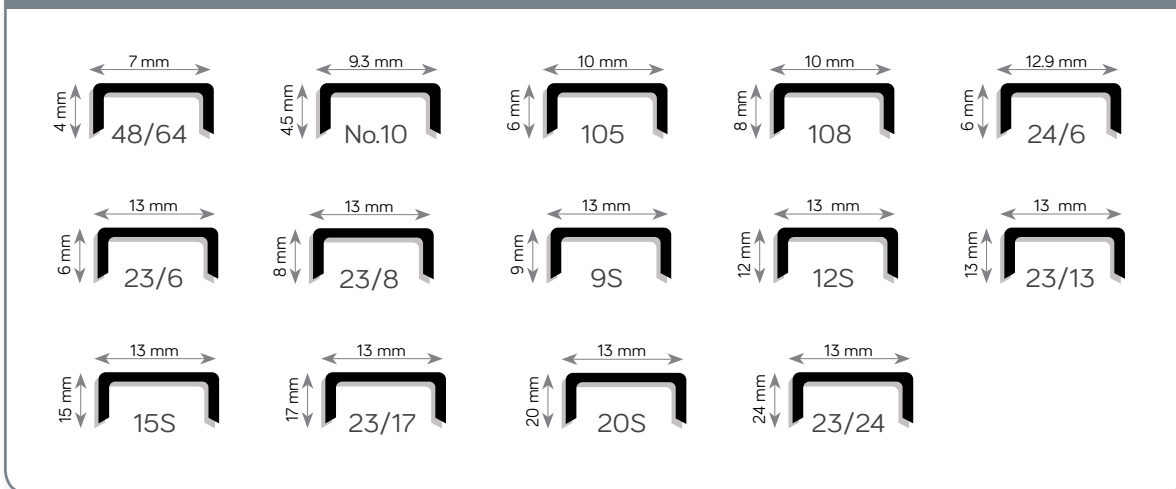

Municija za heftaricu Standard

- oznaka: 21/4 (48/64)
- spajaju 12 listova
- broj spajalica u paketu: 1000
- pakiranje: 5
- šifra: 000026888



Municija za heftaricu

- za heftaricu Supreme Omnipress 30
- spajaju 30 listova
- broj spajalica u paketu: 1000
- pakiranje: 5
- šifra: 000030358



Municija za heftaricu

- za heftaricu Supreme Omnipress 60
- spajaju 60 listova
- broj spajalica u paketu: 1000
- pakiranje: 5
- šifra: 000030156



Municija za heftaricu

- metalne spajalice
- univerzalne

Šifra	Oznaka	Br. spajalica u paketu	Pakiranje
000023506	23/8	1000	10
000023507	23/10	1000	10
000023508	23/13	1000	10
000023509	23/15	1000	10
000023510	23/17	1000	10
000023511	24/6	1000	10
000023512	24/8	1000	10



Municija za heftaricu

- metalne spajalice
- univerzalne

Šifra	Oznaka	Br. spajalica u paketu	Pakiranje
000000492	S9	1000	60
000000493	S12	1000	50
000000506	S15	1000	46
000024896	S17	1000	1



centra

Municija za heftaricu

- oznaka: 24/6
- spajalica u paketu: 1000
- pakiranje: 20
- šifra: **000021176**



LEITZ

Municija za heftaricu

- oznaka: 24/6
- spajalica u paketu: 1000
- pakiranje: 100
- šifra: **000014422**



Maped

Municija za heftaricu

- oznaka: No.10
- spajalica u paketu: 1000
- pakiranje: 36
- šifra: **000019226**



fornax

Municija za heftaricu

- metalne spajalice
- oznaka: 24/6 i 48/64
- pakiranje: 10

Šifra	Oznaka	Br. spajalica u paketu
000016171	24/6	1000
000016173	48/64	1000



MOLHO LEONE

Municija za heftaricu

- metalne spajalice
- univerzalne
- oznaka: 24/6
- spajalica u paketu: 1000
- pakiranje: 10
- šifra: **000001062**



ro-ma

Municija za tapetarsku heftaricu

- metalne spajalice
- pakiranje: 1

Šifra	Oznaka	Br. spajalica u paketu
000001086	105	5000
000001126	108	5000



Red in Blue

Municija za heftaricu

- metalne spajalice
- oznaka: 48/64
- spajalica u paketu: 1000
- pakiranje: 10
- šifra: **000004306**

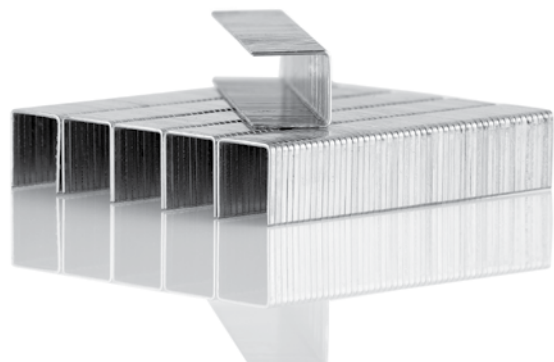



Rapid

Bušilica za papir Supreme HDC150/4

- 4 rupe
- ergonomski oblikovana ručka
- metalni graničnik
- sive boje
- može bušiti: A4, A5 i A6
- pakiranje: 1
- šifra: **000021133**



LEITZ

Bušilica za papir 5132

- 4 rupe
- sive boje
- može bušiti: A4, A5 i A6
- pakiranje: 1
- šifra: **000009881**



LEITZ

Bušilica za papir AKTO

- 1-6 rupa
- s podesivim razmakom između rupa
- srebrene boje
- može bušiti: A2, A3, A4, A5 i A6
- pakiranje: 1
- šifra: **000011675**





OBJAŠNJENJE IKONA



- broj listova papira koliko bušilica može bušiti



- format papira koji bušilica papira može bušiti



- razmak rupa kod bušilica za papir



- promjer rupe koju bušilica za papir izbuši



Bušilica za papir E4001

- 4 rupe
- dostupna u crnoj boji
- može bušiti: A4, A5 i A6
- pakiranje: 1
- šifra: **000028901**



BUŠILICE ZA PAPIR S 2 RUPE



Bušilica za papir HD2300

- 2 rupe
- metalna konstrukcija
- metalni graničnik
- crne boje
- može bušiti: B3, B4, B5, B6, A3, A4, A5 i A6
- pakiranje: 1
- šifra: **000019838**

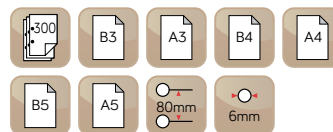

Bušilica za papir HD2150

- 2 rupe
- metalna konstrukcija
- metalni graničnik
- srebrne boje
- može bušiti: B4, B5, B6, A4, A5 i A6
- pakiranje: 1
- šifra: **000018802**



Rapid

Bušilica za papir Supreme HDC150

- 2 rupe
- ergonomski oblikovana ručka
- metalni graničnik
- sive boje
- može bušiti: A4, A5 i A6
- pakiranje: 1
- šifra: **000021132**



fornax

Bušilica za papir

- 2 rupe
- spremnik za otpadni papir
- crne boje
- može bušiti: 150 listova
- pakiranje: 1
- šifra: **000028614**



ReXel

Bušilica za papir P265

- 2 rupe
- konstrukcija presvučena čelikom
- crno/srebrne boje
- može bušiti: A4, B5, A5, B6 i A6
- pakiranje: 1
- šifra: **000010913**



LEITZ

Bušilica za papir 5180

- 2 rupe
- dostupna u 2 boje
- može bušiti: A3, A4, A5 i A6
- pakiranje: 1

• 000007809

• 000004387



fornax

Bušilica za papir

- 2 rupe
- spremnik za otpadni papir
- graničnik za formate papira
- crne i plave boje
- može bušiti: A4, A5 i A6
- pakiranje: 12

• 000031006

• 000031005



Bušilica za papir Essentials

- 2 rupe
- spremnik za otpadni papir
- crne boje
- može bušiti: A4, A5 i A6
- pakiranje: 5
- šifra: 000028241



ReXel

Bušilica za papir V260

- 2 rupe
- spremnik za otpadni papir
- crne boje
- može bušiti: A4, A5 i A6
- pakiranje: 5
- šifra: 000028625



fornax

Bušilica za papir

- 2 rupe
- spremnik za otpadni papir
- crne boje
- može bušiti: A4, A5 i A6
- pakiranje: 1
- šifra: 000031071



LEITZ

Bušilica za papir 5138

- 2 rupe
- dostupna u 2 boje
- materijal: presani čelik
- može bušiti: A4, A5 i A6
- pakiranje: 1

• 000005796

• 000002808



centra

Bušilica za papir HP40

- 2 rupe
- crne boje
- može bušiti: A4, A5 i A6
- pakiranje: 1
- šifra: 000021175





Bušilice su prikladne za svaki ured. Svojom dizajnom omogućuju da Vaš ured izgleda moderno. U našoj ponudi imamo bušilice koje buše četiri rupe i bušilice koje buše dvije rupe. Dijametar bušenja je cca. 5,5 mm, razmak bušenja između dvije rupe je 8 cm. Tako da svaki probušeni papir možete arhivirati u registratoru ili fascikle koji imaju mehanizam za ulaganje papira.

fornax

Bušilica za papir

- 2 rupe
- sadrži spremnik za otpadni papir
- dostupna u 3 boje
- buši debljinu papira do 4 mm
- može bušiti: A4, A5 i A6
- pakiranje: 12

- 000019651
- 000019652
- 000019650



fornax

Bušilica za papir

- 2 rupe
- spremnik za otpadni papir
- dostupna u 3 boje
- buši debljinu papira do 3 mm
- može bušiti: A4, A5 i A6
- pakiranje: 12

- 000019648
- 000019649
- 000019647



centra

Bušilica za papir HP30

- 2 rupe
- dostupna u više boja
- može bušiti: A4, A5 i A6
- pakiranje: 1

- 000021173
- 000021172



LEITZ

Bušilica za papir 5008

- 2 rupe
- materijal je od presanog čelika
- dostupna u više boja
- može bušiti: A4, A5 i A6
- pakiranje: 1

- 000010811
- 000010812
- 000010814
- 000010813

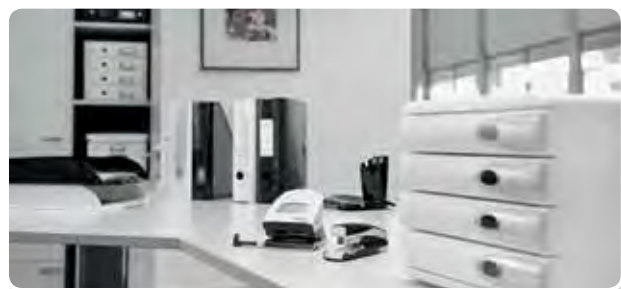



Bušilica za papir 5008 metalic

- 2 rupe
- materijal je od presanog čelika
- modernog dizajna i sjajnih boja
- dostupna u više metalik boja
- može bušiti: A4, A5 i A6
- pakiranje: 1

- 000021144
- 000021148
- 000021146
- 000021145



Bušilica za papir Fashion Eco20

- 2 rupe
- napravljena od 80% reciklirane plastike
- pakiranje je od recikliranog kartona
- otisak ispisan s tintom na bazi soje
- korišteno ljepilo na bazi vode
- može bušiti: A4, A5 i A6
- pakiranje: 1
- šifra: 000021152



Bušilica za papir HP20

- 2 rupe
- dostupna u 2 boje
- može bušiti: A4, A5 i A6
- pakiranje: 1

- 000021171
- 000021170

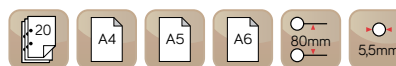

Bušilica za papir

- 2 rupe
- spremnik za otpadni papir
- dostupna u 3 boje
- buši: 20 listova
- pakiranje: 12

- 000019645
- 000019646
- 000019644



ReXel

Bušilica za papir P215

- 2 rupe
- elegantni dizajn, s indikatorom pravilnog bušenja
- dostupna u 2 boje
- može bušiti: A4, B5, A5, B6 i A6
- pakiranje: 10

• 000010674

• 000010673

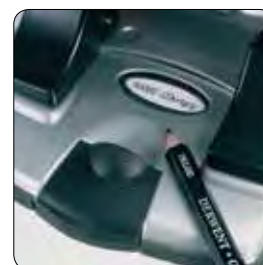

MOLHO LEONE

Bušilica za papir 76072

- 2 rupe
- metalna konstrukcija
- plave boje
- buši debljinu papira do 1.5 mm
- može bušiti: A4, A5 i A6
- pakiranje: 1
- šifra: 000000187



fornax

Bušilica za papir

- 2 rupe
- spremnik za otpadni papir
- dostupna u 3 boje
- buši: 10 listova
- pakiranje: 12

• 000019642

• 000019643

• 000019641



Bušilica za papir Genmes

- 1 rupa
- metalna konstrukcija
- sort boje
- buši sve formate papira
- pakiranje: 1
- šifra: 000006678



lebez

Bušilica za papir

- 1 rupa
- metalna konstrukcija
- gumene ručke
- blister pakiranje
- pakiranje: 1
- šifra: 000028261



fornax**Skalpel**

- plastična konstrukcija
- PVC vodilica
- s mogućnošću izmjene noževa
- širina noža većeg skalpela je 18 mm, a manjeg 9 mm
- pakiranje: 24

9mm • 000021486

18mm • 000021487

**Skalpel**

- plastična konstrukcija i vodilica
- mogućnost izmjene noževa
- dostupan u dvije dimenzije
- širina noža većeg skalpela je 18 mm, a manjeg 9 mm
- pakiranje: 10

9mm • 000018190

18mm • 000018191

**Skalpel**

- plastična konstrukcija
- PVC vodilica
- s mogućnošću izmjene noževa
- širina noža većeg skalpela je 18 mm, a manjeg 9 mm
- pakiranje: 24 (9 mm), 12 (18 mm)

9mm • 000024067

18mm • 000024068

**lebez****Skalpel**

- plastična konstrukcija i vodilica
- širina noža je 18 mm
- sort boje
- pakiranje: 24
- šifra: 000032848

**Skalpel SK10**

- plastična konstrukcija
- metalna vodilica
- siguran za rukovanje
- omogućuje 4 razine rezanja
- reže: foliju, kožu, najlon, plastiku...
- pakiranje: 6
- šifra: 000023717

**Skalpel L/1 i 180**

- plastična konstrukcija
- metalna vodilica
- s rotirajućim mehanizmom
- mogućnost izmjene noževa
- dostupan u dvije dimenzije
- širina noža većeg skalpela je 18 mm, a manjeg 9 mm
- pakiranje: 6

9mm • 000009073

18mm • 000002649



OLFA®**Skalpel L5-AL**

- profesionalni skalpel
- ComfortGrip rukohvat ojačan staklenim vlaknima sprječava klizanje
- sastoji od čelične vodilice oštrice, mehanizma automatskog fiksiranja oštrice
- automatska kočnica omogućava brzo i sigurno obavljanje svakodnevnih poslova
- širina noža je 18 mm
- reže: kožu, gumu, konop, staklena vlakna, acetatna vlakna
- primjeri: probijanje gipsa, otvaranje kutija sa bojom, lomljenje rubova, otvaranje kartonskih kutija
- pakiranje: 6
- šifra: **000032832**

**OLFA®****Skalpel SAC-1**

- metalna konstrukcija
- metalna klipisa
- metalna vodilica
- širina noža je 9 mm
- debljina oštrice: 0,38 mm
- kut noža 30°, idealan za male i precizne rezove
- reže: papir, karton i mekano drvo
- pakiranje: 6
- šifra: **000032833**

**OLFA®****Skalpel SPC-1**

- plastična konstrukcija
- širina noža je 9 mm
- reže: papir, karton, foliju i pjenaste ploče
- pakiranje: 40
- šifra: **000032834**

**OLFA®****Nož za skalpel LBB-10**

- za skalpel L5-AL
- kvalitetni nož
- 25% oštrij od ostalih noževa
- širina noža: 18 mm
- debljina oštrice: 0,5 mm
- u praktičnoj PVC kutiji
- blister pakiranje: 10/1
- pakiranje: 6
- šifra: **000032835**

**OLFA®****Nož za skalpel SAB-10**

- za skalpel SAC-1
- kvalitetni nož
- kut noža 30°
- širina noža: 18 mm
- debljina oštrice: 0,38 mm
- u praktičnoj PVC kutiji
- blister pakiranje: 10/1
- pakiranje: 10
- šifra: **000032836**

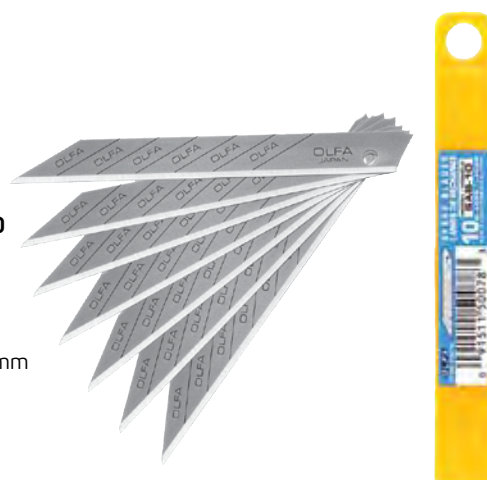

NOŽEVI ZA SKALPELE I POŠTU



Nož za skalpel

- kvalitetni nož
- 10/1
- dostupan u dvije veličine
- 18 mm i 9 mm
- pakiranje: 20

9mm • 000009037

18mm • 000009038



Nož za skalpel

- kvalitetni nož
- u praktičnoj PVC kutiji
- dostupan u dvije veličine
- 18 mm i 9 mm
- blister pakiranje; 10/1
- pakiranje: 6

9mm • 000012465

18mm • 000012466



Nož za poštu

- metalni nož
- dužina: 23 cm
- blister pakiranje
- pakiranje: 12
- šifra: 000023502



ŠKARE



Škare 6100

- uredske škare
- dužine 26 cm
- PVC ručka
- blister pakiranje
- pakiranje: 10
- šifra: 000005336



Škare

- uredske škare
- dužine 25 cm
- PVC ručka
- blister pakiranje
- pakiranje: 12
- šifra: 000009035

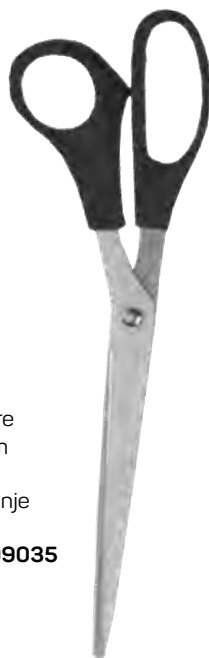

Škare

- uredske škare
- dužine 25 cm
- PVC ručka sa mekanim gripom
- blister pakiranje
- pakiranje: 12
- šifra: 000017587



Škare

- uredske škare
- dužine 25 cm
- PVC ručka
- blister pakiranje
- pakiranje: 12
- šifra: 000027284



Škare

- uredske škare
- dužine 25 cm
- od visoko kvalitetnog nehrđajućeg čelika
- s plastičnim rukohvatom
- blister pakiranje
- pakiranje: 12
- šifra: 000031031





Škare 77324

- uredske škare
- dužine 24 cm
- PVC ručka
- blister pakiranje
- pakiranje: 12
- šifra: **000001592**



Škare

- uredske škare
- dužine 23 cm
- PVC ručka
- blister pakiranje
- pakiranje: 12
- šifra: **000023505**



fornax

Škare

- uredske škare
- dužine 21,5 cm
- od visoko kvalitetnog nehrđajućeg čelika
- s plastičnim rukohvatom
- blister pakiranje
- pakiranje: 12
- šifra: **000030896**



Škare

- uredske škare
- dužine 21 cm
- PVC ručka
- pakiranje: 12
- blister pakiranje
- šifra: **000009034**



Škare 77321

- uredske škare
- dužine 21 cm
- PVC ručka
- blister pakiranje
- pakiranje: 12
- šifra: **000001591**



Škare

- uredske škare
- dužine 21 cm
- PVC ručka
- blister pakiranje
- pakiranje: 12
- šifra: **000023504**



Škare 4331

- uredske škare
- dužine 21 cm
- PVC ručka
- blister pakiranje
- pakiranje: 12
- šifra: **000001056**



foroffice

Škare

- uredske škare
- dužine 20,5 cm
- PVC ručka
- blister pakiranje
- pakiranje: 12
- šifra: **000027283**



fornax

Škare

- za ured i školu
- dužine 19 cm
- PVC ručka
- blister pakiranje
- pakiranje: 12
- šifra: **000019639**



ŠKARE



Škare

- uredske škare
- dužine 19 cm
- PVC ručka
- blister pakiranje
- pakiranje: 12
- šifra: **000023503**



ReXel

Škare Titanium

- za ured i školu
- PVC ručka sa mekanim gripom
- kvalitetne oštrice izrađene od titana
- zaobljen vrh
- dužine 18 cm
- blister pakiranje
- pakiranje: 10
- šifra: **000028065**



ReXel

Škare NonStick

- za ured i školu
- od nehrđajućeg čelika i iznimno kvalitetna oštrica
- pogodne za rezanje ljepljivih i prijanjajućih materijala
- zaobljen vrh
- dužine 18 cm
- blister pakiranje
- pakiranje: 10



• 000028064

• 000028063



foroffice

Škare

- za ured i školu
- dužine 18 cm
- PVC ručka
- blister pakiranje
- pakiranje: 1
- šifra: **000027282**



Škare 965 17 NBK

- za ured, školu i kuću
- dužine 17 cm
- PVC ručka
- blister pakiranje
- pakiranje: 10
- šifra: **000011278**



foroffice

Škare

- za ured i školu
- dužine 16 cm
- PVC ručka
- blister pakiranje
- pakiranje: 1
- šifra: **000025101**



Škare 965 14 NBK

- male škare prikladne za djecu i učenike
- dužine 14 cm
- PVC ručka
- blister pakiranje
- pakiranje: 10
- šifra: **000011277**





Škare 965 14 LNBK

- male škare prikladne za ljevake
- dužine 14 cm
- PVC ručka
- blister pakiranje
- pakiranje: 10
- šifra: **000017508**



Connect

Škare

- školske škare s mjerilom i zaštitom
- obli vrh
- dužine 13 cm
- PVC ručka
- boja: sortirano
- display pakiranje
- pakiranje: 12
- šifra: **000029439**



Škare Heyda Soft touch

- iznimno lako rezanje
- dužine 13 cm
- namjenjene za učenike
- PVC ručka s mekanim gripom
- s naljepnicom za personalizaciju
- blister pakiranje
- pakiranje: 12
- šifra: **000019821**



Connect

Škare

- školske škare s mjerilom
- obli vrh
- dužine 13 cm
- PVC ručka
- boja: sortirano
- display pakiranje
- pakiranje: 12
- šifra: **000029441**



Škare

- školske škare
- obli vrh
- dužine 13 cm
- PVC ručka
- boja: sortirano
- display pakiranje
- pakiranje: 12
- šifra: **000029438**



Škare

- školske škare prikladne za djecu i učenike
- dužine 12 cm
- PVC ručka, sort boje
- display pakiranje: 24
- šifra: **000027967**





OBJAŠNJENJE IKONA



- broj listova koliko rezač papira može rezati



- 3 funkcije



- ravno rezanje



- isprekidano rezanje (perforacija)



- format papira koji rezač papira može rezati



- 4 funkcije



- valovito rezanje



- biganje (presavijanje)

DAHLE

Rezač papira

- profesionalni rezač
- format A0
- max reže 6 listova
- dužina reza 1300 mm
- veličina podloge 1495mm x 360mm
- nož je zatvoren što omogućava veću razinu sigurnosti pri rezanju
- podloga označena u cm i DIN
- može se montirati na zid
- pakiranje: 1
- šifra: **000018507**

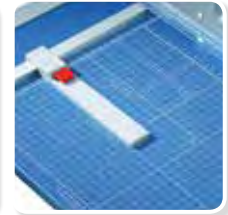
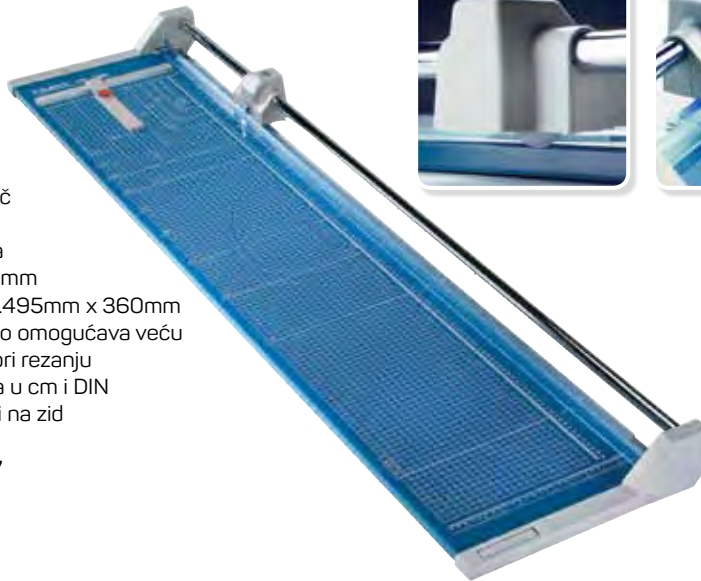

Rexel

Rezač papira SmartCut A535 3 u 1

- omogućuje 3 funkcije
- ravno rezanje, perforacija i biganje
- idealan je za pozivnice, čestitke, vizit kartice, fotografije, naljepnice, dokumente
- čvrsta metalna podloga s tankim linijama omogućava precizno rezanje papira
- kapacitet rezanja: do 30 listova (80g/m²)
- podesiv za formate: A2, A3, A4, A5 i A6
- pakiranje: 1
- šifra: **000010555**

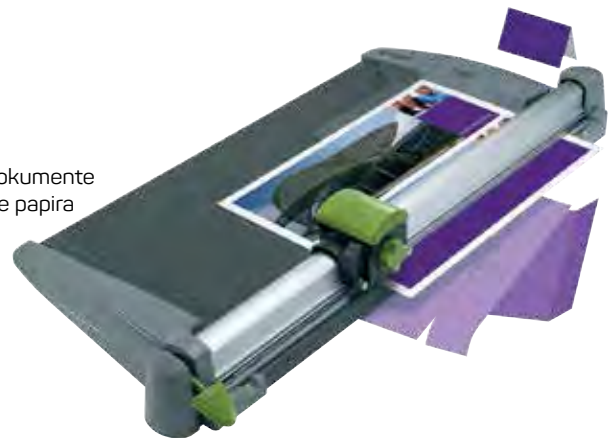

Fellowes

Rezač papira Plasma A3

- ugrađena SafeCut prozirna prepreka
- metalna baza s protukliznim nožicama
- oštrica izrađena od nehrđajućeg čelika
- kapacitet rezanja: do 40 listova (80g/m²)
- podesiv za formate A3, A4, A5 i A6
- pakiranje: 1
- šifra: **000021647**



Sigurnosna barijera montirana i sklopiva, sprječava korištenje giljotine.



Podesivi bočni vodič za precizno ponavljanje rezanja.

ReXel

Rezač papira ClassicCut CL420

- lasersko označavanje reza za veću preciznost
- podloga s tankim linijama omogućava precizno rezanje papira
- ergonomski oblik ručke s nožem
- sigurnosno kočenje noža
- kapacitet rezanja: do 26 listova (80g/m²)
- podesiv za formate A3, A4, A5 i A6
- pakiranje: 1
- šifra: **00000942**

**Fellowes****Rezač papira Gamma A3**

- sječivo od nehrđajućeg čelika olakšava čist i precizan rez
- metalna baza s vodičem za rezanje i nožicama protiv klizanja
- proziran i podesivi vodič za nož na pritisak za lakše poravnavanje dokumenata i precizan rez
- kapacitet rezanja: do 20 listova (80g/m²)
- podesiv za formate A3, A4, A5 i A6
- pakiranje: 1
- šifra: **000024819**



Potpuno oklopljene oštrice osiguravaju maksimalnu razinu zaštite.



Podesivi bočni vodič za precizno ponavljanje rezanja.

Fellowes**Rezač papira Stellar A3**

- ugrađena SafeCut prozirna prepreka
- metalna baza s protukliznim nožicama
- oštrica izrađena od nehrđajućeg čelika
- kapacitet rezanja: do 20 listova (80g/m²)
- podesiv za formate A3, A4, A5 i A6
- pakiranje: 1
- šifra: **000024822**

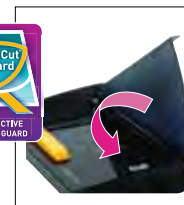

Sigurnosna barijera montirana i sklopiva, sprječava korištenje giljotine.



Podesivi bočni vodič za precizno ponavljanje rezanja.

ReXel

Rezač papira ClassicCut CL120

- plastična podloga s tankim linijama omogućava precizno rezanje papira
- ergonomski oblik ručke s nožem
- kapacitet rezanja: do 10 listova (80g/m²)
- podesiv za formate: A3 i A4
- pakiranje: 1
- šifra: **000000941**



ReXel

Rezač papira SmartCut A445 4 u 1

- omogućuje 4 funkcije
- ravno rezanje, perforacija, biganje i valovito rezanje
- idealan je za pozivnice, čestitke, vizit kartice, fotografije, naljepnice, dokumente
- podloga s tankim linijama, što omogućava precizno rezanje papira
- transparentno ravnalo omogućuje čvrsto držanje papira za vrijeme rezanja
- kapacitet rezanja: do 10 listova (80g/m²)
- podesiv za formate A3, A4, A5 i A6
- pakiranje: 1
- šifra: **000000525**

**Fellowes****Rezač papira Fusion A3**

- ugrađena SafeCut prozirna prepreka
- metalna baza s protukliznim nožicama
- oštrica izrađena od nehrđajućeg čelika
- kapacitet rezanja: do 10 listova (80g/m²)
- podesiv za formate A3, A4, A5 i A6
- pakiranje: 1
- šifra: **000024821**



Sigurnosna barijera montirana i sklopiva, sprječava korištenje giljotine.

Rezač papira Astro A4

- snažni giljotinski samooštreni nož od masivnog čelika Solingen za rezanje većih količina papira, kartona i plastike
- bočni čep podesiv za rezove između 1 i 10 mm za savršeno usklađivanje rada
- ručna preša za pritisnuti papir
- zaštitna barijera od čvrste plastike
- metalna baza za rezanje sa vodičem u raznim formatima
- kapacitet rezanja: do 50 listova (80g/m²)
- podesiv za formate A4, A5 i A6
- pakiranje: 1
- šifra: **000024496**



ReXel

Rezač papira ClassicCut CL710

- čvrsta metalna konstrukcija visoke kvalitete
- vodilice papira za format A4, A5, A6, A7 u milimetrima i inčima
- omogućava precizno rezanje papira
- kapacitet rezanja: do 50 listova (80g/m²)
- za format A4
- pakiranje: 1
- šifra: **000025319**



Fellowes**Rezač papira Gamma A4**

- sječivo od nehrđajućeg čelika olakšava čist i precizan rez
- metalna baza s vodičem za rezanje i nožicama protiv klizanja
- proziran i podesivi vodič za nož na pritisak za lakše poravnavanje dokumenata i precizan rez
- kapacitet rezanja: do 20 listova (80g/m²)
- podesiv za formate A4, A5 i A6
- pakiranje: 1
- šifra: **000024818**



Potpuno oklopljene oštrice osiguravaju maksimalnu razinu zaštite.



Podesivi bočni vodič za precizno ponavljanje rezanja.

**ReXel****Rezač papira ClassicCut CL200**

- čvrsta, stabilna podloga s tankim linijama omogućava precizno rezanje papira
- ergonomski oblik ručke s nožem
- sigurnosno kočenje noža
- kapacitet rezanja: do 15 listova (80g/m²)
- za format A4
- pakiranje: 1
- šifra: **000010471**

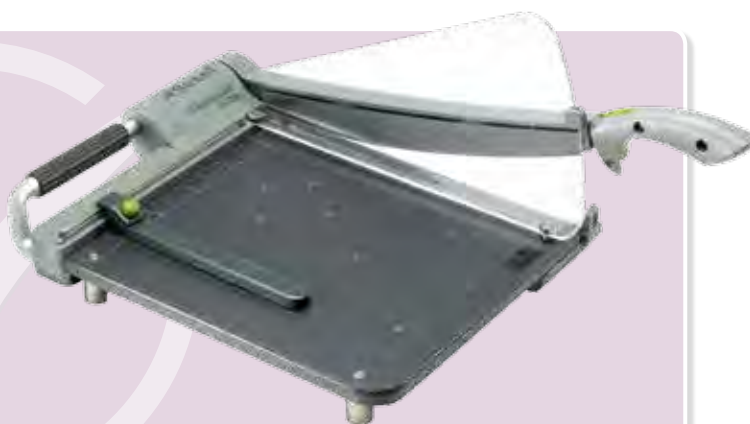
**Fellowes****Rezač papira Fusion A4**

- ugrađena SafeCut prozirna prepreka
- metalna baza s protukliznim nožicama
- oštrica izrađena od nehrđajućeg čelika
- kapacitet rezanja: do 10 listova (80g/m²)
- podesiv za formate A4, A5 i A6
- pakiranje: 1
- šifra: **000024820**

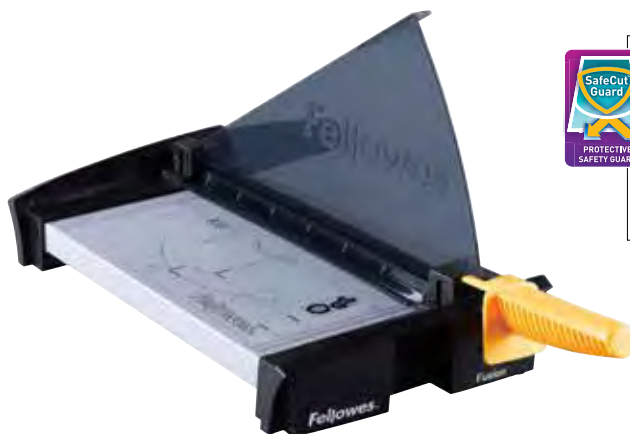

Sigurnosna barijera montirana i sklopiva, sprječava korištenje giljotine.

ReXel**Rezač papira ClassicCut CL100**

- plastična podloga s tankim linijama omogućava precizno rezanje papira
- ergonomski oblik ručke s nožem
- kapacitet rezanja: do 10 listova (80g/m²)
- za format A4
- pakiranje: 1
- šifra: **000000937**



Fellowes**Rezač papira Proton A4**

- odjeljci integrirani u bazu za pohranu zamjenskih oštrica (nisu uključene)
- metalna baza s gumenim protukliznim nožicama
- proziran i podesivi vodič za nož na pritisak za lakše poravnavanje dokumenata i precizan rez
- kapacitet rezanja: do 10 listova (80g/m²)
- podesiv za formate A4, A5 i A6
- pakiranje: 1
- šifra: **000024816**



Zamjenjive patrone koje izlažu samo oštricu prilikom rezanja.



Integrirani odjeljci u bazi rezača za čuvanje zamjenskih oštrica

**Rexel****Rezač papira SmartCut A425 4 u 1**

- omogućuje 4 funkcije
- ravno rezanje, perforacija, biganje i valovito rezanje
- idealan je za pozivnice, čestitke, vizit kartice, fotografije, naljepnice, dokumente
- podloga s tankim linijama, što omogućava precizno rezanje papira
- transparentno ravnalo omogućuje čvrsto držanje papira za vrijeme rezanja
- kapacitet rezanja: do 10 listova (80g/m²)
- podesiv za formate A4, A5 i A6
- pakiranje: 1
- šifra: **000000936**

**Rexel****Rezač papira SmartCut A300**

- omogućuje ravno rezanje
- idealan je za omote za CD, letke, vizit kartice, dokumente
- podloga s tankim linijama omogućava precizno rezanje papira
- transparentno ravnalo omogućuje čvrsto držanje papira za vrijeme rezanja
- kapacitet rezanja: do 10 listova (80g/m²)
- podesiv za formate: A4, A5 i A6
- pakiranje: 1
- šifra: **000000923**

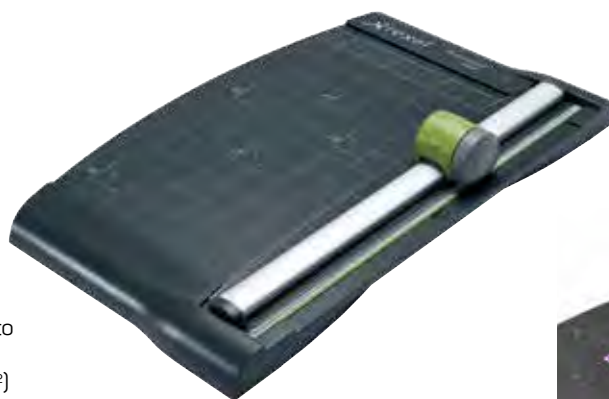



Rexel

Rezač papira SmartCut A200 3 u 1

- omogućuje 3 funkcije
- ravno rezanje, perforacija i valovito rezanje
- idealan je za pozivnice, čestitke, vizit kartice, fotografije, naljepnice, dokumente
- podloga i ravnalo su s tankim linijama, što omogućava precizno rezanje papira
- transparentno ravnalo omogućuje čvrsto držanje papira za vrijeme rezanja
- kapacitet rezanja: do 5 listova (80g/m²)
- za format A4
- pakiranje: 1
- šifra: **000011204**



Rexel

Rezač papira SmartCut A100

- podloga i ravnalo su s tankim linijama, što omogućava precizno rezanje papira
- transparentno ravnalo omogućuje čvrsto držanje papira za vrijeme rezanja
- kapacitet rezanja: do 5 listova (80g/m²)
- za format A4
- pakiranje: 1
- šifra: **000010915**



REZERVNI DIJELOVI ZA REZAČE PAPIRA



Rexel

Nož za rezač papira

- za rezače A425 i A445
- pakiranje: 1
- šifra: **000009900**



Rexel

Nož za rezač papira

- za rezače A500 i A535
- pakiranje: 1
- šifra: **000014356**

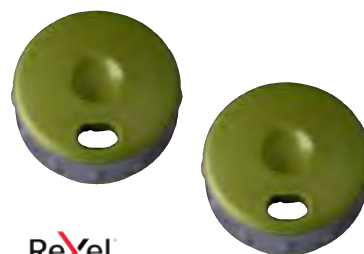

Rexel

Nož za rezač papira

- za rezač A200
- pakiranje: 1
- šifra: **000019858**

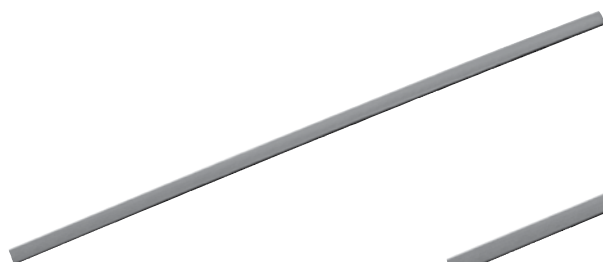

Rexel

Podložak gumeni za rezač papira

- za rezače A300 i A425
- pakiranje: 1
- šifra: **000018930**

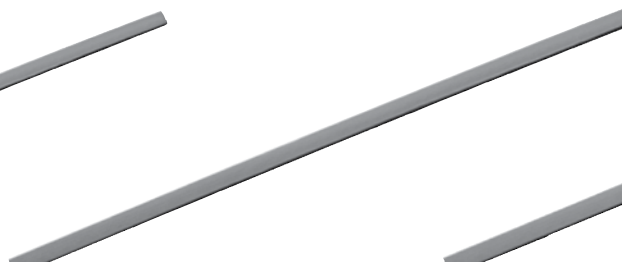

Rexel

Podložak gumeni za rezač papira

- za rezač A445
- pakiranje: 1
- šifra: **000020539**

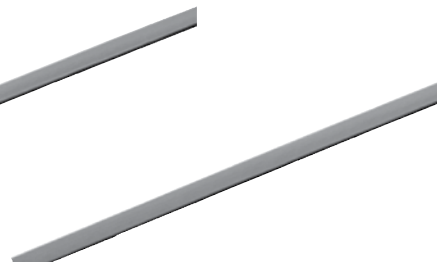

Rexel

Podložak gumeni za rezač papira

- za rezač A535
- pakiranje: 1
- šifra: **000021908**



trodat®



Automat za pečat 4910

- napravljen od 65% reciklirane plastike
- smanjen udio CO2 do 49%
- max. veličina pločice za tekst: 26x9 mm
- sort boje
- koristi jastučiće: 6/4910
- pakiranje: 10
- šifra: **000020680**

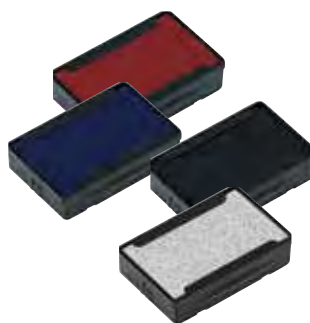

trodat®

Jastučići 6/4910

- za automat 4910
- pakiranje: 10

- 000029058
- 000018321
- 000003750
- 000018322



trodat®



Automat za pečat 4911

- napravljen od 65% reciklirane plastike
- smanjen udio CO2 do 49%
- max. veličina pločice za tekst: 38x14 mm
- sort boje
- koristi jastučiće: 6/4911
- pakiranje: 10
- šifra: **000008514**

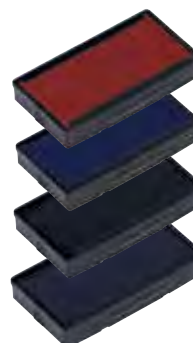

trodat®

Jastučići 6/4911

- za automat 4911
- pakiranje: 10

- 000017825
- 000000114
- 000017826
- 000017828



trodat®



Automat za pečat 4912

- napravljen od 65% reciklirane plastike
- smanjen udio CO2 do 49%
- max. veličina pločice za tekst: 47x18 mm
- sort boje
- koristi jastučiće: 6/4912
- pakiranje: 10
- šifra: **000008515**

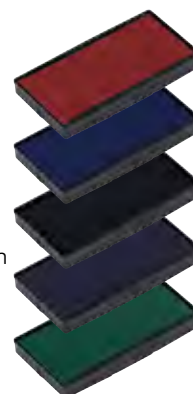

trodat®

Jastučići 6/4912

- za automat 4912
- pakiranje: 10

- 000017829
- 000000504
- 000017830
- 000017832
- 000017831



trodat®



Automat za pečat 4913

- napravljen od 65% reciklirane plastike
- smanjen udio CO2 do 49%
- max. veličina pločice za tekst: 58x22 mm
- sort boje
- koristi jastučiće: 6/4913
- pakiranje: 10
- šifra: **000008516**

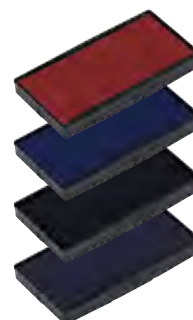

trodat®

Jastučići 6/4913

- za automat 4913
- pakiranje: 10

- 000017833
- 000003640
- 000017834
- 000017836

**trodat®****Automat za pečat 4915**

- napravljen od 65% reciklirane plastike
- smanjen udio CO2 do 49%
- max. veličina pločice za tekst: 70x25 mm
- sort boje
- koristi jastučice: 6/4915
- pakiranje: 10
- šifra: 000009299

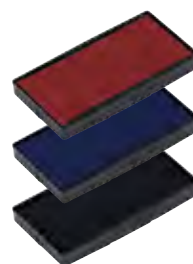
**trodat®****Jastučici 6/4915**

- za automat 4915
- pakiranje: 10

- 000017857
- 000000639
- 000017858

**trodat®****Automat za pečat 4929**

- max. veličina pločice za tekst: 50x30 mm
- koristi jastučice: 6/4929
- pakiranje: 10
- šifra: 000011077

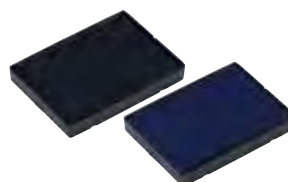
**trodat®****Jastučici 6/4929**

- za automat 4929
- pakiranje: 10

- 000011270
- 000017850

**trodat®****Automat za pečat 4926**

- max. veličina pločice za tekst: 75x38 mm
- koristi jastučice: 6/4926
- pakiranje: 10
- šifra: 000009936

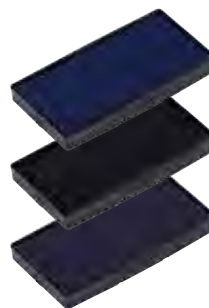
**trodat®****Jastučici 6/4926**

- za automat 4926
- pakiranje: 10

- 000010688
- 000012164
- 000012165

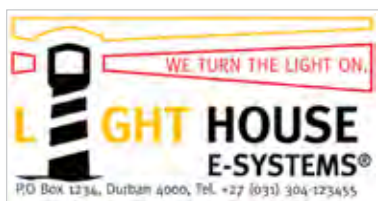
**trodat®**

TRODAT AUTOMATI ZA PEČATE, DATUMARI, NUMERATORI

Dostupni su u raznim dimenzijama, bojama i oblicima. Uz svaki automat dostupan je i jastučić u raznim bojama.

Ergonomični - pružaju korisniku udobnost i savršeno držanje u ruci. Ostavljaju pečat tiho uz jednostavan pokret.

Pouzđani - u brojnim testovima, Trodat automati za pečate su pokazali da su trajan i pouzdan proizvod.

Čisti - osiguravaju da prsti ostanu čisti tijekom podešavanja datuma i cjelodnevnog korištenja.

TRODAT BESTSELLERS

CLIMATE-NEUTRAL. AS STANDARD.



3 STEPS

AVOID CO₂

Smaller & lighter products
(so far Printy 4.0)

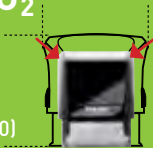

REDUCE CO₂

Post-consumer recycled plastic & 100% green electricity



COMPENSATE CO₂

Investment in Gold Standard climate protection projects



CO₂=0

trodat[®]

CREATING ORIGINALS

FOR MORE INFO
WATCH OUR NEW VIDEO!



www.trodat.net



trodat®

Automat za pečat 4630

- max. veličina pločice za tekst: Ø30 mm
- koristi jastučiće: 6/4630
- pakiranje: 10
- šifra: **000027337**

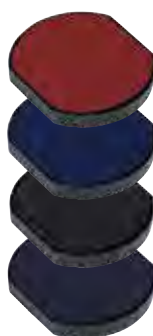

trodat®

Jastučići 6/4630

- za automat 4630
- pakiranje: 10

- **000027340**
- **000027338**
- **000027339**
- **000027341**



trodat®

Jastučići 6/46030

- za automat 46030
- pakiranje: 10

- **000017817**
- **000009490**
- **000017818**
- **000017824**



trodat®

Automat za pečat 4642

- max. veličina pločice za tekst: Ø42 mm
- koristi jastučiće: 6/4642
- pakiranje: 10
- šifra: **000027991**

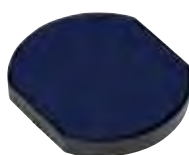

trodat®

Jastučići 6/4642

- za automat 4642
- pakiranje: 10

- **000028199**



trodat®

Jastučići 6/46040

- za automat 46040
- pakiranje: 10

- **000011221**
- **000011219**



trodat®

Automat za pečat 4921

- max. veličina pločice za tekst: 12x12 mm
- koristi jastučiće: 6/4921
- pakiranje: 10
- šifra: **000030500**

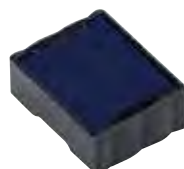

trodat®

Jastučići 6/4921

- za automat 4921
- pakiranje: 10

- **000025131**



trodat®

Automat za pečat 4922

- max. veličina pločice za tekst: 20x20 mm
- koristi jastučiće: 6/4922
- pakiranje: 10
- šifra: **000000722**

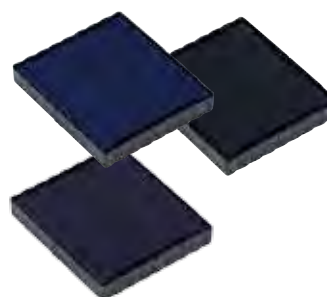

trodat®

Jastučići 6/4922

- za automat 4922
- pakiranje: 10

- **000001584**
- **000017838**
- **000017840**



trodat®

Automat za pečat 4923

- max. veličina pločice za tekst: 30x30 mm
- koristi jastučiće: 6/4923
- pakiranje: 10
- šifra: **000016770**

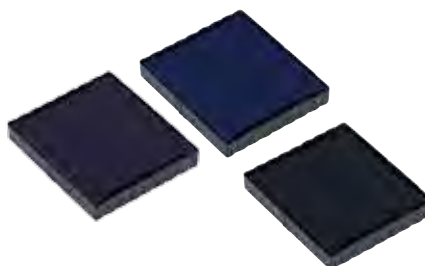

trodat®

- Jastučići 6/4923**
- za automat 4923
 - pakiranje: 10

- 000001788
- 000017842
- 000017844



trodat®

Automat za pečat 4924

- max. veličina pločice za tekst: 40x40 mm
- koristi jastučiće: 6/4924
- pakiranje: 10
- šifra: **000005680**

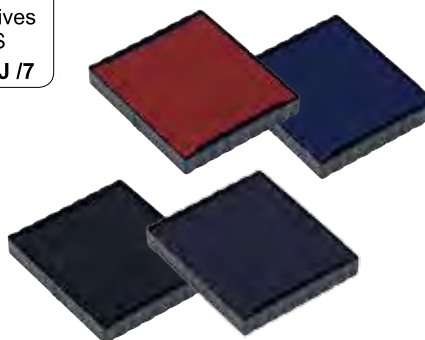

trodat®

- Jastučići 6/4924**
- za automat 4924
 - pakiranje: 10

- 000017845
- 000006325
- 000017846
- 000017848

DATUMARI I JASTUČIĆI



trodat®

Datumar 4810

- napravljen od min. 70% reciklirane plastike
- veličina datuma: 3,8 mm
- koristi jastučiće: 6/4910
- pakiranje: 10
- šifra: **000002240**

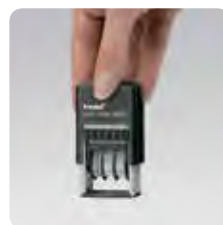

trodat®

Datumar 4750

- napravljen od min. 70% reciklirane plastike
- ispisuje tekst i datum
- max. veličina pločice za tekst: 41x24 mm
- veličina datuma: 4 mm
- koristi jastučiće: 6/4750
- pakiranje: 10
- šifra: **000004200**

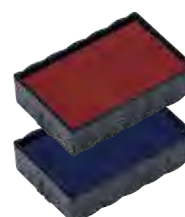

trodat®

- Jastučići 6/4750**
- za datumar 4750
 - pakiranje: 10

- 000017820
- 000007266



trodat®

Datumar 4817

- ispisuje tekst i datum
- veličina fonta: 3,8 mm
- koristi jastučiće: 6/4817
- pakiranje: 10
- šifra: **000005715**



CANCELADO 28 NOV. 2020



trodat®

Datumar 4820

- napravljen od min. 70% reciklirane plastike
- veličina datuma: 4 mm
- koristi jastučiće: 6/4911
- pakiranje: 10
- šifra: **000003567**

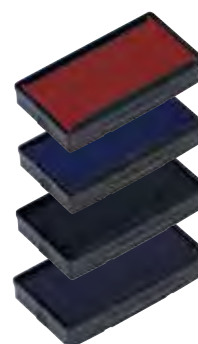

trodat®

- Jastučići 6/4911**
- za datumar 4820
 - pakiranje: 10

- 000017825
- 000000114
- 000017826
- 000017828



trodat®

Datumar 4729

- ispisuje tekst i datum
- max. veličina pločice za tekst: 50x30 mm
- veličina datuma: 3 mm
- koristi jastučiće: 6/4929
- pakiranje: 10
- šifra: **000012437**

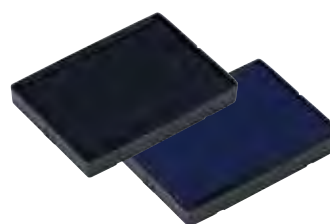

trodat®

- Jastučići 6/4929**
- za datumar 4729
 - pakiranje: 10

- 000011270
- 000017850



trodat®

Datumar 4727

- ispisuje tekst i datum
- max. veličina pločice za tekst: 60x40 mm
- veličina datuma: 4 mm
- koristi jastučiće: 6/4727
- pakiranje: 10
- šifra: **000009610**

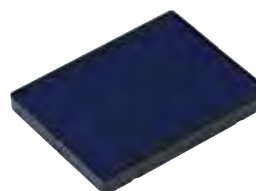

trodat®

- Jastučići 6/4927**
- za datumar 4727
 - boja: plava
 - pakiranje: 10
 - šifra: **000017861**

AUDIOLOGIE
michel marquer



17 NOV 2020

48, rue charles herbelot
35410 chateaugiron

trodat

Numerator 5756/M

- metalni
- s 6 znamenki
- visina znamenki 5,5 mm
- automatsko prebacivanje brojeva
- više različitih funkcija: ponavljanje, numeriranje u nizu, dupliciranje, ponavljanje određeni broj puta
- pakiranje: 1
- šifra: **000024145**



lebez

Numerator

- gumeni s niklovanim okvirom
- s 8 znamenki
- pakiranje: 1
- šifra: **00000986**



TINTE ZA PEČATE

fornax

Tinta za pečate

- na bazi vode, bez ulja
- 30 ml
- 4 boje
- pakiranje: 12

- **000021903**
- **000012245**
- **000012246**
- **000012244**



JASTUČIĆI ZA PEČATE



siam.

Jastučić za pečat

- natopljeni jastučić
- dimenzija jastučića: 7x14 cm
- sort boje
- pakiranje: 12
- šifra: **000003528**



trodat

Jastučić za pečat

- natopljeni jastučić
- dimenzija jastučića: 9x16 cm
- plave boje
- pakiranje: 10
- šifra: **000020315**



siam.

Jastučić za pečat

- natopljeni jastučić
- dimenzija jastučića: 7x11 cm
- plave boje
- pakiranje: 12
- šifra: **000025402**

JASTUČIĆI ZA PEČATE



Jastučić za pečat

- suhi jastučić
- nenakvašen
- dimenzija jastučića: 7x11 cm
- pakiranje: 5
- šifra: **000024004**



Jastučić za pečat S-4

- suhi jastučić
- nenakvašen
- dimenzija jastučića: 12.8x17.8 cm
- pakiranje: 12
- šifra: **000019125**

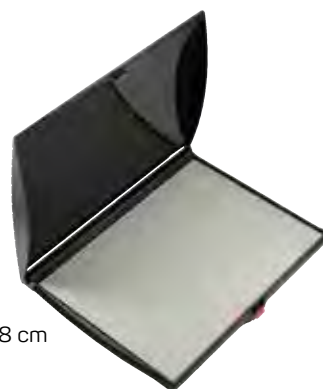

SPUŽVA NAKVASNA



Spužva nakvasna s glicerinom

- za vlaženje prstiju radi lakšeg listanja papira
- ne ostavlja masne mrlje na papiru
- netoksičan, pH od 7,5-8
- promjer pakiranja: 80 mm
- kapacitet: 20 ml
- pakiranje: 1
- šifra: **000027083**



Spužva nakvasna

- mala, za vlaženje prstiju radi lakšeg listanja papira i vrećica
- pakiranje: 1
- šifra: **000001073**



LUPE



Lupa

- PVC ručka
- povećanje 3x
- promjer 7.5 cm
- pakiranje: 1
- šifra: **000030580**



fornax

Lupa

- metalna ručka
- povećanje 6x
- promjer 5 cm
- blister pakiranje
- pakiranje: 12
- šifra: **000030934**



fornax

Lupa

- PVC ručka
- povećanje 5x
- promjer 7.5 cm
- blister pakiranje
- pakiranje: 12
- šifra: **000030935**



SETOVI UREDSKI



Set uredski C-50

- za olovke, spajalice, ljepilo, post-it, blok...
- srebrne boje
- prikladno za svaki ured
- u setu dolazi ljepilo 3M, post-it zastavice u 4 boje 3M i blok post-it 3M
- pakiranje: 1
- šifra: **000011034**



fornax

Set uredski

- žičani set
- sadrži: čašu za olovke, čašu za spajalice, stalak za pisma i stalak za papir kocku
- pakiranje: 10



- **000012262**
- **000012263**



Stalac za olovke Lux Pen Pot

- PVC stalak
- dostupan u 3 boje
- sadrži 3 odjeljka za olovke
- pakiranje: 1

- 000023427
- 000023428
- 000023429



ČAŠE ZA OLOVKE

fornax

Čaša za olovke

- praktična žičana čaša
- okrugla u srebrnoj i crnoj boji
- visina: 97 mm, Ø90 mm
- pakiranje: 12

- 000012253
- 000012252



fornax

Čaša za olovke

- praktična žičana čaša
- četvrtasta u srebrnoj i crnoj boji
- dimenzija: 80x80x98 mm
- pakiranje: 8

- 000025351
- 000012256



STALCI ZA PAPIRNU KOCKU

DRŽAČ PAPIRA



fornax

Stalac za papir kocku LD01

- praktični žičani stalak
- četvrtasta u srebrnoj i crnoj boji
- pakiranje: 6

- 000012410
- 000012409

fornax

Stalac za papirnu kocku

- prozirna PVC kutija
- dimenzija papira: 90x90x90 mm
- pakiranje: 1
- šifra: 000024593



Držać Pro330

- držać Z-listića
- crne boje
- prikladno za svaki ured
- u setu dolazi blok Z-listića
- pakiranje: 1
- šifra: 000020801



STALAK ZA KNJIGE



Stalac za knjige

- izrađena od drveta
- protuklizni čepovi
- podesiva u 3 razine nagiba
- za knjige, časopise
- dimenzija: 292x224x42 mm
- pakiranje: 1
- šifra: 000008065



fornax

Stalak za spise

- vertikalni žičani stalak
- u srebrnoj boji
- dimenzija: 80x350x275 mm
- pakiranje: 24
- šifra: **000012416**

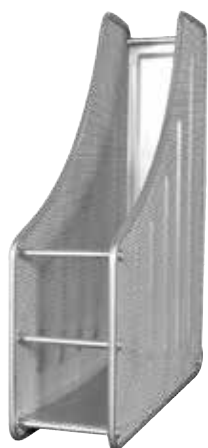

fornax

Stalak za spise

- praktični žičani stalak
- četvrtast, s 3 pretinca
- u crnoj i srebrnoj boji
- dimenzija: 173x80x140 mm
- pakiranje: 1



- 000017293
- 000030272



Esselte

Stalak za spise

- okomiti stalak za spise
- boje i tekstura police doprinose modernom i osvježavajućem izgledu ureda
- dimenzije: 75x256x260 mm
- za spise A4 formata
- materijal: polistiren
- pakiranje: 10

- 000030866
- 000030871
- 000030867
- 000030868
- 000030869
- 000030870



fornax

Stalak za spise

- okomiti stalak za spise
- za spise A4 formata
- plastični
- pakiranje: 10

- 000029968
- 000029966
- 000029967
- 000029965



fornax

Polica za spise

- žičana
- u crnoj i srebrnoj boji
- horizontalni s tri ladice
- za časopise, kataloge, spise...
- dimenzija: 278x350x275 mm
- pakiranje: 12

- 000012254
- 000012255

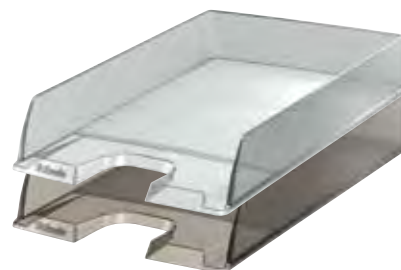

Esselte

Polica za spise Europost

- PVC polica
- za spise A4 formata
- može se slagati jedna polica na drugu
- dimenzija: 245x58x335 mm
- pakiranje: 10

- 000000265
- 000009062

fornax**Polica za spise**

- PVC polica raznih boja
- za spise A4 formata
- može se slagati jedna polica na drugu
- dimenzija: 256x66x348 mm
- pakiranje: 10

- 000032065
- 000032066
- 000032064
- 000032067
- 000032068
- 000032070
- 000032069

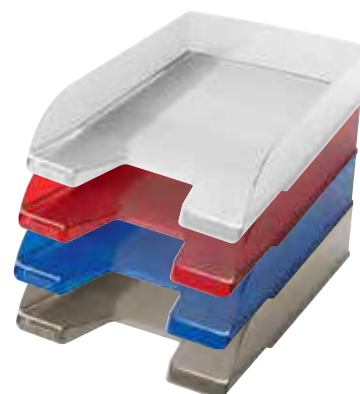
**foroffice****Polica za spise**

- PVC polica raznih boja
- za spise A4 formata
- može se slagati jedna polica na drugu
- dimenzija: 256x66x348 mm
- pakiranje: 10

- 000012292
- 000012296
- 000012291
- 000012303
- 000012297
- 000012298
- 000012301
- 000012299

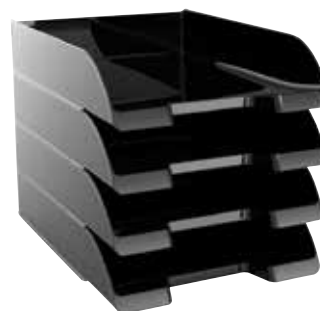

ORMARIĆI ZA SPISE

LEITZ**Ormarić za spise**

- bijela kutija s 3 ladice
- idealna za spise i dokumente formata A4
- dimenzija ormarića: 286x282x358 mm
- visina ladice: 330x251x59 mm
- pakiranje: 1
- šifra: **000031812**



EXACOMPTA
Ormarić za spise Ecobox

- siva kutija s 4 ladice, otvorena
- ima sigurnosnu kočnicu za ladice
- dimenzija ormarića: 233x283x336 mm
- dimenzija ladice: 255x333x49 mm
- pakiranje: 1
- šifra: **000032262**



EXACOMPTA
Ormarić za spise

- siva kutija s 5 ladica, otvorena
- ima sigurnosnu kočnicu za ladice
- idealna za spise i dokumente A4+
- dimenzija ormarića: 347x278x271 mm
- visina ladice: 43 mm
- pakiranje: 1
- šifra: **000032275**



EXACOMPTA
Ormarić za spise

- crna kutija s 10 ladica u boji
- ima sigurnosnu kočnicu za ladice
- idealna za spise i dokumente A4+
- dimenzija ormarića: 288x320x350 mm
- visina ladice: 26 mm
- pakiranje: 1
- šifra: **000032277**







LEITZ®

Ormarić za spise Post

- siva kutija s 5 ladicu u boji
- idealna za spise i dokumente
- dimenzija ormarića: 291x292x352 mm
- dimenzija ladice: 255x48x325 mm
- pakiranje: 1

-  • 000014011
-  • 000011079
-  • 000014321



LEITZ®

Ormarić za spise Post

- siva kutija s 10 ladicu plave boje
- idealna za spise i dokumente
- dimenzija ormarića: 291x292x352 mm
- dimenzija ladice: 255x24x325 mm
- pakiranje: 1
- šifra: **000011080**



Esselte

Ormarić za spise Intego

- siva kutija s 4 ladice u boji
- mogućnost slaganja jednog ormarića na drugi
- idealna za spise i dokumente
- dimenzija ormarića: 286x245x380 mm
- pakiranje: 1
- šifra: **000000594**

GLOBUSI



Tecnodidattica

Globus svjetleći

- za svaki ured, dom i školu
- služi kao lampa
- pakiranje: 1

Šifra	Mjerilo	Radijus
000003353	1:64.000.000	20
000003354	1:51.000.000	25
000003355	1:42.500.000	30

Tecnodidattica

Globus reljefni

- za svaki ured, dom i školu
- 3D reljef
- služi kao lampa
- radijus: 30cm
- šifra: **000031070**



Tecnodidattica

Globus svjetleći Antique

- za svaki ured, dom i školu
- u prirodnim zemljanim bojama
- služi kao lampa
- pakiranje: 1

Šifra	Mjerilo	Radijus
000030898	1:51.000.000	25
000030899	1:42.500.000	30



LUPE



Rexel

Lampa stolna Flip

- elegantni moderni dizajn
- prijenosna lampa
- lagana i sklopiva
- led svjetiljke
- 3 jačine osvjetljenja mjenjaju se na lagani dodir
- šifra: **000030489**

Rexel

Lampa stolna Pure Light Bar

- daje svjetlo nalik prirodnom sunčevom svjetlu
- mogućnost podešavanja 6 stupnjeva jačine svjetla
- pomična glava lampe
- bijela boja
- pakiranje: 2
- šifra: **000028062**

KANTE ZA SMEĆE



fornax

Kanta za smeće

- metalna, žičana
- u srebrnoj i crnoj boji
- kapacitet: 18 l
- visina 345 mm, Ø295 mm
- pakiranje: 12

- **000012258**
- **000012259**

Fellowes

Kanta za smeće G2Desk

- PVC s ručkom za lakše nošenje i pražnjenje kante
- izrađen od 80% recikliranog materijala
- deblji rub za bolje držanje vrećice za smeće
- crna boja
- kapacitet: 15 l
- dimenzija: 367x300x300 mm
- pakiranje: 1
- šifra: **000024826**



Esselte

Kanta za smeće Basko 18

- plastična s oblikovanom ručkom za nošenje
- deblji rub za bolje držanje vrećice za smeće
- u 2 boje
- kapacitet: 18 l
- visina 350 mm
- pakiranje: 12

- **000010656**
- **000010657**

**fornax****Kanta za smeće**

- od polipropilena
- dostupna u 3 boje
- kapacitet: 18 l
- pakiranje: 5

■ • 000029953

■ • 000029954

■ • 000029952

**Essette****Kanta za smeće Europost**

- plastična s oblikovanom ručkom za nošenje
- deblji rub za bolje držanje vrećice za smeće
- briljantne i sjajne boje
- crne boje
- kapacitet: 14 l
- dimenzija: 258x322x285 mm
- pakiranje: 12
- šifra: **000021182**

**fornax****Stalak za kišobrane**

- žičani, bez podloge
- crni i srebrni
- može poslužiti i za odlaganje karata i nacрта
- visina: 500 mm, Ø260 mm
- pakiranje: 5

■ • 000012261

■ • 000012260

**Kasa**

- metalna kasa s ključem
- rezervni ključ
- dimenzija: 300x240x90 mm
- pakiranje: 1
- šifra: **000012271**

**Kasa**

- metalna kasa s ključem
- rezervni ključ
- dimenzija: 250x198x90 mm
- pakiranje: 1
- šifra: **000021970**

**Kasa**

- metalna kasa s ključem
- rezervni ključ
- dimenzija: 200x160x90 mm
- pakiranje: 1
- šifra: **000023783**



lebez

Privjesci za ključeve

- plastični privjesci s metalnim prstenom
- sadrže karticu na koju se može pisati
- 5 sortiranih boja
- pakirane u plastičnoj kutiji
- pakiranje: 15
- šifra: **00001050**



Privjesci za ključeve

- plastični privjesci s metalnim prstenom
- sadrže karticu na koju se može pisati
- 5 sortiranih boja
- pakiranje: 200/1
- šifra: **000030438**



Katanac Titan 35

- s 2 ključa
- pakiranje: 1
- šifra: **000012878**

ORMARIĆI ZA KLJUČEVE



Ormarić za ključeve 5243

- metalni ormarić s ključem
- rezervni ključ
- kapacitet 93 ključa
- dimenzija: 300x240x80 mm
- pakiranje: 1
- šifra: **000024000**



Ormarić za ključeve 5242

- metalni ormarić s ključem
- rezervni ključ
- kapacitet 48 ključeva
- dimenzija: 180x250x80 mm
- pakiranje: 1
- šifra: **000023999**

OKVIRI ZA SLIKE

Okvir za slike

- PVC okvir
- s mogućnošću vješanja na zid
- pakiranje: 1

Šifra	Dimenzija (cm)
00009849	18 x 24
00009850	20 x 25
00009030	20 x 30
000021659	21 x 29,7
00001077	24 x 30
00002200	25 x 35
000021660	29,7 x 42
00001075	30 x 40
00004148	35 x 50
00006070	40 x 50
00006069	50 x 70





Ploča za tehničko crtanje 661

- ploča s paralelnom rukom za crtanje i dvostranom skalom
- dvostruki klizač
- držači crtačkog papira s obje strane daske
- skala s rupama za šiljak šestara
- format A4 i A3
- pakiranje: 1

Šifra	Oznaka	Format
000009120	661 A4	A4
000008655	661 A3	A3

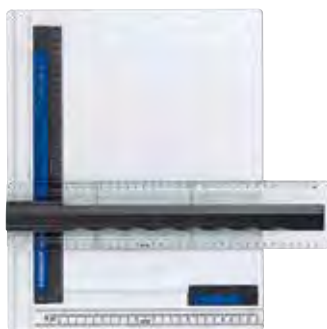

Torba 661

- torba za ploču A4 i A3
- otporna na vodu
- odvojen etui za mobitel
- ručka i pojas za nošenje koji se može skinuti
- izrađeno od izdržljivog materijala
- pakiranje: 1

Šifra	Oznaka	Format
000009115	661 14	A4
000009054	661 13	A3



Šestar 555 02 Mars Comfort

- visokokvalitetni metalni šestar
- s gumbom za brzo podešavanje i centralnim kotačićem
- krakovi za minu i šiljak sa zglobovima
- izmjenjivi dio s minom
- najveći promjer kružnice oko 400mm, s produženim krakom oko 635mm
- duljina 170mm
- set sadrži: šestar, produženi krak, univerzalni adapter i kutiju za mine, olovku tehničku i mine za olovku tehničku
- pakiranje: 1
- šifra: 000025600



Šestar Noris Club 550 50

- precizan šestar s glavom s otporom za precizno, glatko podešavanje radijusa bez trzaja
- blister kutija s poklopcem sa zglobom i ravnalom 12 cm
- sadrži: šestar i kutiju s rezervnim minama
- pakiranje: 20
- šifra: 000010297





Šestar 556 Comfort

- precizan šestar s opružnim lukom i centralnim kotačićem
- najveći Ø kružnice oko 225 mm
- duljina oko 154 mm
- blister kutija s poklopcem sadrži šestar s kutijom za mine u PVC etuji
- pakiranje: 5
- šifra: **000008646**



Connect

Šestar

- PVC kutija s poklopcem
- sadržaj: metalni šestar i kutiju s minama
- 2 sort boje
- blister pakiranje
- pakiranje: 10
- šifra: **000029425**



Connect

Šestar

- u kutiji s poklopcem
- s dodatkom mine
- mina je promjera 2 mm
- pakiranje: 1
- šifra: **000026428**



Šestar komplet

- PVC kutija s poklopcem
- sadržaj: šestar, nastavak, kutija s minama mala, te velika kutija za mine
- blister pakiranje
- pakiranje: 20
- šifra: **000015680**



Šestar komplet

- PVC kutija s poklopcem
- sadržaj: šestar i kutija s minama
- blister pakiranje
- pakiranje: 20
- šifra: **000015681**

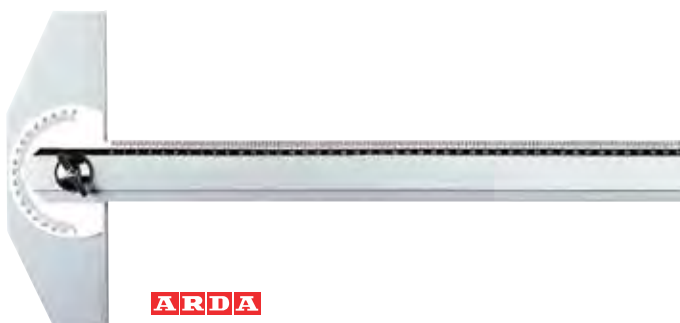

Ravnalo T

- aluminijско ravnalo
- pomična glava
- dužina 80 i 100 cm
- boja: metalik

Šifra	Dužina	Pakiranje
000014442	80 cm	10
000029014	100 cm	10



Ravnalo T

- aluminijско ravnalo
- fiksna glava
- dužina 80 cm
- boja: metalik
- pakiranje: 5
- šifra: **000014055**



Ravnalo trobridno 561 98

- 5 podjela: 1, 2, 4, 6, DIN
- utori u boji za lako prepoznavanje skala
- pakiranje: 1



Šifra	Oznaka	1:2.5	1:5	1:10	1:20	1:25	1:33.3	1:50	1:75	1:100	1:125	1:200	1:250	1:300	1:400	1:500
000010552	- DIN	•	•	•	•			•		•						
000022068	- 1				•	•		•	•	•	•					
000022069	- 2				•	•	•	•	•	•						
000022070	- 4									•		•	•	•	•	•



Ravnalo 563

- aluminijsko ravnalo
- raspon dužina od 15-50 cm

Šifra	Dužina	Pakiranje
000009742	15 cm	10
000009743	20 cm	10
000009744	30 cm	10
000009745	40 cm	10
000009746	50 cm	10



ARDA

Ravnalo

- aluminijsko ravnalo
- dužina 70 i 100 cm

Šifra	Dužina	Pakiranje
000024624	70 cm	10
000024625	100 cm	5



Ravnalo

- PVC ravnalo
- dužina: 30 cm
- pakiranje: 10
- šifra: 000030464



Ravnalo

- PVC ravnalo
- raspon dužina od 15-50 cm

Šifra	Dužina	Pakiranje
000016177	15 cm	10
000012589	20 cm	10
000012590	30 cm	10
000012591	40 cm	10
000012592	50 cm	10



Ravnalo

- PVC ravnalo
- s geometrijskim oblicima

Šifra	Dužina	Pakiranje
000030548	20 cm	10
000030549	30 cm	10





Trokut Mars 567

- PVC trokut 60°
- raspon dužina od 21-36 cm

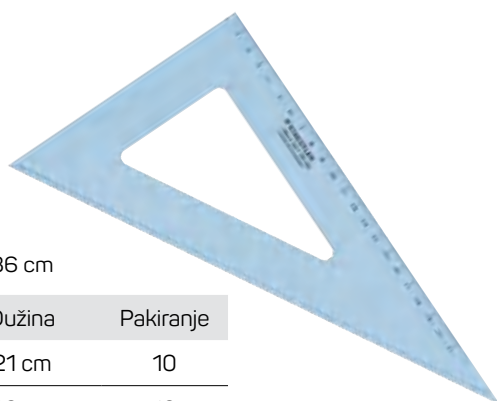

Šifra	Dužina	Pakiranje
000008651	21 cm	10
000008653	26 cm	10
000009922	31 cm	10
000009924	36 cm	10



Trokut Mars 567

- PVC trokut 45°
- raspon dužina od 21-36 cm

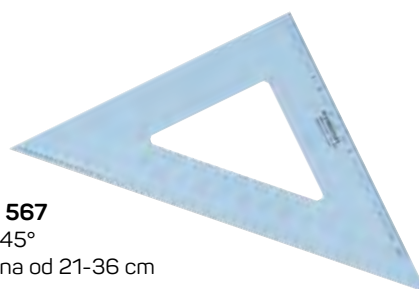

Šifra	Dužina	Pakiranje
000008650	21 cm	10
000008652	26 cm	10
000009921	31 cm	10
000009923	36 cm	10



Geometrijski set 569

- sadrži: 2 trokuta, ravnalo i kutomjer
- ravnalo od 20 cm, trokut od 15 cm, trokut od 10 cm i kutomjer 180°
- blister pakiranje
- pakiranje: 10
- šifra: 000030454



Connect

Geometrijski set 2

- sadrži: 2 trokuta, ravnalo i kutomjer
- ravnalo od 30 cm, trokut od 18 cm, trokut od 13 cm i kutomjer 180°
- blister pakiranje
- pakiranje: 24
- šifra: 000030553



Krivuljar Flex

- fleksibilni krivuljar
- dužina 40 cm
- pakiranje: 10
- šifra: 000030485



Krivuljar PK3

- blister pakiranje s 3 različita krivuljara
- pakiranje: 10
- šifra: 000012595



Kutomjer

- PVC kutomjer
- od 180°
- pakiranje: 12
- šifra: 000012593



Kutomjer

- PVC kutomjer
- od 360°
- pakiranje: 48
- šifra: 000012594





foroffice[®]

Copy with smile!





fornax
prestige

Fornax Prestige A4 D80

- ljepjenka kutije: Eska board 1,50 mm
- omot kutije: crni lmitlin 100 g
- ljepjenka uloška: Eska board 2,00 mm
- presvlaka uloška: lmitlin 100 g
- mehanizam: Niko železniki 75 mm
- paleta: nova nepovratna

- • 000013463
- • 000013461
- • 000013460
- • 000013467
- • 000013462
- • 000013465
- • 000012541
- • 000013464
- • 000013466



fornax
prestige

Fornax Prestige A4 D60

- ljepjenka kutije: Eska board 1,50 mm
- omot kutije: crni lmitlin 100 g
- ljepjenka uloška: Eska board 2,00 mm
- presvlaka uloška: lmitlin 100 g
- mehanizam: Niko železniki 50 mm
- paleta: nova nepovratna

- • 000014604
- • 000014600
- • 000014603
- • 000014601
- • 000014605
- • 000014602



fornax
prestige

Fornax Prestige A5 D80

- ljepjenka kutije: Eska board 1,50 mm
- omot kutije: crni lmitlin 100 g
- ljepjenka uloška: Eska board 2,00 mm
- presvlaka uloška: lmitlin 100 g
- mehanizam: Niko železniki 75 mm
- paleta: nova nepovratna

- • 000014599
- • 000012718



OBJAŠNENJE IKONA



- broj registratora u kutiji



- broj registratora na paleti

Lipa Mill

Lipa Mill Prestige A4 D80

- ljepjenka kutije: Eska board 1,50 mm
- omot kutije: crni lmitlin 100 g
- ljepjenka uloška: Eska board 2,00 mm
- presvlaka uloška: lmitlin 100 g
- mehanizam: Niko železniki 75 mm
- paleta: nova nepovratna

- • 000025194
- • 000025191
- • 000025195
- • 000025192
- • 000025197
- • 000025193
- • 000025196



Lipa Mill

Lipa Mill Prestige A4 D60

- ljepenka kutije: Eska board 1,50 mm
- omot kutije: crni lmitlin 100 g
- ljepenka uloška: Eska board 2,00 mm
- presvlaka uloška: lmitlin 100 g
- mehanizam: Niko železniki 50 mm
- paleta: nova nepovratna

- 000025201
- 000025198
- 000025202
- 000025199
- 000025204
- 000025200
- 000025203



Lipa Mill

Lipa Mill Neon A4 D80

- ljepenka kutije: Eska board 1,50 mm
- omot kutije: crni lmitlin 100 g
- ljepenka uloška: Eska board 2,00 mm
- presvlaka uloška: lmitlin 100 g
- mehanizam: Niko železniki 75 mm
- paleta: nova nepovratna

- 000023485
- 000023487
- 000023488
- 000023486



fornax

Fornax A4 D80

- ljepenka kutije: Eska board 1,25 mm
- omot kutije: offset 115 g
- ljepenka uloška: Eska board 1,75 mm
- presvlaka uloška: offset 100 g
- mehanizam: Niko železniki 75 mm
- paleta: nova nepovratna

- 000014587
- 000014584
- 000014518
- 000014586
- 000014585



fornax

Fornax A4 D60

- ljepenka kutije: Eska board 1,25 mm
- omot kutije: offset 115 g
- ljepenka uloška: Eska board 1,75 mm
- presvlaka uloška: offset 100 g
- mehanizam: Niko železniki 50 mm
- paleta: nova nepovratna

- 000014591
- 000014588
- 000014519
- 000014590
- 000014589



fornax

Fornax A5 D80

- ljepenka kutije: Eska board 1,25 mm
- omot kutije: offset 115 g
- ljepenka uloška: Eska board 1,75 mm
- presvlaka uloška: offset 100 g
- mehanizam: Niko železniki 75 mm
- paleta: nova nepovratna

- 000014595
- 000014592
- 000014520
- 000014594
- 000014593



Lipa Mill A4 D80

- ljepjenka kutije: Eska board 1,25 mm
- omot kutije: offset 115 g
- ljepjenka uloška: Eska board 1,75 mm
- presvlaka uloška: offset 100 g
- mehanizam: Niko železniki 75 mm
- paleta: nova nepovratna

- 000018630
- 000018627
- 000018626
- 000018629
- 000018628



Lipa Mill A4 D60

- ljepjenka kutije: Eska board 1,25 mm
- omot kutije: offset 115 g
- ljepjenka uloška: Eska board 1,75 mm
- presvlaka uloška: offset 100 g
- mehanizam: Niko železniki 50 mm
- paleta: nova nepovratna

- 000018635
- 000018632
- 000018631
- 000018634
- 000018633



Lipa Mill A5 D80

- ljepjenka kutije: Eska board 1,25 mm
- omot kutije: offset 115 g
- ljepjenka uloška: Eska board 1,75 mm
- presvlaka uloška: offset 100 g
- mehanizam: Niko železniki 75 mm
- paleta: nova nepovratna

- 000018640
- 000018637
- 000018636
- 000018639
- 000018638



Lipa Mill Eko Natur

- ljepjenka kutije: Eska board 1,25 mm
- omot kutije: Cyclus print 115 g
- ljepjenka uloška: Eska board 1,75 mm
- presvlaka uloška: Cyclus print 100 g
- mehanizam:
Niko železniki 50mm (A4/60);
Niko železniki 75mm (A4/80, A5/80)
- paleta: nova nepovratna



Šifra	Opis	Pakiranje u kutiji	Pakiranje na paleti
000018641	A4/80	11	231
000018791	A4/60	15	315
000018792	A5/80	14	294

fornax
office**Fornax Office A4 D80**

- ljepjenka kutije: Eska board 1,00 mm
- omot kutije: offset 115 g
- ljepjenka uloška: Eska board 1,50 mm
- presvlaka uloška: offset 100 g
- mehanizam: Niko železniki 75 mm
- paleta: nova nepovratna

- 000024352
- 000014973
- 000014974
- 000014976
- 000014975

**fornax**
office**Fornax Office A4 D60**

- ljepjenka kutije: Eska board 1,00 mm
- omot kutije: offset 115 g
- ljepjenka uloška: Eska board 1,50 mm
- presvlaka uloška: offset 100 g
- mehanizam: Niko železniki 50 mm
- paleta: nova nepovratna

- 000016117
- 000016116
- 000016118
- 000018864

**Lipa Mill****Lipa Mill Office A4 D80**

- ljepjenka kutije: Eska board 1,00 mm
- omot kutije: offset 115 g
- ljepjenka uloška: Eska board 1,50 mm
- presvlaka uloška: offset 100 g
- mehanizam: Niko železniki 75 mm
- paleta: nova nepovratna

- 000025208
- 000020956
- 000020955
- 000020958
- 000020957

**Lipa Mill****Lipa Mill Office A4 D60**

- ljepjenka kutije: Eska board 1,00 mm
- omot kutije: offset 115 g
- ljepjenka uloška: Eska board 1,50 mm
- presvlaka uloška: offset 100 g
- mehanizam: Niko železniki 50 mm
- paleta: nova nepovratna

- 000020960
- 000020959
- 000020962
- 000020961

**foroffice****Foroffice A4 D80**

- crna kutija od valovitog kartona 1,40 mm
- ljepjenka uloška: Eska board 1,50 mm
- presvlaka uloška: offset 100 g
- mehanizam: Niko železniki 75 mm
- paleta: nova nepovratna

- 000016188
- 000014579
- 000014578
- 000014847
- 000014846



foroffice**Foroffice A4 D60**

- crna kutija od valovitog kartona 1,40 mm
- ljepjenka uloška: Eska board 1,50 mm
- presvlaka uloška: offset 100 g
- mehanizam: Niko železniki 50 mm
- paleta: nova nepovratna

- 000014581
- 000014580
- 000016115

**forten****Forten A4 D80**

- kutija od valovitog natur kartona
- uložak je kaširan 100 g offset
- presvlaka uloška: offset 100 g
- mehanizam: Niko železniki 75 mm
- paleta: nova nepovratna

- 000028446
- 000028889



REGISTRATORI SAMOSTOJEĆI

fornax
premium**Fornax premium A4 D80**

- ljepjenka: Eska board 2,00 mm
- vanjska presvlaka: PVC Balacron Mystere u 12 boja
- džepić s naljepnicom
- 2 metalne lajsne
- unutarnja presvlaka: PVC Balacron Mystere u 12 boja
- mehanizam: Niko železniki 80 mm
- paleta: nova nepovratna

- 000015696
- 000015710
- 000015712
- 000015714
- 000015717
- 000015707
- 000015709
- 000015701
- 000015705
- 000015698
- 000015690
- 000015703

**fornax**
premium**Fornax premium A4 D55**

- ljepjenka: Eska board 2,00 mm
- vanjska presvlaka: PVC Balacron Mystere u 12 boja
- džepić s naljepnicom
- 2 metalne lajsne
- unutarnja presvlaka: PVC Balacron Mystere u 12 boja
- mehanizam: Niko železniki 55 mm
- paleta: nova nepovratna

- 000015708
- 000015719
- 000015722
- 000015723
- 000015724
- 000015716
- 000015718
- 000015711
- 000015715
- 000015702
- 000015706
- 000015713





fornax
master

Fornax master A4 D80

- ljepenka: Eska board 1,75 mm
- vanjska presvlaka: PVC Balacron Mystere u 12 boja
- džepić s naljepnicom
- unutarnja presvlaka: offset 100 g
- mehanizam: Niko železnici 80 mm
- paleta: nova nepovratna

• 000015693	• 000015700	• 000015692
• 000015695	• 000015694	• 000015688
• 000015697	• 000015686	• 000015687
• 000015699	• 000015689	• 000015691



fornax
master

Fornax master A4 D55

- ljepenka: Eska board 1,75 mm
- vanjska presvlaka: PVC Balacron Mystere u 12 boja
- džepić s naljepnicom
- unutarnja presvlaka: offset 100 g
- mehanizam: Niko železnici 55 mm
- paleta: nova nepovratna

• 000015721	• 000015735	• 000015729
• 000015732	• 000015730	• 000015726
• 000015733	• 000015731	• 000015725
• 000015734	• 000015727	• 000015728



fornax
office

Fornax office A4 D75

- ljepenka: Eska board 1,75 mm
- vanjska presvlaka: offset 100 g
- unutarnja presvlaka: offset 100 g
- 2 metalne lajsne
- mehanizam: Niko železnici 75 mm
- paleta: nova nepovratna

• 000016063
• 000015777
• 000015776
• 000016062
• 000016061



fornax
office

Fornax office A4 D50

- ljepenka: Eska board 1,75 mm
- vanjska presvlaka: offset 100 g
- unutarnja presvlaka: offset 100 g
- 2 metalne lajsne
- mehanizam: Niko železnici 50 mm
- paleta: nova nepovratna

• 000016066
• 000015779
• 000015778
• 000016065
• 000016064





Fascikla Panorama s mehanizmom

- PVC fascikle bijele boje
- džepići za personalizaciju na prednjoj strani i hrptu
- mehanizam s 4 prstena
- tri vrste prstena

	Šifra	Boja	Dimenzija (cm)	Mehanizam Ø (cm)	Kapacitet listova 80g/m ²	Pakiranje
	000005938	<input type="checkbox"/>	22x30	1.6	80	10
	000006090	<input type="checkbox"/>	24.5x30.5	2.5	100	20
	000000101	<input type="checkbox"/>	24.5x30.5	3D	200	16
	000004039	<input type="checkbox"/>	22x30	6.5	500	8



EXACOMPTA

Fascikla s mehanizmom

- materijal korice PP
- džep za personalizaciju vanjski
- za format A4
- unutarnji džep za odlaganje viška papira, CD-a...

	Šifra	Boja	Broj prstena	Mehanizam Ø (mm)	Hrbat (mm)	Pakiranje
	000026367	<input type="checkbox"/>	2	Ø 25	44	10
	000026368	<input checked="" type="checkbox"/>	2	Ø 25	44	10
	000026371	<input type="checkbox"/>	4	Ø 16	34	10
	000026369	<input type="checkbox"/>	4	Ø 25	44	10
	000026372	<input type="checkbox"/>	4	Ø 30	44	10
	000026374	<input checked="" type="checkbox"/>	4	Ø 30	44	10
	000026370	<input type="checkbox"/>	4	Ø 40	60	10
	000026375	<input checked="" type="checkbox"/>	4	Ø 40	60	10
	000026376	<input type="checkbox"/>	4	Ø 50	70	10
	000026377	<input checked="" type="checkbox"/>	4	Ø 50	70	10
	000026373	<input type="checkbox"/>	4	Ø 60	86	10
	000026378	<input checked="" type="checkbox"/>	4	Ø 60	86	10







Fascikla s mehanizmom

- kartonska fascikla s omotom od polipropilena
- u raznim bojama
- s 4 prstena
- ima naljepnicu
- za format A4









Šifra	Boja	Dimenzija (cm)	Mehanizam Ø (cm)	Kapacitet listova 80g/m ²	Pakiranje
 000005586		21 x2 9.7	Ø 2.5	100	10
000000007		21 x2 9.7	Ø 2.5	100	10



Fascikla s mehanizmom

- kartonska fascikla s omotom od polipropilena
- u raznim bojama
- s 2 prstena
- ima naljepnicu
- za format A4









Šifra	Boja	Dimenzija (cm)	Mehanizam Ø (cm)	Kapacitet listova 80g/m ²	Pakiranje
 000000338		21 x2 9.7	Ø 2.5	100	10
000000585		21 x2 9.7	Ø 2.5	100	10
000000090		21 x2 9.7	Ø 2.5	100	10
000002319		21 x2 9.7	Ø 2.5	100	10
000003161		21 x2 9.7	Ø 2.5	100	10



Fascikla s mehanizmom

- PVC fascikle u raznim bojama
- mehanizam s 4 prstena



Šifra	Boja	Dimenzija (cm)	Mehanizam Ø (mm)	Kapacitet listova 80 g/m ²	Pakiranje
 000011647		24.5x30.5	Ø 30	100	20
000011656		24.5x30.5	Ø 30	100	20
000011658		24.5x30.5	Ø 30	100	20
000011655		24.5x30.5	Ø 30	100	20
000017011		24.5x30.5	Ø 30	100	20



Fascikla s mehanizmom

- PVC fascikle u raznim bojama
- džepi za personalizaciju na prednjoj strani i hrptu
- mehanizam s 4 prstena
- 2 vrste prstena



	Šifra	Boja	Dimenzija (cm)	Mehanizam Ø (mm)	Kapacitet listova 80 g/m ²	Pakiranje
	000011648		24.5x30.5	Ø 30	100	24
	000011654		24.5x30.5	Ø 30	100	24
	000011790		24.5x30.5	Ø 40	200	12
	000011791		24.5x30.5	Ø 40	200	12
	000011692		24.5x30.5	Ø 50	300	12
	000011695		24.5x30.5	Ø 50	300	12
	000011693		22x30	Ø 65	500	12
	000011697		22x30	Ø 65	500	12



RED-BW®

Fascikla s mehanizmom

- PP fascikla
- u raznim bojama
- mehanizam s 4 prstena
- kapacitet: 200 listova
- hrbat: 30 mm
- za format A4
- pakiranje: 6
- šifra: **000011393**

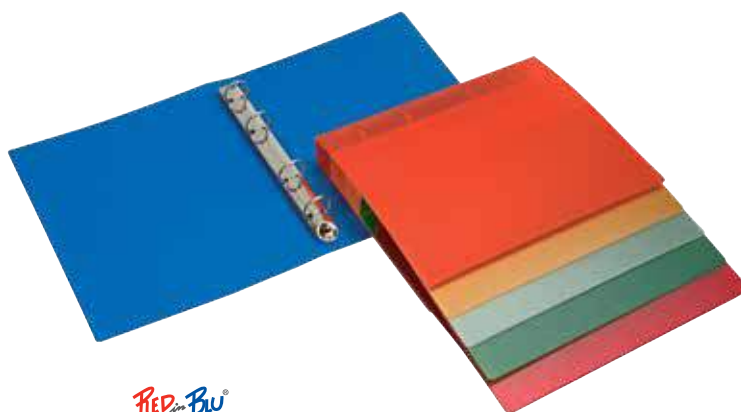

RED-BW®

Fascikla s mehanizmom

- PP transparentna fascikla
- u raznim bojama
- mehanizam s 4 prstena
- hrbat: 16 mm
- za format A4
- pakiranje: 6
- šifra: **000011253**



DONAU

Fascikla s mehanizmom

- PP folija s vanjske strane
- plave boje
- mehanizam s 2 prstena, Ø20 mm
- hrbat: 30 mm
- dimenzija: 190x230 mm
- za format A5
- pakiranje: 10
- šifra: **000024020**



FASCIKLE S KLIZNIM MECHANIZMOM

**Fascikla s mehanizmom**

- format A4
- s uložnom trakom
- univerzalna perforacija
- prednja strana prozirna (150 mikrona), zadnja u boji (160 mikrona)
- dimenzija: 235x310 mm
- pakiranje: 10
- šifra: **000023084**

**fornax****Fascikla s mehanizmom**

- fascikla s kliznim mehanizmom
- transparentna prednja strana
- zadnja strana u raznim bojama
- za format A4
- dimenzija: 225x310 mm
- pakiranje: 25

- 000013402
- 000012277
- 000012276
- 000012275
- 000013401

Fascikla s mehanizmom Omiplast

- fascikla s kliznim mehanizmom: krakovi mehanizma su duži pa može obuhvatiti više listova
- transparentna prednja strana
- zadnja strana u raznim bojama
- za format A4
- pakiranje: 25

- 000018354
- 000018353
- 000020560
- 000000177
- 000018355



FASCIKLE S KOČEĆIM MECHANIZMOM

**Fascikla s kočećim mehanizmom**

- transparentna prednja strana
- zadnja strana u raznim bojama
- pogodna za arhiviranje
- kapacitet: 20 listova
- dimenzija: 220x300 mm
- za format A4
- pakiranje: 1

- 000000971
- 000019346
- 000019982
- 000019345
- 000019347



FASCIKLE PAPIRNE

fornax**Fascikla VIP Ten**

- papirna fascikla
- boja bijela
- format: A4
- gramatura: 250 g/m²
- pakiranje: 200
- šifra: **000011122**

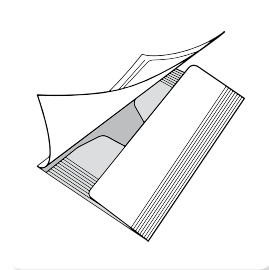

fornax**Fascikla VIP Ten**

- papirna fascikla
- lakirana
- raznih boja
- format: A4
- gramatura: 210 g/m²
- pakiranje: 25

- 000010469
- 000010466
- 000010468
- 000010465
- 000010464
- 000010467

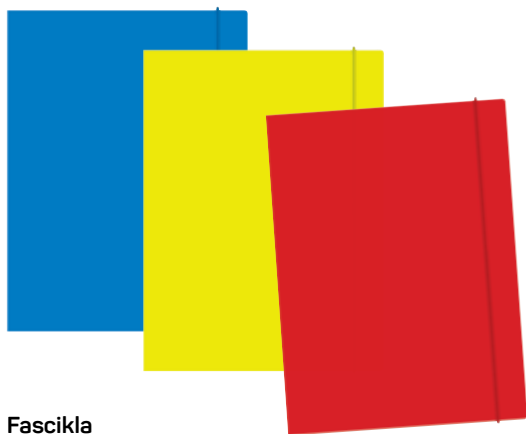
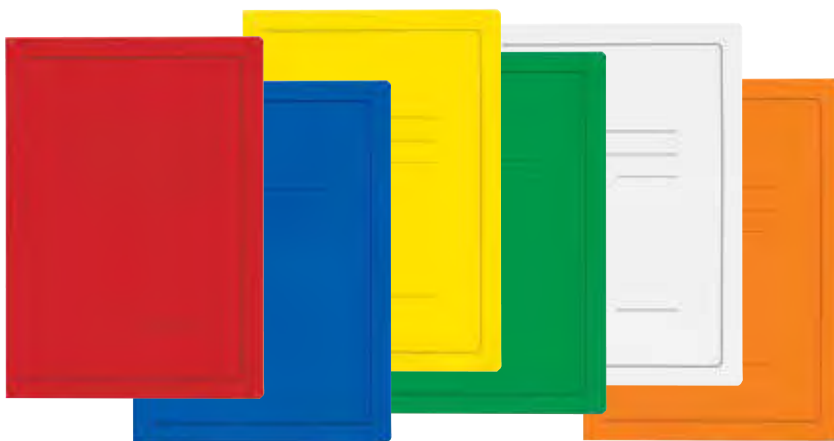
**Fascikla**

- plastificirana s gumicom
- dostupna u 3 boje
- za format A5
- dimenzija: 170x240 mm
- pakiranje: 10
- šifra: **000001445**

fornax**Fascikla**

- lakirana s gumicom
- unutrašnjost bijele boje
- dostupna u 3 boje
- format: A4
- gramatura: 350 g/m²
- pakiranje: 80

- 000011243
- 000024058
- 000024057

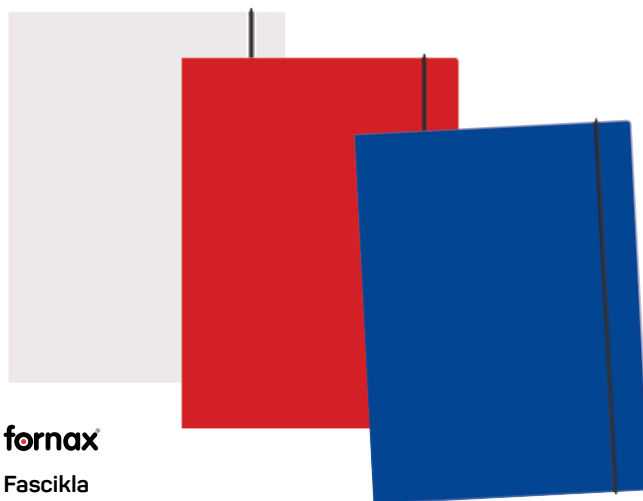
**fornax****Fascikla**

- plastificirana s gumicom
- raznih boja
- format: A4
- gramatura: 600 g/m²
- pakiranje: 10

- 000028042
- 000028047
- 000028044
- 000028043
- 000028045
- 000028046





fornax[®]



BRUNNEN

Fascikla

- kartonska s dvije gumice
- raznih boja
- dimenzija: 234x315 mm
- pakiranje: 10
- šifra: **000017539**



CIAC

Fascikla

- lakirana s gumicom
- prešpan karton
- raznih boja
- dimenzija: 250x353 mm
- format: B4
- pakiranje: 40
- šifra: **000000871**



Fascikla Croma

- plastificirana s gumicom
- raznih boja
- dimenzija: 353x500 mm
- format: B3
- pakiranje: 1
- šifra: **000000159**

CIAC

Fascikla

- papirna fascikla s gumicom
- raznih boja
- dimenzija: 500x707 mm
- format: B2
- pakiranje: 12
- šifra: **000010259**



Fascikla Croma D7

- papirna plastificirana fascikla s gumicom
- sort boje
- širina fascikle: 7 cm
- format: B4
- pakiranje: 8
- šifra: **000001470**

DONAU

Fascikla

- kartonska fascikla debljine 1,7 mm s gumicom, s vanjske strane presvučena polipropilenom od 100 µm
- dvije kratke stranice od plastike
- raznih boja
- kapacitet oko 230 stranica (80g/m²)
- širina fascikle: 3 cm
- format: B4
- dimenzija: 30x320x240mm
- pakiranje: 10



• **000024008**

• **000024009**

• **000024007**

GRAFOTISAK

Fascikla D3

- papirna plastificirana fascikla s gumicom
- raznih boja
- širina fascikle: 3 cm
- format: B4
- pakiranje: 16

- 000012996
- 000012998
- 000012999
- 000012997
- 000016775



RED in BW

Fascikla s gumicom D5 Notami

- papirna plastificirana fascikla s gumicom
- sort boje
- širina fascikle: 5 cm
- dimenzija: 22x33 cm
- za format A4
- pakiranje: 6
- šifra: 000031804

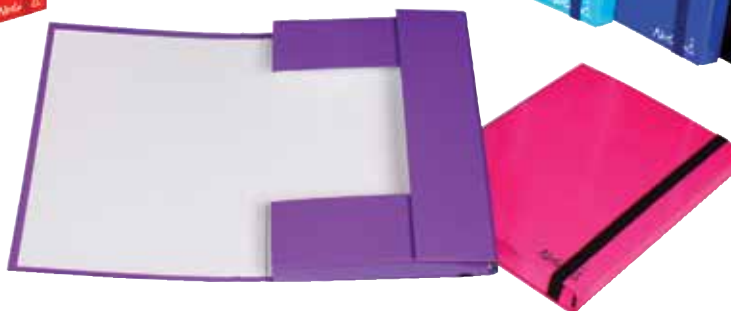

FASCIKLE ARHIVSKE



fornax

Fascikla arhivska

- kvalitetni karton
- vrpca 1 m
- mramorna boja
- za format A4
- dimenzija: 330x240 mm
- pakiranje: 50
- šifra: 000011320

DONAU

Fascikla arhivska

- bez viseće klapne
- presvučena PP filmom
- debljina kartona 1,9-2,5 mm
- mix boje
- dimenzija: 235x32 mm
- pakiranje: 20
- šifra: 000026234

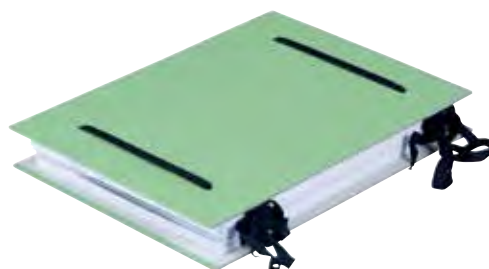
**Fascikla arhivska**

- čvrsti karton
- s vezicom
- hrbat: D10, D12, D15
- za format A4
- dimenzija: 250x350 mm
- pakiranje: 10

D10 • 000000872

D12 • 000001861

D15 • 000007232

**Fascikla**

- izrađena od polipropilena 480 µm, polutransparentan
- dvije gumice u boji fascikle na kutevima za zatvaranje
- naljepnica na prednjoj strani za lakšu identifikaciju sadržaja
- crne i plave boje
- unutarnji džep veličine: 94x56 mm
- format: A4
- dimenzija: 245x315 mm
- pakiranje: 25

 • 000024011

 • 000024010

**Fascikla**

- izrađena od tvrdog polipropilena
- s gumicom i 3 klapne
- idealna za odlaganje spisa
- bijele boje
- kapacitet (30mm): 300 listova (80g/m²)
- kapacitet (15mm): 150 listova (80g/m²)
- dimenzija A4: 250x350 mm
- dimenzija A3: 350x450 mm
- pakiranje: 1
- šifra A3 (15mm): **000019889**
- šifra A4 (15mm): **000019886**
- šifra A4 (30mm): **000019888**

**Fascikla**

- PVC fascikla s gumicom
- s 12 pregrada
- sort boje
- dimenzija: 270x130 mm
- pakiranje: 1
- šifra: **000014943**

**Fascikla**

- PVC fascikla s gumicom
- s 12 velikih pregrada
- dodatni manji džepić s 5 pregrada
- 2 mala unutarnja džepića
- sort boje
- dimenzija: 230x330 mm
- pakiranje: 1
- šifra: **000018830**

**Fascikla Q-Connect**

- PP fascikla s gumicom
- s 12 pregrada
- plave boje
- za format: A4
- dimenzija: 330x240x30 mm
- pakiranje: 1
- šifra: **000027860**

**Fascikla/torba s pregradama**

- s ručkom i kopčom za zatvaranje
- 26 prozirnih PP pregrada prilagođena formatu A4
- 24 kartice za indeksiranje pregrada
- crne boje
- dimenzija: 330x240x75 mm
- pakiranje: 1
- šifra: **000024014**

**Fascikla Notami**

- s gumicom
- izrađena od polipropilena
- za format A4
- hrbat: 2 cm
- sort boje
- dimenzija: 22x33 cm
- pakiranje: 10
- šifra: **000032520**





Rexel

Fascikla Active

- s dugmetom, u obliku kuverte
- od polipropilena u raznim bojama
- idealna za papire i projekte
- kapacitet: 150 listova
- format: A5
- pakiranje: 5/1
- šifra: **000016168**



RED-BLUE

Fascikla

- s dugmetom, u obliku kuverte
- od polipropilena debljine 180µm
- prozirna, plava boja i sort boje
- kapacitet: 50 listova
- format: A4
- dimenzija: 330x235 mm
- pakiranje: 12

• **000032502**

• **000032503**

sort boje • **000033847**

FASCIKLE NOVINARSKJE



Esselte

Fascikla novinarska s preklopom

- PVC s kvačicom za vješanje
- metalna štipaljka koja može držati do 200 listova
- s džepićem i držačem za olovku
- za format A4
- dostupna u crnoj, plavoj i crvenoj boji
- dimenzija: 242x349 mm
- pakiranje: 10

• **000003167**

• **000006780**

• **000004305**



Fascikla novinarska s preklopom SEI 4972

- PVC s kvačicom za vješanje
- metalna štipaljka koja može držati do 100 listova
- s džepićem
- za format A4
- dostupna u plavoj i crvenoj boji
- dimenzija: 240x310 mm
- pakiranje: 10
- šifra: **000001022**

DONAU

Fascikla novinarska s preklopom

- napravljena od polipropilena s metalnom kvačicom za vješanje
- metalna štipaljka koja može držati do 80 listova (80 g/m²)
- široki hrbat omogućuje nakupljanje velikih količina dokumenata
- s unutarnjim trokutastim džepićem i umetak za olovku
- za format A4
- dostupna u crnoj, plavoj i crvenoj boji
- dimenzija: 230x320 mm
- pakiranje: 12

• **000025247**



• **000025249**

• **000025248**



fornax**Fascikla novinarska s preklopom**

- karton presvučen PP-om
- s kvačicom za vješanje
- metalna štipaljka
- s džepićem
- za format A4
- dostupna u crnoj, plavoj i crvenoj boji
- pakiranje: 30

-  • 000026759
-  • 000026758
-  • 000026760



**fornax****Fascikla novinarska jednostrana**

- karton presvučen PP-om
- s kvačicom za vješanje
- metalna štipaljka
- za format A4
- dostupna u crnoj, plavoj i crvenoj boji
- pakiranje: 40

-  • 000026756
-  • 000026755
-  • 000026757

Esselte**Fascikla novinarska jednostrana**

- PVC s kvačicom za vješanje
- metalna štipaljka koja može držati do 200 listova
- za format A4
- dostupna u crnoj, plavoj i crvenoj boji
- dimenzija: 232x349 mm
- pakiranje: 10

-  • 000000256
-  • 000009190
-  • 000000260

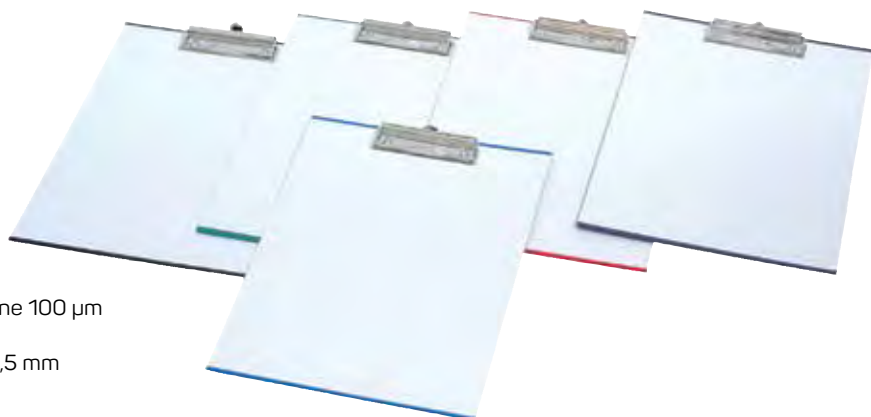
**Fascikla novinarska jednostrana**

- jednostrano obložen polipropilenom debljine 100 µm
- s kvačicom za vješanje
- napravljen od kartona debljine cca. 1,9 - 2,5 mm
- za format A4
- u raznim bojama
- dimenzija: 232x320 mm
- pakiranje: 10
- šifra: **000024015**

**LEITZ®****Fascikla Alpha**

- reciklirani papir 275 g/m²
- boja: plava i crvena
- za format A4
- dimenzija: 348x260 mm
- pakiranje: 25

 • 000027267

 • 000011758

**Esselte****Fascikla Classic**

- reciklirani papir 205 g/m²
- boja: plava
- dimenzija: 390x240 mm
- pakiranje: 25
- šifra: 000004254

**Esselte****Fascikla Classic**

- reciklirani papir 205 g/m²
- boje: plava, žuta, crvena, zelena
- dimenzija: 330x240 mm
- pakiranje: 25

 • 000013259

 • 000000351

 • 000000354

 • 000015028

**fornax****Fascikla**

- reciklirani papir 205 g/m²
- boje: plava, žuta, crvena, natron smeđa i zelena
- za format: A4
- dimenzija: 330x240 mm
- pakiranje: 5/1

 • 000024683

 • 000024680

 • 000024679

 • 000024681

 • 000024682



LEITZ®**Kutija za fascikle Plus**

- dolazi s 5 plavih visećih fascikli
- kompaktna kutija za svaki uredski stol
- pogodna za arhiviranje
- dimenzija: 400x275x170 mm
- pakiranje: 4

 • 000013902

 • 000013901

 • 000013903

**DONAU****Kutija za fascikle**

- dolazi s 5 visećih fascikli
- pogodna za arhiviranje
- kapacitet: 20 visećih mapa
- dimenzija: 345x260x160 mm
- pakiranje: 4

 • 000026126

 • 000026125

 • 000026127

 • 000026124

**DONAU****Kutija za fascikle s poklopcem**

- poklopac s ručkom za nošenje
- sive boje
- pogodna za arhiviranje
- kapacitet: 20 visećih mapa
- dimenzija: 397x154x347 mm
- pakiranje: 5
- šifra: 000031377

Fascikla sklopiva prešpan

- s metalnim dugmičima za sklapanje
- širina hrpta: 6, 8, 10 i 12 cm
- format: A4
- pakiranje: 1

D6 • 000001767

D8 • 000001554

D10 • 000000053

D12 • 000000873

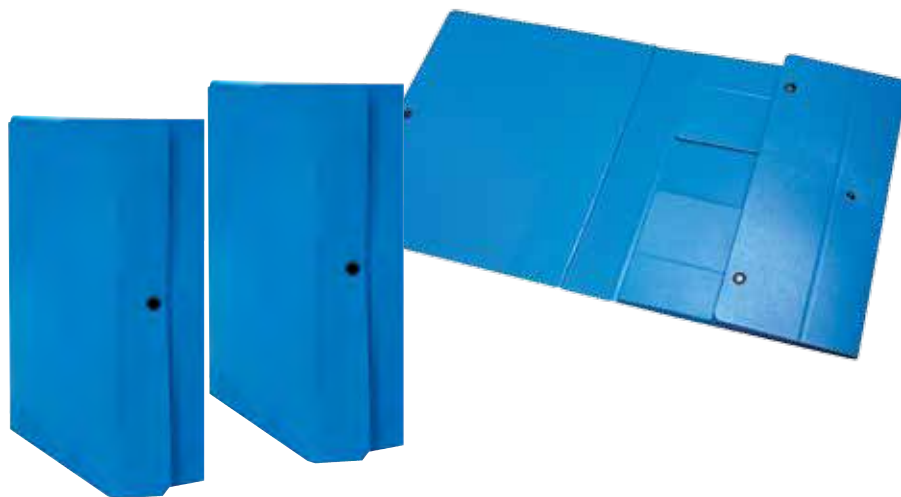

KUTIJE ARHIVSKE

fornax**Kutija arhivska**

- format: A4
- dimenzija: 297x339x80 mm
- pakiranje: 20
- šifra: 000033858

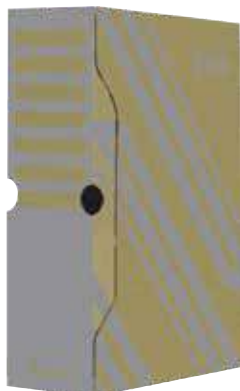
**fornax****Kutija arhivska**

- format: A4
- dimenzija: 297x339x100 mm
- pakiranje: 20
- šifra: 000032519

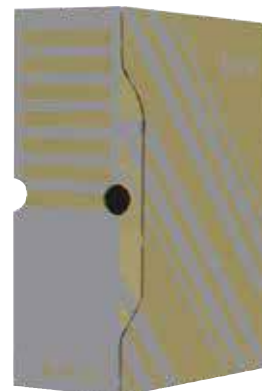
**fornax****Kutija arhivska - kontejner**

- za 6 registratora ili 5 arhivskih kutija
- s ručkama za nošenje
- dimenzija: 525x351x305 mm
- pakiranje: 10
- šifra: 000023634

**fornax****Kutija arhivska - kontejner**

- za 5 arhivskih kutija hrpta 100mm ili 6 arhivskih kutija hrpta 80mm
- s ručkama za nošenje
- dimenzija: 540x360x253 mm
- pakiranje: 20
- šifra: 000023092

fornax[®]

Rješenje za svaki ured...





NIKO

Mehanizam za fascikle komplet

- klizni mehanizam za fascikle
- pakiranje: 1000
- šifra: **000009431**



NIKO

Mehanizam

- klizni mehanizam za fascikle
- pakiranje: 1200
- šifra: **000001196**

DONAU

Mehanizam

- od polipropilena
- za uvez papira do debljine 7 cm
- duljina: 10,5 cm
- udaljenost između utora: 8 cm
- pakiranje: 100
- šifra: **000029566**

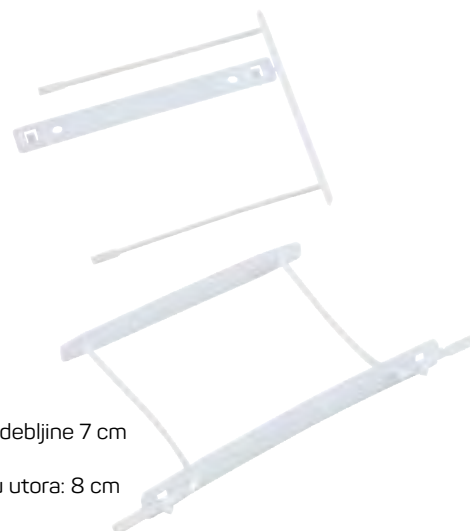

Esselte

Mehanizam za fascikle

- polipropilenska folija s metalnim mehanizmom
- razmak između rupica je 6-8 cm
- dimenzija: 35x158 mm
- pakiranje: 25

- **000001576**
- **000003028**
- **000004308**
- **000003919**

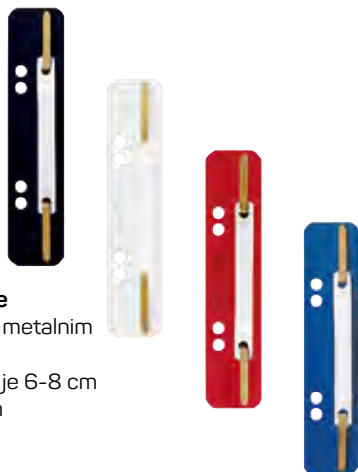

DONAU

Mehanizam za fascikle

- polipropilenska folija s aluminjskim mehanizmom
- razmak između rupica je 6-8 cm
- dimenzija: 34x150 mm
- pakiranje: 25/1

- **000029567**
- **000029419**
- **000029568**
- **000029569**



FASCIKLE "L"



fornax

Fascikla "L"

- mat, prozirna
- proizvedena od polipropilena, 80 mikrona
- za format A4
- unutrašnja dimenzija: 218x301 mm
- vanjska dimenzija: 219x305 mm
- pakiranje: 50
- šifra: **000013872**



fornax

Fascikla "L"

- sjajna, prozirna
- proizvedena od polipropilena, 100 mikrona
- za format A4
- unutrašnja dimenzija: 218x302 mm
- vanjska dimenzija: 219x306 mm
- pakiranje: 50
- šifra: **000013873**

**Fascikla "U" Office**

- mat, prozirna
- proizvedena od polipropilena

Šifra	Dimenzija (mm)	Gramatura (g/m ²)	Pakiranje
000010377	330x250	8.5	100
000015967	220x300	7.5	100
000001928	300x420	8.5	50
000001923	420x300	8.5	50

**Favorit****Fascikla "U" Favorit**

- sjajna, prozirna
- proizvedena od polipropilena

Šifra	Dimenzija (mm)	Debljina (mic)	Pakiranje
000006921	220x300	50	100
000015342	220x300	100	50
000015343	220x300	150	100

**fornax****Fascikla "U"**

- proizvedena od polipropilena
- za format A4
- unutrašnja dimenzija: 210x297 mm
- vanjska dimenzija: 230x304 mm
- pakiranje: 100/1

Šifra	Debljina (mic)
000013702	50
000013701	40

**fornax****Fascikla "U"**

- sjajna, proizvedena od polipropilena
- za format A4
- unutrašnja dimenzija: 212x299 mm
- vanjska dimenzija: 230x302 mm

Šifra	Debljina (mic)	Pakiranje
000013871	60	100/1
000013831	130	50/1
000013830	90	50/1

**fornax****Fascikla "U"**

- sjajna, prozirna
- proizvedena od PP
- za format A4
- unutarnja dimenzija: 210x297 mm
- debljina: 100 mikrona
- pakiranje: 100
- šifra: **000027017**

**Fascikla "U"**

- PVC prozirna
- debljina 150 mikrona
- dimenzija: 200x300 mm
- za format A4
- pakiranje: 50
- šifra: **000012079**

**Fascikla "U" za vizit karte**

- prozirna, proizvedena od polipropilena
- univerzalna perforacija
- može se umetnuti u registratore, te fascikle s mehanizmom
- dimenzija: 220x300 mm
- kapacitet: 16 vizit kartica
- pakiranje: 10
- šifra: **000012187**

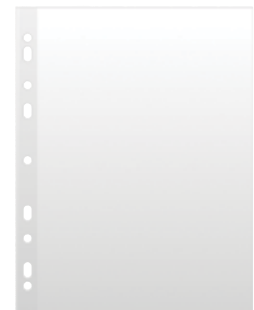
**Fascikla "U"**

- sjajna, proizvedena od polipropilena
- antistatička
- za format A5
- unutarnja dimenzija: 171x215 mm
- debljina: 50 mikrona
- pakiranje: 100
- šifra: **000020492**



**Fascikla uložna**

- potpuno prozirna
- proizvedena od polipropilena
- prednja strana se može personalizirati
- za format A4

Šifra	Broj uložaka	Pakiranje
000014965	10	24
000014966	20	24
000014967	30	24
000014968	40	12
000014969	50	12
000014970	60	12
000014971	80	6
000014972	100	6

**Fascikla uložna**

- proizvedena od polipropilena
- otvara se za 180°
- dostupna u crnoj, plavoj i crvenoj boji
- za format A4
- unutrašnja dimenzija: 210x300 mm
- pakiranje: 50

Broj uložaka				Pakiranje
10	000012915	000009075	000000200	25
20	-	000000210	000000221	15
30	-	000000225	000000227	12
40	-	000000236	000000242	10
50	-	-	-	10
60	000010815	-	-	6

**Fascikla uložna**

- PVC korice
- sort boje
- za format A4
- dvije gumice u boji fascikle na kutevima za zatvaranje

Šifra	Broj uložaka	Pakiranje
000026565	10	120
000026566	20	120
000026567	30	96
000026568	40	72
000026569	60	60
000026570	80	36
000026571	100	36





EXACOMPTA

Fascikla uložna

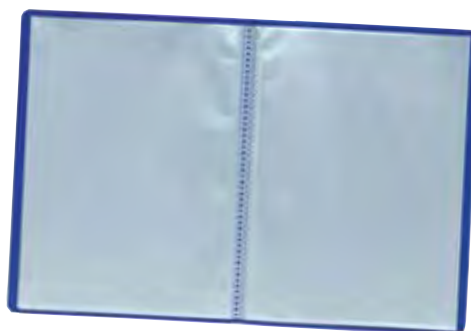
- PVC korice
- plave i crvene boje
- za format A4



Broj uložaka			Pakiranje
10	000030479	000030480	25
20	000030481	000030482	20





Esselte

Listovi uložni

- proizvedeni od kartona 160g/m²
- univerzalna perforacija
- pregrade u bojama
- pregrada 5
- format: A4
- dimenzija: 225x297 mm
- pakiranje: 20
- šifra: **000013337**



Esselte

Listovi uložni

- proizvedeni od kartona 160g/m²
- univerzalna perforacija
- pregrade u bojama
- pregrada 6
- format: A4
- dimenzija: 225x297 mm
- pakiranje: 20
- šifra: **000000296**



Esselte

Listovi uložni

- proizvedeni od kartona 160g/m²
- univerzalna perforacija
- pregrade u bojama
- pregrada 12
- format: A4
- dimenzija: 225x297 mm
- pakiranje: 10
- šifra: **000000303**



DONAU

Listovi uložni

- od polipropilena 120 mikrona
- univerzalna perforacija
- pregrade u bojama
- pregrada 10
- format: A4
- dimenzija: 225x297 mm
- pakiranje: 25
- šifra: **000018665**



Esselte

Listovi uložni

- 160 g/m² karton
- univerzalna perforacija
- pregrade u bojama
- pregrada 12
- format: A4
- pakiranje: 10
- šifra: **000001205**



Office Line

Listovi uložni

- kartonski
- univerzalna perforacija
- pregrade u bojama
- pregrada 6
- format: A4
- pakiranje: 20
- šifra: **000001818**

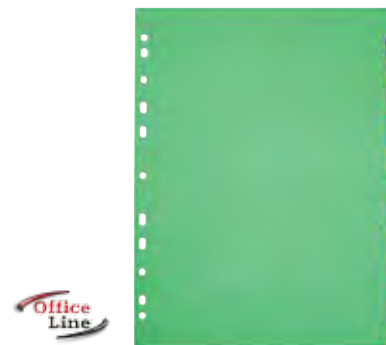

Office Line

Listovi uložni

- kartonski
- univerzalna perforacija
- pregrade u bojama
- pregrada 12
- format: A4
- pakiranje: 10
- šifra: **000001820**



DONAU

Listovi uložni

- od polipropilena 120 mikrona
- univerzalna perforacija
- pregrade u bojama
- pregrade od 1-5
- format: A4
- dimenzija: 230x297 mm
- pakiranje: 25
- šifra: **000024016**



DONAU

Listovi uložni

- od polipropilena 120 mikrona
- univerzalna perforacija
- pregrade u bojama
- pregrade od 1-31
- format: A4
- dimenzija: 230x297 mm
- pakiranje: 10
- šifra: **000024018**



DONAU

Listovi uložni

- od polipropilena 120 mikrona
- univerzalna perforacija
- pregrade u bojama
- pregrade od A-Z
- format: A4
- dimenzija: 230x297 mm
- pakiranje: 20
- šifra: **000024019**

**Listovi uložni**

- proizvedeni od polipropilena 120 mikrona
- univerzalna perforacija
- pregrade u sivoj boji
- pregrade od 1-12
- format: A4
- dimenzija: 225x297 mm
- pakiranje: 10
- šifra: **000007915**

**Listovi uložni**

- proizvedeni od polipropilena 120 mikrona
- univerzalna perforacija
- pregrade u sivoj boji
- pregrade od A-Z
- format: A4
- dimenzija: 225x297 mm
- pakiranje: 10
- šifra: **000000290**

**fornax****Listovi uložni**

- kartonska pregrada od A-Ž
- 2 rupe
- karton 200g/m2
- set od 25 listova
- boje: plava i žuta
- dimenzija: 225x172 mm
- šifra: **000030063**

**fornax****Listovi uložni**

- kartonska pregrada
- 2 rupe
- karton 240g/m2
- set od 100 listova
- sort boje
- dimenzija: 235x105 mm
- šifra: **000029887**

**Listovi uložni**

- od polipropilena
- univerzalna perforacija
- pregrade u sivoj boji
- format: A4
- dimenzija: 225x295 mm



Šifra	Oznake pregrada	Pakiranje
000033475	1-10	50
000033477	1-12	40
000033476	1-31	20
000033474	A-Z	50

fornax**Listovi uložni**

- od polipropilena
- univerzalna perforacija
- pregrade u sivoj boji
- oznake pregrada: A-Ž
- format: A4
- dimenzija: 225x295 mm
- pakiranje: 15
- šifra: **000013556**



MAPE POTPISNE

**LEITZ****Mapa potpisna**

- s prozorom za naljepnicu
- listovi su od čvrstog kartona
- boja plava
- pregrada 10
- dimenzija: 240x340 mm
- pakiranje: 1
- šifra: **000000263**

**LEITZ****Mapa potpisna**

- s prozorom za naljepnicu
- listovi su od čvrstog kartona
- boja plava
- pregrada 20
- dimenzija: 240x340 mm
- pakiranje: 1
- šifra: **000007906**

**Mapa potpisna**

- s prozorom za naljepnicu
- listovi su od čvrstog kartona debljine: 1,9 mm
- boja plava i crna
- pregrada 20
- dimenzija: 245x343 mm
- pakiranje: 5



- **000024013**
- **000021692**

MAPE ZA PROJEKTE

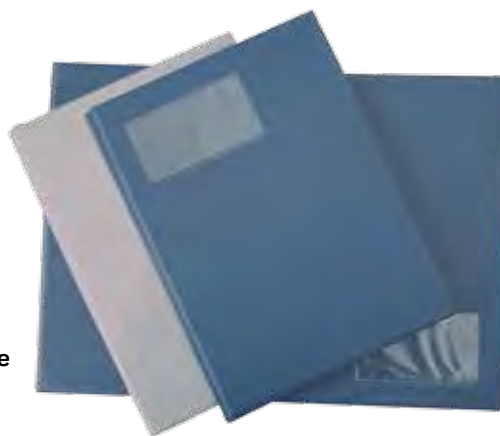

Mapa za projekte

- PVC mapa
- s džepićem
- pakiranje: 10

Šifra	Format	Boja
000014266	A3	
000000332	A3	
000012906	A4	
000002780	A4	

TUBE ZA PROJEKTE



Tuba za projekte

- PVC tuba crne boje s poklopcima u raznim bojama
- s podesivim remenom
- za veličine do A2
- pakiranje: 3
- šifra: **000019790**



Tuba za projekte

- PVC tuba crne boje s poklopcima u raznim bojama
- čep s navojem
- s podesivim remenom
- promjer: 80 mm
- dužina: 50-110 cm
- pakiranje: 12
- šifra: **000019892**



JAMSTVENIK, ETIKETE NOTARSKE



Jamstvenik

- trobojni
- 12 niti

Šifra	Dužina (m)	Pakiranje
000017726	50	10
000011305	100	10
000013331	400	10
000013784	1000	8

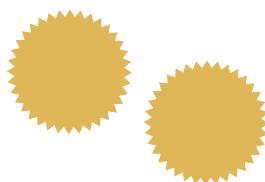

Etikete notarske

- zlatne boje
- služe za sigurnosno označavanje dokumenata
- pakiranje: 300 naljepnica u roli
- šifra: **000011805**



Eurokarbon**Vosak pečatni**

- za vruće pečačenje
- pakiranje: 10
- šifra: **000009474**

Eurokarbon**Vosak pečatni**

- za hladno pečačenje
- pakiranje: 10
- šifra: **000005762**

ETUI

Etui za dokumente

- transparentni
- raznih dimenzija i oblika za različite dokumente

Šifra	Opis
000009079	trodjelni
000012751	trodjelni manji
000001647	za štednu knjižicu
000003950	dvodjelni za vozačku dozvolu i osobnu iskaznicu
000001803	za zdravstvenu knjižicu
000011843	za osobne dokumente
000011394	za đačku knjižicu

**Etui za vizit karte Omiplast**

- s adresarom
- kožna korica
- kapacitet: 80 vizit kartica
- dimenzija: 120x277 mm
- pakiranje: 10
- šifra: **000011841**

**Etui za vizit karte Omiplast**

- kožna korica
- kapacitet: 80 vizit kartica
- dimenzija: 120x265 mm
- pakiranje: 10
- šifra: **000000174**

**Etui za vizit karte**

- plastificirane korice
- kapacitet: 150 vizit kartica
- mehanizam s 4 prstena
- dimenzija: 171x319 mm
- boja: crna
- pakiranje: 10
- šifra: **000024002**

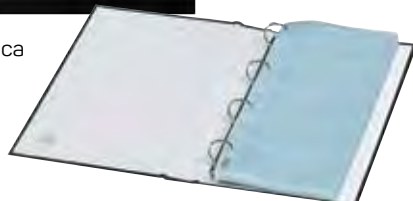
**Etui za vizit karte s indexom**

- plastificirane korice
- kapacitet: 210 vizit kartica
- mehanizam s 4 prstena
- dimenzija: 171x319 mm
- boja: crna
- pakiranje: 10
- šifra: **000024003**

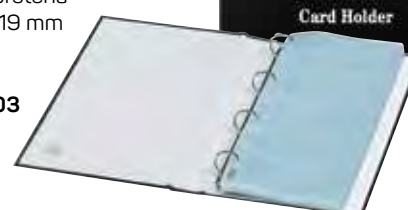

OSVIJEŽENJE U BOJI

Colour'Ice

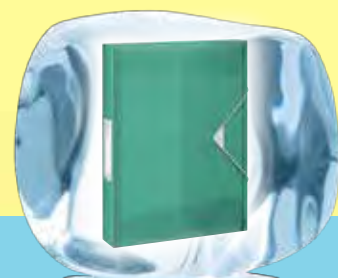
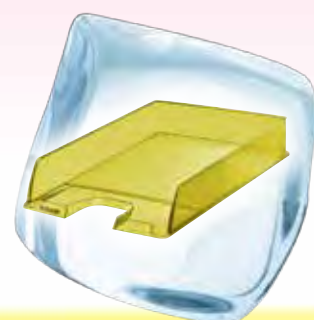

Esselte Colour'Ice

Želite svježiji dizajn na vašem stolu? Odaberite i kombinirajte 18 super proizvoda u četiri ledene boje. Colour'Ice - osviježenje u boji.





Ploča piši-briši Barracuda

- magnetna ploča na stalku s točkicama
- posebna površina koja se brzo suši nakon brisanja
- dimenzija: 100 x 70 cm
- pakiranje: 1
- šifra: **000013940**



Ploča piši-briši Shark

- magnetna ploča na teleskopskom stalku
- posebna površina koja se brzo suši nakon brisanja
- teleskopski stalak idealan je za neravne podove
- dolazi s markerom za pisanje
- dimenzija: 100 x 70 cm
- pakiranje: 1
- šifra: **000013941**



Ploča piši-briši Pirahna

- magnetna ploča na stalku s točkicama
- posebna površina koja se brzo suši nakon brisanja
- s ravnalom za precizno crtanje i pisanje
- podesiva kutija za makere i magnete
- ima dodatak za objesiti papir
- dolazi s markerom za pisanje
- dimenzija: 100 x 70 cm
- pakiranje: 1
- šifra: **000015017**



Ploča piši-briši Nautila

- ploča na teleskopskom stalku
- posebna površina koja se brzo suši nakon brisanja
- teleskopski stalak idealan je za neravne podove
- dolazi s markerom za pisanje
- dimenzija: 100 x 70 cm
- pakiranje: 1
- šifra: **000011217**



FLIPCHART MARKERI

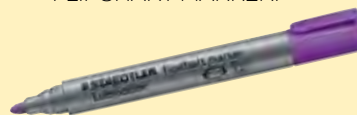

VIDJETI NA STR. 171

Ploča piši-briši

- ploča na stalku po kojoj se može pisati i brisati
- uz ploču dolazi i flipchart marker
- dostupna u dvije veličine
- pakiranje: 1

Šifra	Dimenzija (cm)
000014203	60 x 90
000014204	70 x 103



Ploča piši-briši dvostrana

- ploča na stalku po kojoj se može na obje strane pisati i brisati
- dostupna u dvije veličine
- pakiranje: 1

Šifra	Dimenzija (cm)
000014202	60 x 90
000014002	90 x 120





nobo

Ploča piši-briši Diamond

- mat bijela izrađena od kaljenog stakla
- magnetna staklena površina pruža glatko pisanje i lako se čisti
- cijelom dužinom je ladica za markere
- mobilna baza s 5 kotača koja se mogu i zaključiti
- uz ploču dolaze 2 magneta i 2 kukice za flipchart blokove
- dimenzija: 100 x 70 cm
- pakiranje: 1
- šifra: **000028069**



nobo

Ploča piši-briši Diamond

- nudi visoku kvalitetu i modernu eleganciju
- mat bijela izrađena od kaljenog stakla
- 360° obostrana
- magnetna staklena površina pruža glatko pisanje i lako se čisti
- cijelom dužinom je ladica za markere
- stabilnost joj daju 4 kotača koja se mogu i zaključiti
- uz ploču dolaze 2 magneta i 2 kukice za flipchart blokove
- dimenzija: 120 x 90 cm
- pakiranje: 1
- šifra: **000028068**



ReXel

Ploča piši-briši

- mat bijela izrađena od kaljenog stakla
- uz ploču dolaze 1 marker s brisačem
- dimenzija: 31,8 x 21,6 cm
- pakiranje: 1
- šifra: **000030974**



WHITEBOARD MARKERI



VIDJETI NA STR. 172

Sprej za ploče Data Flash

- za brisanje bijelih ploča
- količina: 250 ml
- pakiranje: 12
- šifra: **000012134**

**fornax****Sprej za ploče**

- bezalkoholna formula
- za temeljito čišćenje bijelih ploča od tinte, prljavštine i ostalih mrlja
- ne ostavlja tragove
- količina: 250 ml
- pakiranje: 1
- šifra: **000022165**





nobo

Ploča piši-briši Elipse Steel

- magnetna lakirana čelična ploča
- s aluminijским okvirom
- dolazi s markerom za pisanje i podlogom za držanje markera
- dostupna u 3 veličine
- pakiranje: 1

Šifra	Dimenzija (cm)
000013943	45 x 60
000013944	60 x 90
000013945	90 x 120

**Ploča piši-briši**

- jednostrana magnetna s drvenim okvirom
- uz ploču dolaze 4 magneta u boji i crni marker sa brisačem
- dimenzija: 40x60 cm
- pakiranje: 1
- šifra: **000014199**

**Ploča piši-briši**

- s aluminijским okvirom
- pakiranje: 1

Šifra	Dimenzija (cm)
000003427	30 x 45
000005590	45 x 60
000001707	60 x 90
000003428	120 x 90
000003429	120 x 180
000003430	120 x 240



Quartet®

Ploča piši-briši

- magnetna ploča bez okvira
- dimenzija: 36x36 cm
- crne boje
- uz ploču dolaze: 2 magneta, ljepljiva traka i marker
- pakiranje: 1
- šifra: **000025592**





Quartet®

Ploča piši-briši

- magnetna ploča
- dimenzija: 21,6x28 cm
- dostupne boje okvira: plava, roza, crna i zelena
- uz ploču dolaze: magneti, ljepljiva traka, marker i brisač
- pakiranje: 1
- šifra: **000025594**



Quartet®

Ploča piši-briši

- magnetna
- bijela s rubom sort boja
- bez okvira
- uz ploču dolaze: 2 magneti, marker i pribor za montažu
- dimenzija: 30x30 cm
- šifra: **000026643**





Quartet®

Ploča tjedni planer

- kombinacija ploče piši-briši i pluto ploče
- srebreni aluminijski okvir
- uz ploču dolaze magneti, marker s brisačem i pribor za montažu
- dimenzija: 58,5x19 cm
- pakiranje: 1
- šifra: **000026646**

Quartet®

Ploča mjesečni planer

- kombinacija ploče piši-briši i pluto ploče
- srebreni aluminijski okvir
- uz ploču dolaze magneti, marker s brisačem i pribor za montažu
- dimenzija: 58,5x43 cm
- pakiranje: 1
- šifra: **000032244**

Quartet®

Ploča piši-briši

- magnetna ploča s pjenastim jastučićima za pričvršćivanje obavijesti i odjeljkom za markere
- modernog dizajna bez okvira
- srebrena boja
- dimenzija: 61x39 cm
- uz ploču dolaze: magneti, ljepljiva traka i 4 markera
- pakiranje: 1
- šifra: **000025595**



OKVIRI



Aluminijski okvir

- zidni aluminijski okvir za postere i reklame
- može se koristiti horizontalno i vertikalno
- PVC korica štiti reklamu ili poster od prljanja
- dolazi za pričvršćaćima za zid
- pakiranje: 1

Šifra	Dimenzija (cm)	Format
000029036	84 x 119	A0
000027746	59,4 x 84	A1
000021183	50 x 70	B2
000013952	42 x 59,4	A2
000013953	29,7 x 42	A3
000013954	21 x 29,7	A4



NOVO

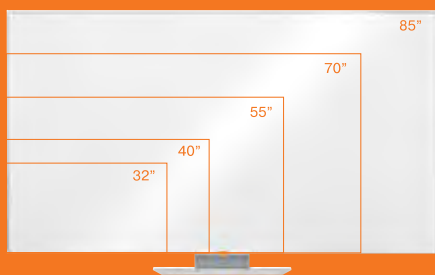

Format širokog zaslona

Povećajte površinu za pisanje i pristupačnost. TV formati širokog zaslona olakšavaju odabir prave dimenzije ploče.



Tanak okvir

Okružen suvremenim, tankim i nenametljivim okvirom koji maksimizira prostor za pisanje na ploči.



Ladica za pribor

Prostorna ladica za pribor smještena je ispod ploče i ne pokriva površinu ploče.

Nobo široki zaslون. Proširite svoje razmišljanje

Nova linija Nobo ploča omogućuje vam i vašem timu pisanje na širokom zaslonu. Rubovi su tanji kako bi povećali prostor za pisanje i novi formati čine jih još dostupnijim. Montaža na zid ne može biti lakša s našim novim InvisaMount™ sistemom.

www.nobo-europe.com

nobo[®]
be clear

Bi-Office**A-stalak**

- idealan za postere, reklame i oglase
- za formate A1, obostrana
- s uskim aluminijским okvirom
- prozirna plastična folija štiti reklamu od prljanja
- jednostavna i brza montaža
- dimenzija: 63,5 x 109 cm
- dimenzija ploče: 59,4 x 84,1 cm
- pakiranje: 1
- šifra: **000032604**

**A-stalak**

- idealan za postere, reklame i oglase
- za unutarnju i vanjsku upotrebu
- obostrana
- može se koristiti i kao ploča piši-briši
- dvostrani aluminijски stalak s profilom od 32 mm i kromiranim kutevima
- s anti-reflektirajućom PVC folijom koja štiti reklamu od prljanja
- dimenzija ploče: 50 x 70 cm
- pakiranje: 1
- šifra: **000033400**

**A-stalak**

- idealan za postere, reklame i oglase
- za unutarnju i vanjsku upotrebu
- obostrana
- može se koristiti i kao ploča piši-briši
- dvostrani aluminijски stalak s profilom od 32 mm i kromiranim kutevima
- s anti-reflektirajućom PVC folijom koja štiti reklamu od prljanja
- dimenzija ploče: 70 x 100 cm
- pakiranje: 1
- šifra: **000033401**

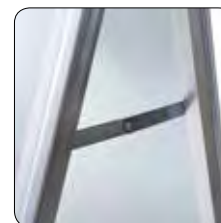

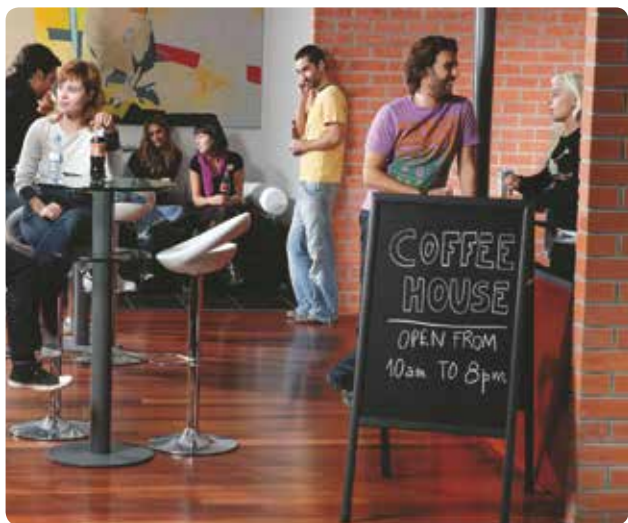
**Bi-Office****A-stalak**

- idealan za restorane, kantine i trgovine
- obostrana crna ploča za pisanje kredom
- drveni okvir
- dimenzija: 60 x 90 cm
- pakiranje: 1
- šifra: **000030679**



PRIBORI ZA MAGNETNE PLOČE

**fornax****Blokovi za prezentacijske ploče**

- papir 80 g/m²
- perforacija na vrhu za kidanje listova
- pakiranje PVC vrećica

Šifra	Dimenzija (cm)	Broj listova	Pakiranje
000016971	58 x 85,5	50	1/1
000016972	58 x 85,5	20	5/1
000016973	68 x 97	50	1/1
000016974	68 x 97	20	5/1

Magneti za ploču

- za ploče piši briši
- okrugli u raznim bojama

Šifra	Ø	Pak./kom.	Pakiranje
000004653	20	8/1	36
000007796	30	12/1	24
000007347	30	6/1	24

**fornax****Magneti za ploču**

- za ploče piši briši
- okrugli u raznim bojama
- blister pakiranje

Šifra	Ø	Pak./kom.	Pakiranje
000021415	20	6/1	50
000021416	30	5/1	50

**nobo****Brisač za ploče**

- magnetni
- za suho brisanje staklenih ploča
- sive boje, ergonomskog oblika
- pakiranje: 1
- šifra: **000030491**

**nobo****Brisač za ploče Diamond**

- magnetni
- za suho brisanje staklenih ploča
- sive boje, ergonomskog oblika
- pakiranje: 1
- šifra: **000028067**





Brisač za ploče

- za suho brisanje bijelih ploča
- dimenzija: 6,5x15 cm
- PVC držač plave boje
- pakiranje: 5
- šifra: **000015780**



Brisač za ploče MER-2P

- magnetni
- za suho brisanje bijelih ploča
- dimenzija: 5,5x14,5x3,5 cm
- PVC držač crne ili sive boje
- pakiranje: 1
- šifra: **000012269**



Rezervni uložak za brisač MER-2P

- dimenzija: 5x13,5 cm
- boja: siva
- set od 12 komada
- pakiranje: 1
- šifra: **000032831**



Brisač za ploče R-882 Data zone

- za suho brisanje bijelih ploča
- PVC držač ergonomskog oblika
- u raznim bojama
- pakiranje: 12
- šifra: **000004654**



Brisač za ploče ER 1202/1252

- za suho brisanje bijelih ploča
- PVC držač u raznim bojama
- pakiranje: 12
- šifra: **000002192**

PLOČE PLUTO

fornax

Ploča pluto

- s drvenim okvirom
- raznih dimenzija
- pakiranje: 1

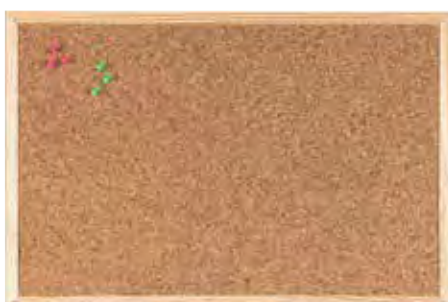

Šifra	Dimenzija (cm)
000014196	30x40
000003761	40x60
000013966	45x60
000014197	60x80
000002191	60x90
000024426	90x120

fornax

Ploča pluto

- s aluminijskim okvirom
- pakiranje: 1

Šifra	Opis	Dimenzija (cm)
000014198	dvostrana	60x90
000005504	jednostrana	120x90



**Ploča dupla**

- s drvenim okvirom
- pogodna za ostavljanje poruka
- polovica ploče je pluto, a polovica bijela piši-briši ploča
- dimenzija: 40 x 60 cm
- pakiranje: 1
- šifra: **000003762**

ČAVLIĆI

fornax**Čavlići za pluto ploče**

- u raznim bojama
- blister pakiranje
- pakiranje: 50/1
- šifra: **000021419**

**Čavlići za pluto ploče**

- u raznim bojama
- pakiranje: 25/1
- šifra: **000006264**



PLATNA ZA PROJEKCIJE

**Platno za projekciju**

- sa stalkom
- s mat površinom i crnim okvirom
- idealna za digitalne projektore
- platno se može lako urolati bez oštećenja
- pakiranje: 1

Šifra	Dimenzija (cm)
000013949	150 x 113.8
000013950	175 x 132.5
000013951	200 x 151.3

**Platno za projekciju**

- s mat površinom i crnim okvirom
- idealna za digitalne projektore
- platno se može lako urolati bez oštećenja
- pakiranje: 1

Šifra	Dimenzija (cm)
000013946	150 x 113.8
000013947	175 x 132.5
000013948	200 x 151.3
000013267	240 x 181.3

nobo

**Laserski pokazivač**

- modernog dizajna
- malih dimenzija
- jednostavan za upotrebu
- koristi bateriju CR2302
- laserska udaljenost 200 m
- pakiranje: 1
- šifra: **000012233**

nobo

Laserski pokazivač 4 u 1

- multifunkcionalni
- u obliku olovke
- laserski pokazivač služi i kao: PDA igla za zapisivanje, svjetiljka i kemijska olovka
- koristi bateriju LR41
- laserska udaljenost 100 m
- pakiranje: 1
- šifra: **000011527**



Genius

**Laserski pokazivač**

- jednostavan za upotrebu
- sadrži tipku stranice gore/dolje i ESC tipku
- wireless: 2.4 GHz
- koristi bateriju: 2 x AAA
- laserska udaljenost 10 m
- dimenzija: 105 x 38 x 18 mm
- pakiranje: 1
- šifra: **000025882**

fornax**Folija za grafoskop**

- transparentna folija
- idealna za kolor kopiranje i laserski ispis
- debljina folije: 0.100 mm
- format A4
- pakiranje: 100 listova
- šifra: **000023016**



OBJAŠNJENJE IKONA

**100% Anti Jam**

Plastifikator je 100% siguran protiv zaglava kada se koristi s odgovarajućim folijama. Poseban način ultra niskog trenja olakšava prolaz dokumenta kroz valjke, te sprečava plastifikator od zaglava.

**Automatsko gašenje**

Smanjuje potrošnju energije isključivanjem uređaja nakon određenog razdoblja neaktivnosti za maksimalnu sigurnost čak i u slučaju da ga zaboravite isključiti.

**HeatGuard - Sigurno na dodir**

Patentirani sigurnosni sustav koji smanjuje površinsku temperaturu i do 35%.

**Hot Swap**

Ne trebate čekati za hlađenje ili grijanje stroja, nego možete odmah prebaciti na postavke za folije različitih debljina, plastifikator je uvijek spreman za uporabu.

**AutoLam**

Sustav automatski otkriva debljinu folije za plastifikaciju, te odmah namješta postavke na najbolju kombinaciju brzine i temperature plastifikacije.





Plastifikator Fusion 1000L A4

- služi za plastifikaciju od veličine iskaznica i dokumenata do formata A4
- vrijeme zagrijavanja 5 minuta
- dizajniran za folije za plastifikaciju do 2 x 75 mikrona (150 ukupno)
- za kuću i male urede
- pakiranje: 1
- šifra: **000021184**



Plastifikator Inspire A4

- služi za plastifikaciju od veličine iskaznica i dokumenata do formata A4
- dizajniran za vrećice 2 x 75 mikrona (150 ukupno)
- moderan dizajn i male dimenzije
- kompaktan za svaki ured
- pakiranje: 1
- šifra: **000016186**



Fellowes

Plastifikator Lunar A4



- služi za plastifikaciju fotografija i papira do formata A4
- vrijeme zagrijavanja 6 minuta
- dizajniran za folije za plastifikaciju do 2 x 80 mikrona (160 ukupno)
- brzina plastifikacije 30 cm/min
- tehnologija protiv zaglavlivanja folije
- pakiranje: 1
- šifra: **000021644**



Fellowes



Plastifikator Callbre A4

- služi za plastifikaciju fotografija i papira do formata A4
- vrijeme zagrijavanja 1 minuta
- dizajniran za folije za plastifikaciju do 2 x 125 mikrona (250 ukupno)
- brzina plastifikacije 50 cm/min
- automatski se gasi nakon 30 min. nekorištenja
- HotSwap tehnologija omogućuje da se postavke odmah prebacuju na različite debljine folija
- patentirani sigurnosni sustav smanjenja površinske temperature do 35%
- pakiranje: 1
- šifra: **000032050**



ŠTO PLASTIFICIRATI?

Plastifikacija se može koristiti za širok spektar aktivnosti, a za različite vrste dokumenata, i kod kuće i na poslu.



NA POSLU

- Informativne poruke
- Vanjske poruke
- Prezentacijski materijali
- Meniji
- Popisi
- Promotivni materijali
- Posjetnice i značke



KOD KUĆE

- Čestitke
- Poslovne kartice
- Plakati
- Oznake za prtljagu
- Fotografije
- Hobi
- Dječje crteže





Fellowes



Plastifikator L125 A4

- služi za plastifikaciju fotografija i papira do formata A4
- vrijeme zagrijavanja 4 minute
- dizajniran za folije za plastifikaciju do 2 x 125 mikrona (250 ukupno)
- brzina plastifikacije 30 cm/min
- automatski se gasi nakon 30 min. nekorisćenja
- pakiranje: 1
- šifra: **000031203**



Fellowes

Plastifikator Lunar+ A4

- služi za plastifikaciju fotografija i papira do formata A4
- vrijeme zagrijavanja 4 minute
- dizajniran za folije za plastifikaciju do 2 x 125 mikrona (250 ukupno)
- brzina plastifikacije 30 cm/min
- pakiranje: 1
- šifra: **000033039**



LEITZ

LAM

Plastifikator iLAM HOME_OFFICE A4

- služi za plastifikaciju dokumenata do formata A4
- vrijeme zagrijavanja 3 minute
- za plastifikaciju A4 dokumenta potrebno je 60 sec.
- jednostavan za upotrebu
- dizajniran za folije za plastifikaciju od 2 x 80 do 2 x 125 mikrona
- pakiranje: 1
- šifra: **000031904**



GBC

Plastifikator Fusion 1100L A4

- služi za plastifikaciju od veličine iskaznica i dokumenata do formata A4
- vrijeme zagrijavanja 4 minute
- dizajniran za folije za plastifikaciju do 2 x 125 mikrona (250 ukupno)
- automatsko ili ručno podešavanje temperature
- automatski se gasi nakon 30 min. nekorisćenja
- pakiranje: 1
- šifra: **000021186**



GBC

Plastifikator Fusion 3000L A4

- služi za plastifikaciju od veličine iskaznica i dokumenata do formata A4
- vrijeme zagrijavanja 1.5 minuta
- dizajniran za folije za plastifikaciju do 2 x 125 mikrona (250 ukupno)
- automatsko ili ručno podešavanje temperature
- automatski se gasi nakon 30 min. nekorisćenja
- s izlaznom ladicom
- pakiranje: 1
- šifra: **000021188**



Plastifikator Inspire A3

- služi za plastifikaciju od veličine iskaznica i dokumenata do formata A3
- dizajniran za vrećice 2 x 75 mikrona (150 ukupno)
- moderan dizajn i male dimenzije
- kompaktan za svaki ured
- pakiranje: 1
- šifra: **000016185**



Plastifikator Fusion 1000L A3

- služi za plastifikaciju od veličine iskaznica i dokumenata do formata A3
- vrijeme zagrijavanja 5 minuta
- dizajniran za folije za plastifikaciju do 2 x 75 mikrona (150 ukupno)
- za kuću i male urede
- pakiranje: 1
- šifra: **000021185**

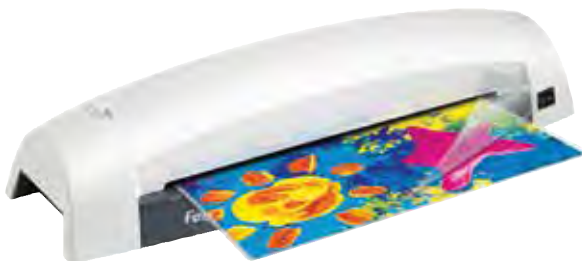

Fellowes



Plastifikator Lunar A3

- služi za plastifikaciju papira do formata A3
- vrijeme zagrijavanja 6 minuta
- dizajniran za folije za plastifikaciju do 2 x 80 mikrona (160 ukupno)
- brzina plastifikacije 30 cm/min
- tehnologija protiv zaglavlivanja folije
- pakiranje: 1
- šifra: **000021645**



Plastifikator Fusion 3000L A3

- služi za plastifikaciju dokumenata do formata A3
- vrijeme zagrijavanja 1.5 minuta
- dizajniran za folije za plastifikaciju do 2 x 125 mikrona (250 ukupno)
- automatsko ili ručno podešavanje temperature
- automatski se gasi nakon 30 min. nekoristenja
- s izlaznom ladicom
- pakiranje: 1
- šifra: **000021189**



Plastifikator Fusion 1100L A3

- služi za plastifikaciju dokumenata do formata A3
- vrijeme zagrijavanja 4 minute
- dizajniran za folije za plastifikaciju do 2 x 125 mikrona (250 ukupno)
- automatsko ili ručno podešavanje temperature
- automatski se gasi nakon 30 min. nekoristenja
- pakiranje: 1
- šifra: **000021187**



Fellowes



Plastifikator Saturn A3

- služi za plastifikaciju dokumenata do formata A3
- vrijeme zagrijavanja 1 minuta
- dizajniran za folije za plastifikaciju do 2 x 125 mikrona (250 ukupno)
- brzina plastifikacije 30 cm/min
- automatski se gasi nakon 30 min. nekoristenja
- tehnologija protiv zaglavlivanja folije
- pakiranje: 1
- šifra: **000025479**



Fellowes

Plastifikator Lunar+ A3

- služi za plastifikaciju fotografija i papira do formata A3
- vrijeme zagrijavanja 4 minute
- dizajniran za folije za plastifikaciju do 2 x 125 mikrona (250 ukupno)
- brzina plastifikacije 30 cm/min
- pakiranje: 1
- šifra: **000033040**



Fellowes



Plastifikator L125 A3

- služi za plastifikaciju fotografija i papira do formata A3
- vrijeme zagrijavanja 4 minute
- dizajniran za folije za plastifikaciju do 2 x 125 mikrona (250 ukupno)
- brzina plastifikacije 30 cm/min
- automatski se gasi nakon 30 min. nekorisćenja
- pakiranje: 1
- šifra: **000033049**



Plastifikator iLAM HOME_OFFICE A3

- služi za plastifikaciju dokumenata do formata A4
- vrijeme zagrijavanja 3 minute
- za plastifikaciju A4 dokumenta potrebno je 60 sec.
- jednostavan za upotrebu
- dizajniran za folije za plastifikaciju od 80 do 125 mikrona
- pakiranje: 1
- šifra: **000031277**



Plastifikator Fusion 3100L A3

- služi za plastifikaciju dokumenata do formata A3
- vrijeme zagrijavanja 1 minuta
- dizajniran za folije za plastifikaciju do 2 x 175 mikrona (350 ukupno)
- automatsko ili ručno podešavanje temperature
- automatski se gasi nakon 30 min. nekorisćenja
- sistem s 4 valjka i izlaznom ladicom
- pakiranje: 1
- šifra: **000021190**



Fellowes



Plastifikator Jupiter 2 A3

- služi za plastifikaciju dokumenata do formata A3
- vrijeme zagrijavanja 1 minuta
- dizajniran za folije za plastifikaciju do 2 x 250 mikrona (500 ukupno)
- brzina plastifikacije 75 cm/min
- automatski se gasi nakon 30 min. nekorisćenja
- AutoSense funkcija detektira debljinu folije i samostalno podešava program plastifikacije
- tehnologija protiv zaglavlivanja folije
- pakiranje: 1
- šifra: **000024815**





Plastifikator Fusion Plus 6000L A3

- služi za plastifikaciju od veličine iskaznica i dokumenata do formata A3
- vrijeme zagrijavanja 1 minuta
- dizajniran za folije za plastifikaciju do 2 x 250 mikrona (500 ukupno)
- inteligentni ulazni senzori otkrivaju debljinu vrećice i sadržaja te automatski prilagođavaju brzinu prolaza
- brzina 1200 mm/min
- auto okretni pretvarač sprječava pogrešno uvlačenje vrećice ili zaglavljivanje
- pakiranje: 1
- šifra: **000033199**



Plastifikator Fusion 5100L A3

- služi za plastifikaciju od veličine iskaznica i dokumenata do formata A3
- vrijeme zagrijavanja 1 minuta
- dizajniran za folije za plastifikaciju do 2 x 250 mikrona (500 ukupno)
- jednostavne postavke na LCD zaslonu
- automatsko ili ručno podešavanje temperature
- automatski se gasi nakon 30 min. nekorisćenja
- sistem s 4 valjka i izlaznom ladicom
- pakiranje: 1
- šifra: **000021192**

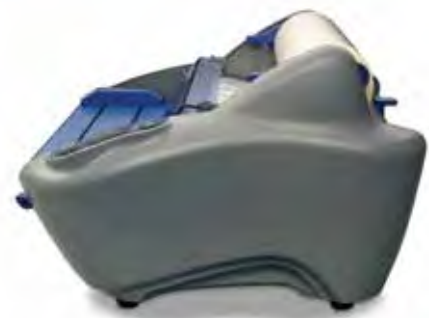

Plastifikator 35 EZload

- EZload tehnologija omogućuje nepravilno odvijanje plastifikacija
- vrijeme zagrijavanja 1 minuta
- plastificira sve, od malih kartica i zastavica, do postera 150 m dužine
- koristi folije za plastifikaciju u roli od 2 x 42.5 mikrona (85 ukupno) do 2 x 250 mikrona (500 ukupno)
- plastificira 1 metar u minuti
- pakiranje: 1
- šifra: **000010108**

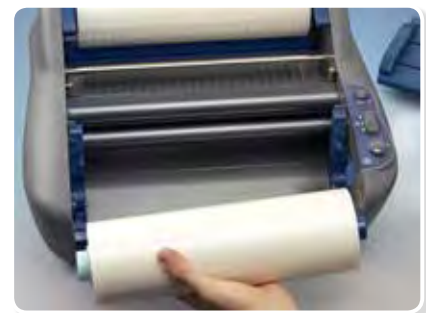



Folija za plastifikaciju

- raznih formata vrhunske kvalitete
- za plastifikaciju korica, letaka, jelovnika, iskaznica...
- dostupna kao gloss i matt
- pakiranje: 100 kom.

Šifra	Format	Opis	Debljina (mic)
00007788	54 x 86	gloss	125 x 2
00007787	59 x 83	gloss	125 x 2
00007789	60 x 90	gloss	125 x 2
00007758	65 x 95	gloss	125 x 2
00007757	83 x 113	gloss	125 x 2
000014352	A5	gloss	75 x 2
000014353	A5	gloss	125 x 2
000007755	A4	gloss	75 x 2
000007756	A4	gloss	125 x 2
000008680	A4	matt	100 x 2
000000533	A4	gloss, samoljepljiva	125 x 2
000007786	A3	gloss	75 x 2
000000528	A3	matt	125 x 2



fornax

Folija za plastifikaciju

- sjajna folija izuzetno dobre kvalitete
- pakiranje: 100 kom.

Šifra	Format	Opis	Debljina (mic)
000016182	65 x 95 mm	gloss	125 x 2
000016178	A4	gloss	80 x 2
000016179	A4	gloss	125 x 2
000016180	A3	gloss	80 x 2
000016181	A3	gloss	125 x 2



Folija za plastifikaciju u roli EZload

- posebna folija u roli za plastifikator EZload GBC
- pakiranje: 2

Šifra	Format (mm x m)	Opis	Debljina (mic)
000012492	305 x 60	gloss	125
000012491	305 x 75	gloss	75
000010916	305 x 75	matt	75
000011294	305 x 150	gloss	42.5
000011295	305 x 150	matt	42.5



Folija za plastifikaciju u roli

- vrhunske kvalitete
- za plastifikaciju korica, letaka, jelovnika...
- pakiranje: 2



Šifra	Format (mm x m)	Opis	Debljina (mic)
000010020	305 x 150	gloss	42.5
000010021	305 x 150	matt	42.5
000010193	330 x 150	gloss	38
000010195	330 x 150	matt	42.5



Aparat za spiralni uvez CombBind 100

- kapacitet bušenja: 9 listova (80 g/m²)
- uvezuje max. 160 listova koristeći PVC spiralu do 19 mm
- za format A4
- pakiranje: 1
- šifra: **000025497**



Podesiva bočna margina i neovisni mehanizam za bušenje



Fellowes

Aparat za spiralni uvez Star+ 150

- kapacitet bušenja: 12 listova (80 g/m²)
- uvezuje max. 150 listova koristeći PVC spiralu do 19 mm
- ergonomska ručka
- za format A4
- pakiranje: 1
- šifra: **000024810**



Aparat za spiralni uvez CombBind 110

- kapacitet bušenja: 12 listova (80 g/m²)
- uvezuje max. 195 listova koristeći PVC spiralu do 22 mm
- za format A4
- pakiranje: 1
- šifra: **000024069**



Fellowes

Aparat za spiralni uvez PulsarE 300

- električni aparat
- kapacitet bušenja: 15 listova (80 g/m²)
- uvezuje max. 300 listova koristeći PVC spiralu do 38 mm
- gumb za bušenje sa zaštitama od pregrijavanja
- za format A4
- pakiranje: 1
- šifra: **000024811**



Pulsar+ 300 i PulsarE 300



Česalj za spiralu pod kutem za lakše umetanje papira



Podesiva bočna margina za poravnanje listova



Ladica za odlaganje potrošnog materijala sa vodičem za odabir spirale



Ladica za otpad

Aparati za spiralni uvez (bušenje i uvez plastikom) dizajniran je za umjereno korištenje i idealan je za male i srednje velike urede. Vertikalno ulaganje dokumenata osigurava poravnanje pri bušenju. Podesiva vodilica ruba poravnava list točnije. Ladica za spirale i potrošni materijal s pomagalom za određivanje odgovarajuće spirale. Ladica za otpatke koja se automatski izbacuje kada se napuni. Vertikalno odlaganje uređaja.



Fellowes

Aparat za spiralni uvez Pulsar+ 300

- kapacitet bušenja: 17 listova (80 g/m²)
- uvezuje max. 300 listova koristeći PVC spiralu do 38 mm
- ergonomska ručka
- za format A4
- pakiranje: 1
- šifra: **000021648**



Aparat za spiralni uvez CombBind 200

- kapacitet bušenja: 20 listova (80 g/m²)
- uvezuje max. 330 listova koristeći PVC spiralnu do 38 mm
- za format A4
- pakiranje: 1
- šifra: **000024070**



Aparat za spiralni uvez Kombo

- kapacitet bušenja: 20 listova (80 g/m²)
- uvezuje max. 450 listova koristeći PVC spiralnu do 51 mm
- ima funkciju protiv zaglavljivanja papira
- za format A4
- pakiranje: 1
- šifra: **000007408**



Aparat za spiralni uvez Ibimatic C150 Pro

- kapacitet bušenja: 20 listova (80 g/m²)
- uvezuje max. 450 listova koristeći PVC spiralnu do 51 mm
- za format A4
- pakiranje: 1
- šifra: **000004449**



Fellowes

Aparat za spiralni uvez QuasarE 500

- električni aparat
- kapacitet bušenja: 25 listova (80 g/m²)
- uvezuje max. 500 listova koristeći PVC spiralnu do 51 mm
- gumb za bušenje sa zaštitama od pregrijavanja
- za format A4
- pakiranje: 1
- šifra: **000021650**

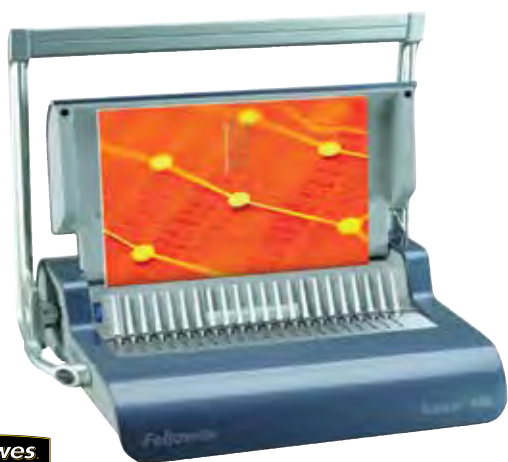

Fellowes

Aparat za spiralni uvez Quasar+ 500

- kapacitet bušenja: 22 listova (80 g/m²)
- uvezuje max. 500 listova koristeći PVC spiralnu do 51 mm
- ergonomska ručka
- za format A4
- pakiranje: 1
- šifra: **000021649**



PVC spirale

➔ VIDJETI NA STR. 303



Aparat za spiralni uvez CombBind C450E

- električni aparat
- kapacitet bušenja: 25 listova (80 g/m²)
- uvezuje max. 450 listova koristeći PVC spiralu od 51 mm
- za format A4
- pakiranje: 1
- šifra: **000016458**



Aparat za spiralni uvez C366

- kapacitet bušenja: 30 listova (80 g/m²)
- uvezuje max. 450 listova koristeći PVC spiralu od 51 mm
- ima funkciju auto-centriranja za savršeno bušenje
- za format A4
- pakiranje: 1
- šifra: **000014149**



Aparat za spiralni uvez WireBind W15

- kapacitet bušenja: 15 listova (80 g/m²)
- uvezuje max. 125 listova koristeći metalnu spiralu od 14 mm
- za format A4
- koristi metalnu spiralu 34
- pakiranje: 1
- šifra: **000012236**



Aparat za spiralni uvez WireBind W20

- kapacitet bušenja: 20 listova (80 g/m²)
- uvezuje max. 125 listova koristeći metalnu spiralu od 14 mm
- za format A4 i A5
- koristi metalnu spiralu 34
- pakiranje: 1
- šifra: **000012235**



Aparat za spiralni uvez WireBind W25E

- električni aparat
- kapacitet bušenja: 25 listova (80 g/m²)
- uvezuje max. 125 listova koristeći metalnu spiralu od 14 mm
- za format A4 i A5
- koristi metalnu spiralu 34
- pakiranje: 1
- šifra: **000019589**



Aparat za spiralni uvez MultiBind 212

- kapacitet bušenja: 12 listova (80 g/m²)
- uvezuje max. 145 listova koristeći PVC spiralu od 16 mm
- uvezuje max. 125 listova koristeći metalnu spiralu od 14 mm
- koristi metalnu spiralu 21
- za format A4
- pakiranje: 1
- šifra: **000014150**



Aparat za spiralni uvez MultiBind 320

- kapacitet bušenja: 20 listova (80 g/m²)
- uvezuje max. 450 listova koristeći PVC spiralu od 51 mm
- uvezuje max. 125 listova koristeći metalnu spiralu od 14 mm
- koristi metalnu spiralu 21
- za format A4 i A5
- pakiranje: 1
- šifra: **000013552**



Aparat za spiralni uvez MultiBind 208

- kapacitet bušenja: 8 listova (80 g/m²)
- uvezuje max. 125 listova koristeći PVC spiralu od 14 mm
- uvezuje max. 125 listova koristeći metalnu spiralu 21
- za format A4
- pakiranje: 1
- šifra: **000023187**



Aparat za spiralni uvez MultiBind 420

- aparat za spiralni uvez koji može koristiti: PVC spiralu, metalnu spiralu 34, metalnu spiralu 21 i klik spiralu
- kapacitet bušenja: 20 listova (80 g/m²) sa PVC spiralom
- uvezuje max. 450 listova koristeći PVC spiralu od 51 mm
- kapacitet bušenja: 12 listova (80 g/m²) s metalnom i klik spiralom
- uvezuje max. 125 listova koristeći metalnu spiralu od 14 mm
- uvezuje max. 145 listova koristeći klik spiralu od 16 mm
- za format A4 i A5
- pakiranje: 1
- šifra: **000015972**



Aparat za spiralni uvez MultiBind 230

- kapacitet bušenja: 30 listova (80 g/m²)
- uvezuje max. 450 listova koristeći PVC spiralu od 51 mm
- uvezuje max. 125 listova koristeći metalnu spiralu od 14 mm
- koristi metalnu spiralu 21
- za format A4 i A5
- pakiranje: 1
- šifra: **000014151**

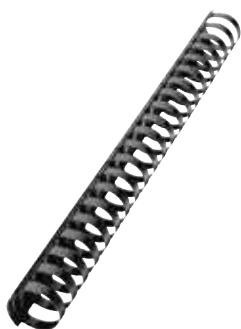

fornax

Spirala PVC

- za sve aparate za spiralni uvez koji koriste plastičnu spiralu



Širina (mm)	Kapacitet listova (80g/m ²)	Pakiranje	White	Black	Blue	Red
6	25	100/1	000013802	000013803	000014463	000014464
8	45	100/1	000013804	000013805	000014465	000014466
10	65	100/1	000013806	000013807	000014467	000014468
12	95	100/1	000013808	000013809	000014469	000014470
14	125	100/1	000013810	000013811	000014471	000014472
16	145	100/1	000013812	000013813	000014473	000014474
19	165	100/1	000013814	000013815	000032304	000032303
22	195	50/1	000013816	000013817	000032306	000032305
25	210	50/1	000032307	000032308	000032310	000032309
28	245	50/1	000013818	000013819	000032312	000032311
32	280	50/1	000013820	000013821	-	-
38	330	50/1	000013822	000013823	-	-
45	390	50/1	000013824	000013825	-	-
51	450	50/1	000013826	000013827	-	-

SPIRALE METALNE



Spirala metalna 34 3:1

- za sve aparate za spiralni uvez koji koriste metalnu spiralu 34
- 34 članka

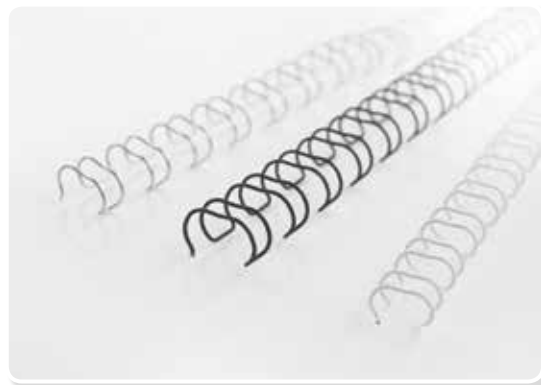

Širina (mm)	Kapacitet listova (80g/m ²)	Pakiranje	White	Black	Blue	Grey
6	55	100/1	-	000007569	-	000007573
		250/1	000009090	000011840	000009091	-
8	70	100/1	000007577	000007574	-	000007578
		250/1	-	000009092	-	-
9.5	85	100/1	000007582	000007579	-	000007583
12.5	115	100/1	000007586	000007584	-	000007587
		250/1	000009187	-	-	000019455
14	125	100/1	000007591	000007588	-	000007592
		250/1	-	-	-	000000711

SPIRALE METALNE

**Spirala metalna 21 2:1**

- za sve aparate za spiralni uvez koji koriste metalnu spiralu 21
- dostupna u srebrnoj boji
- 21 članak

Širina (mm)	Kapacitet listova (80g/m ²)	Pakiranje	Šifra
6	55	100/1	000016397
8	70	100/1	000016398
10	85	100/1	000016399
12	100	100/1	000016400
14	130	100/1	000016401

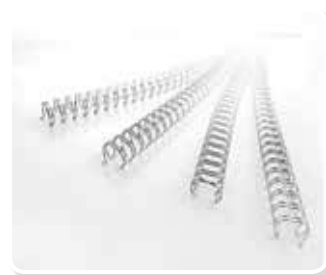
**Spirala metalna 23 2:1**

- za sve aparate za spiralni uvez koji koriste metalnu spiralu 23
- dostupna u srebrnoj boji
- 23 članak

Širina (mm)	Kapacitet listova (80g/m ²)	Pakiranje	Šifra
16	135	200/1	000015765
19	160	200/1	000015766
22	190	200/1	000015767

DRŽAČI PAPIRA

**Držać papira**

- PVC držać u plavoj boji
- idealan za brzo uvezivanje papira



Debljina (mm)	Kapacitet listova	Oznaka	Pakiranje	Šifra
3	15	D103	50	000014434
4	25	D104	50	000014433
6	35	D106	50	000014432
8	40	D108	50	
11	75	D111	30	000014436
16	90	D143	20	000014513

PREDLIST

fornax**Predlist za spiralno koričenje**

- transparentni u bojama
- pakiranje: 100 listova



Format	Debljina (mic)	Boja	Šifra
A4	150	transparent	000013791
A4	180	transparent	000013792
A4	180	crvena	000013793
A4	180	plava	000013794
A4	180	zelena	000013795
A4	180	žuta	000013796
A4	180	siva	000013797
A3	180	transparent	000014106

**Predlist za spiralno koričenje Basic**

- transparentni
- debljina: 130 mikrona
- format A4
- pakiranje: 100/1
- šifra: **000026846**



fornax

Podlist za spiralno koričenje

- raznih boja
- debljina 250 g/m²
- pakiranje: 100 listova

Format	Boja	Šifra
A4	bijela	000013798
A4	crna	000013799
A4	crvena	000013800
A4	tamno plava	000013801
A3	tamno plava	000014109
A3	crna	000014108
A3	bijela	000014107

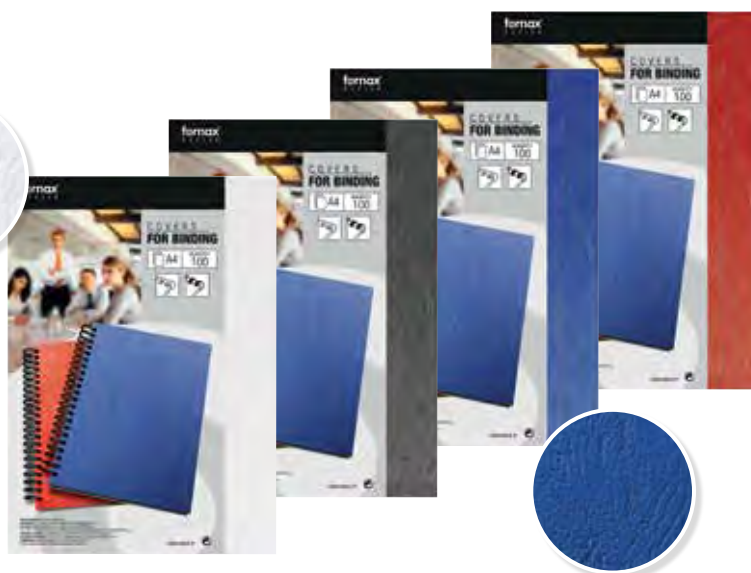

APARATI ZA TVRDO KORIČENJE



Aparat za tvrdo koričenje ImpressBind 280

- idealan za profesionalno koričenje
- omogućuje jako brzo koričenje
- jednostavan za upotrebu
- kapacitet koričenja: 280 listova 80 g/m² papira
- za sve korice od 3,5 mm do 28 mm
- podesiv za format: A4
- pakiranje: 1
- šifra: **000012399**



Debinder

- omogućava razdvajanje korica za tvrdo koričenje za eventualno dodavanje ili izuzimanje uvezanih listova
- za format: A4
- pakiranje: 1
- šifra: **000013738**



KORICE ZA TVRDO KORIČENJE



Korice za tvrdo koričenje

- s transparentnom prednjom koricom
- struktura zadnje korice i hrpta je s tankim linijama
- format: A4
- pakiranje: 10

Širina hrpta (mm)	Kapacitet listova (80g/m ²)		
7	36-70	-	000007301
14	106-140	000011207	-



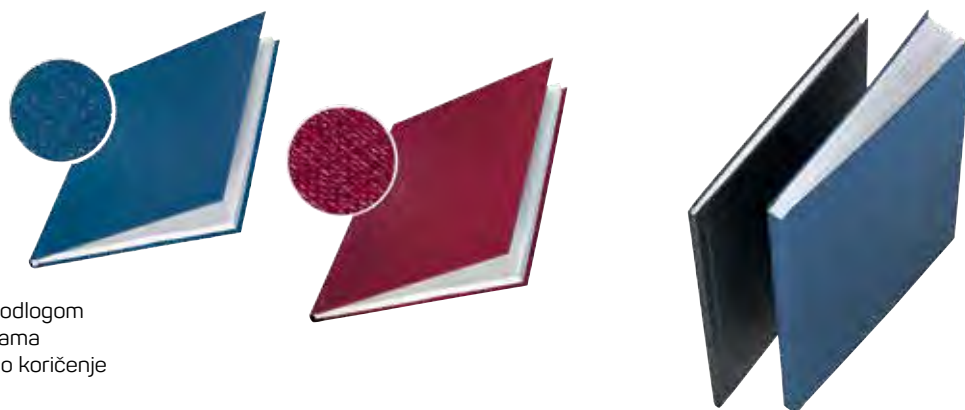

Korice za tvrdo koričenje

- dugotrajne tvrde korice s mat podlogom
- struktura korice je s tankim linijama
- za brzo, savršeno i profesionalno koričenje
- format: A4
- pakiranje: 10

Širina hrpta (mm)	Kapacitet listova (80g/m ²)	White	Black	Blue	Red
3.5	15-35	-	-	000012413	000012912
7	36-70	-	000012914	000012696	000012913
10.5	71-105	-	000002417	000012695	000012694
14	106-140	-	-	000012415	-
17.5	141-175	-	-	000012414	-
21	176-210	-	-	000014161	-
24.5	211-245	-	-	000014016	-

APARATI ZA MEKO-TERMALNO KORIČENJE



Aparat za meko-termalno koričenje T200

- sa zvučnim i vizualnim signalima
- jako brzo koričenje s fiksnim vremenom oko 40 sekundi
- kapacitet koričenja: max. 200 listova 80 g/m² papira koristeći korice od 20 mm
- podesiv za format: A4
- pakiranje: 1
- šifra: **000012137**



Aparat za meko-termalno koričenje T400

- sa zvučnim i vizualnim signalima
- varijabilno vrijeme koričenja
- kapacitet koričenja: max. 400 listova 80 g/m² papira koristeći korice od 40 mm
- podesiv za format: A4
- pakiranje: 1
- šifra: **000014696**



Aparat za meko-termalno koričenje Helios 30

- vrijeme uvezivanja 4 minute
- kapacitet koričenja: max. 300 listova 80 g/m² papira koristeći korice od 30 mm
- zaštita od kontakta s grijačom pločom
- integrirana ladica za hlađenje dokumenta
- podesiv za format: A4
- pakiranje: 1
- šifra: **000024812**



LED interaktivno sučelje jednostavno za koričenje



Selektor debljine korica



Korice za meko-termalno koričenje

- s transparentnom prednjom koricom od 150 mikrona
- različite gramature zadnje korice
- format: A4

Širina hrpta (mm)	Kapacitet listova (80g/m ²)	Zadnja korica (g/m ²)	Pakiranje	White	Black	Blue	Red
1.5	15	250	100/1	000007603	000007859	000007861	-
3	30	250	100/1	000007604	000007862	000007864	000007863
4	40	220	100/1	000007605	-	000012440	-
6	50	250	100/1	000007615	000007865	000007867	-
9	70	220	100/1	000007857	-	-	-
12	110	220	100/1	000007858	-	-	-
15	140	220	50/1	000011518	-	-	-
18	160	220	50/1	000011519	-	-	-
25	240	240	50/1	000011408	-	-	-
30	280	240	50/1	000011409	-	-	-
35	320	240	50/1	000011410	-	-	-
40	370	240	50/1	000011411	-	-	-
50	440	240	50/1	000011413	-	-	-

AKREDITACIJE



Etui za akreditaciju

- sa svilenom vrpcom u crnoj boji
- izrez da možete izvaditi karticu
- veličina kartice: 85x50mm
- duljina trake: 51cm
- vezica crne i plave
- pakiranje: 50

- 000025246
- 000026426

Etui za akreditaciju

- s metalnom kopčom
- dimenzija: 90x55 mm
- pakiranje: 50
- šifra: 000012807

Etui za akreditaciju

- s metalnom kopčom
- dimenzija: 90x58 mm
- pakiranje: 50
- šifra: 000016338

Okovratnik za akreditaciju

- dostupan u raznim bojama
- s metalnom kopčom
- širina 15 mm
- pakiranje: 50

- 000013020
- 000013024
- 000013021
- 000013022
- 000013023
- 000013359
- 000024903

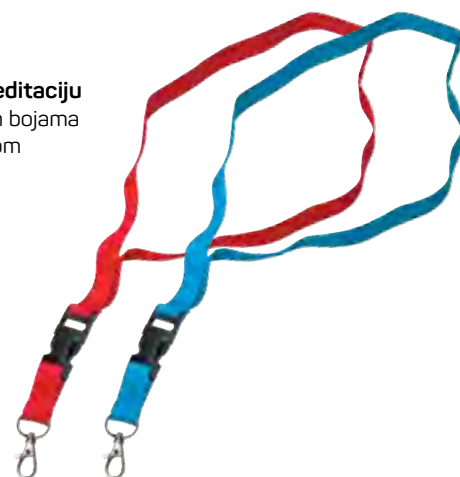

Etui za akreditaciju

- s metalnom kopčom
- dimenzija: 95x75 mm
- pakiranje: 50
- šifra: 000020777



Etui za akreditaciju

- s metalnom kopčom
- dimenzija: 90x60 mm
- pakiranje: 50
- šifra: 000012806

REX

SADOCHE
PRODOTTI CARTOTECHICI

ZA SVAKI POKLON



funkcionalnost, kvaliteta, moderan dizajn -
za pakiranje sa stilom





Artikli za ured i kućanstvo

**Karte za igru**

- 55 karata
- kartonske plastificirane
- boje: crvena i plava
- pakiranje: 1
- šifra: **000033909**

**Karte za igru Canasta**

- 56 karata
- kartonske
- pakiranje: 12
- šifra: **000033222**

**Karte za igru**

- dupli špil karata
- 2 x 55 karata
- kartonske plastificirane
- boje: crvena i plava
- pakiranje: 1
- šifra: **000033908**

ČAŠE I VREĆICE

Čaša PVC

- za sve prilike
- bijele boje
- zapremina: 0,2 l
- pakiranje: 100
- šifra: **000007885**

**Vrećica papirna**

- smeđe boje
- pakiranje: 100/1



Šifra	Dimenzija (cm)
000024433	28+15x38
000024434	32+18x46

**weltplast.****Vrećica PVC**

- žute boje
- dimenzija: 28+(2x7)x55 cm
- pakiranje: 1000/1
- šifra: **000019250**

**weltplast.****Vrećica PVC**

- bijele boje
- dimenzija: 28+(2x8)x55 cm
- pakiranje: 1000/1
- šifra: **000029424**

**weltplast.****Vrećica PVC za otpatke Gea**

- u crnoj, sivoj i plavoj boji
- razne zapremnine
- otporne na kidanje

**weltplast.****Vrećica PVC**

- višenamjenska transparentna vrećica s kliznim zatvaračem
- zapremina: 3 l
- dimenzija: 225x280 mm
- pakiranje: 10/1
- šifra: **000023727**

Šifra	Boja	Opis	Dimenzija (cm)	Zapremina (l)	Pakiranje
000019178	■	-	52x65	40	20/1
000019238	■	s vezicom	54x58	40	12/1
000019131	■	-	70x100	120	10/1
000019355	■	-	70x110	120	10/1
000019290	■	-	80x110	140	10/1

STOLNJACI PAPIRNI

**Stolnjak papirni**

- jednokratni
- bijele boje
- dimenzija: 1.2x7 m
- pakiranje: 25
- šifra: **000028018**

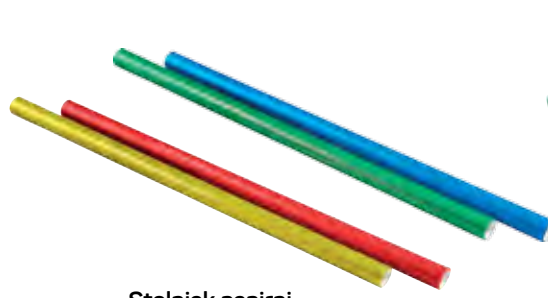
**Stolnjak papirni**

- jednokratni
- sort boje
- dimenzija: 1.2x7 m
- pakiranje: 25
- šifra: **000028019**



HIGIJSKI ARTIKLI

Violeta**Salvete**

- jednoslojne
- dimenzija: 33x33 cm
- bijele boje
- pakiranje: 100/1
- šifra: **000010588**

**Violeta****Maramice papirne**

- troslojne
- 100 % celuloza
- pakiranje: 10/1
- šifra: **000007289**

**Violeta****Ubrusi**

- supersoft ubrusi
- 100% celuloza
- superupijajući
- za svakodnevnu upotrebu
- pakiranje: 2/1
- šifra: **000007287**

**Violeta****Ubrusi**

- supersoft ubrusi
- 100 % celuloza
- superupijajući
- za svakodnevnu upotrebu
- pakiranje: 4/1
- šifra: **000016912**

**Violeta****Ubrusi Jumbo**

- supersoft ubrusi
- 100% celuloza
- superupijajući
- za svakodnevnu upotrebu i čišćenje većih površina
- pakiranje: 1/1
- šifra: **000014110**

**Violeta****Papir toaletni**

- dvoslojni
- 100% celuloza
- s mirisom baby pudera
- pakiranje: 8/1
- šifra: **000006144**





Violeta

Papir toaletni

- troslojni
- 100% celuloza
- s mirisom kamilice
- pakiranje: 10/1
- šifra: **000020755**



Violeta

Papir toaletni

- obiteljsko pakiranje
- dvoslojni
- 100% celuloza
- supersoft s mirisom
- pakiranje: 24/1
- šifra: **000001708**



UHU

Sakupljač vlage

- sakupljač vlage smanjuje vlagu u prostoru te tako sprječava pojavu neugodnih mirisa ustajalog zraka, pojavu plijesni i korozije, kondenzaciju vlage itd.
- najbolje rezultate pokazuje u zatvorenim prostorima bez stalnog dotoka zraka

Šifra	Težina refila (g)	Za prostor od	Pakiranje
000026118	450	35 m ³	6
000026119	1000	80 m ³	6



UHU

Refil za sakupljač vlage

- Refil za ponovno punjenje sakupljača vlage je sastavljeno od posebnih soli, koje na sebe vežu višak vlage u prostoru

Šifra	Težina refila (g)	Za prostor od	Pakiranje
000026120	450	35 m ³	12
000026121	1000	80 m ³	12

Gumice

- raznih veličina
- za svakodnevnu upotrebu
- upotrebljavaju se u kućanstvu, kao i u uredu
- žute boje
- pakiranje: 1 kg



Šifra	Dimenzija (mm)
000000940	Ø15
000020106	Ø20
000018323	Ø30
000018324	Ø40
000018325	Ø50
000018326	Ø60
000018327	Ø70
000018328	Ø80
000018330	Ø100
000018332	Ø120



siam.

Gumice

- raznih veličina u bojama
- u PVC kutiji
- za svakodnevnu upotrebu
- pakiranje: 100 g
- šifra: **000001163**



Gumice

- za svakodnevnu upotrebu
- upotrebljavaju se u kućanstvu, kao i u uredu
- raznih veličina u bojama
- pakiranje: 100 g
- šifra: **000001442**

ŠPIODE

Špiode

- srebrne boje
- u PVC kutiji
- pakiranje: 25 g
- šifra: **000010973**



fornax

- niklovene
- pakiranje: 50 g



Šifra	Veličina	Pakiranje
000021432	26 mm	blister
000021433	27 mm	kutija

lebez

Špiode

- u raznim bojama
- u PVC kutiji
- pakiranje: 100/1



Šifra	Boja
000020636	
000020635	
000020634	
000020633	
000020632	
000027930	
000001154	sort boje



fornax

Špiode

- niklovene
- sort boje
- veličina 28 mm
- blister pakiranje
- pakiranje: 50 g
- šifra: **000021434**



RAJSNIGLE



NIKO

Rajsnigle Niko Železniki

- metalne
- pakiranje: 100/1
- šifra: **000006623**



MOLHO LEONE

Rajsnigle

- metalne
- pakiranje: 100/1
- šifra: **000001082**



CIAC

Rajsnigle

- metalne
- u raznim bojama
- pakiranje: 70/1
- šifra: **0000003342**

PREKRIVNE ZAŠTITNE FOLIJE

tesa

Prekrivna zaštitna folija

- za zaštitu velikih površina od boje, prljavštine, prskanja tekućina kao i radova u vrtu
- otporna na kidanje i laka otapala
- izdržljivi film od PE
- praktične perforacije na svakih 1m duljine
- dimenzija: 4x5 m
- pakiranje: 20
- šifra: **080000001**



tesa

Prekrivna zaštitna folija Extra Strong

- za zaštitu velikih površina od boje, prljavštine, prskanja tekućina kao i radova u vrtu
- otporna na kidanje i laka otapala
- vrlo jaka, izdržljivi film od PE
- praktične perforacije na svakih 1m duljine
- dimenzija: 4 x 5 m
- pakiranje: 10
- šifra: **000022473**



**Prekrivna zaštitna folija s ljepljivom trakom**

- štiti od prskanja boje
- omogućuje precizne i uredne rubove pri bojanju
- dostupna u dvije dimenzije
- pakiranje: 6

Šifra	Dimenzija (m)
000030323	25x0,55
000030324	25x1,4

**Prekrivna zaštitna folija s ljepljivom trakom**

- štiti od prskanja boje
- omogućuje precizne i uredne rubove pri bojanju
- s praktičnim dispenzerom i ugrađenim nožem
- lako se siječe na željenu duljinu
- dimenzija: 33x0,55 m
- pakiranje: 6
- šifra: **000022475**

**Prekrivna zaštitna folija Professional**

- za zaštitu velikih unutrašnjih površina
- za glatke i blago teksturirane površine
- dostupna u dvije dimenzije
- ukupna debljina: 140 mikrona
- pakiranje: 10

Šifra	Dimenzija (m)
000016022	17x2,6
000016021	33x0,55



PAPIR KRAFT ZAŠTITNI

**Papir kraft zaštitni**

- samoljpljivi papir, 50g/m²
- smeđe boje
- brza i jednostavna montaža
- pogodno za aplikaciju za osjetljive površine
- idealan za zaštitu prilikom poslova renoviranja i transporta

Šifra	Dimenzija (cm x m)	Pakiranje
000033078	15x50	12
000033077	30x50	20



**Brtvilo pjenasto**

- samoljepljiva brtva od pjene za prozore i vrata
- štiti od mraza, propuha i buke
- brtvi sve utore od 1 do 5 mm
- meka i elastična
- brzo uklonjiva
- dostupna u bijeloj boji
- dužina: 10 m
- širina: 15 mm
- pakiranje: 20
- šifra: **080000025**

**Brtvilo pjenasto**

- samoljepljiva brtva od pjene za prozore i vrata
- štiti od hladnoće, propuha i buke
- brtvi sve utore od 1 do 5 mm
- meka i elastična
- brzo uklonjiva
- dostupna u bijeloj boji
- dužina: 10 m
- širina: 9 mm
- pakiranje: 32
- šifra: **000022935**

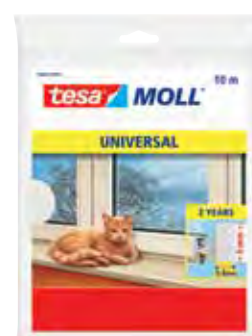
**Brtvilo gumeno D - profil**

- samoljepljiva gumena brtvena traka za prozore i vrata
- štiti od mraza, propuha, prašine i buke
- brtvi sve utore od 3 do 7 mm
- otporna na vremenske utjecaje i UV zrake
- zbog D - profila primjerena za široke utore
- jednostavna za čišćenje
- može izdržati temperature od -50 do +80°C

Šifra	Dimenzija	Boja	Pakiranje
000030326	6 m x 9 mm		10
080000029	6 m x 9 mm		10
000022443	100 m x 9 mm		1 rola
000022445	100 m x 9 mm		1 rola

**Brtvilo gumeno E - profil**

- samoljepljiva gumena brtvena traka za prozore i vrata
- štiti od mraza, propuha, prašine i buke
- brtvi sve utore od 1 do 3,5 mm
- otporna na vremenske utjecaje i UV zrake
- jednostavna za čišćenje

Šifra	Dimenzija	Boja	Pakiranje
080000030	6 m x 9 mm		10
080000031	6 m x 9 mm		10
080000034	100 m x 9 mm		1 rola
080000035	100 m x 9 mm		1 rola

**Brtvilo gumeno P - profil**

- samoljepljiva gumena brtvena traka za prozore i vrata
- štiti od mraza, propuha, prašine i buke
- brtvi sve utore od 2 do 5 mm
- otporna na vremenske utjecaje i UV zrake
- zbog P - profila primjerena za široke utore
- jednostavna za čišćenje

Šifra	Dimenzija	Boja	Pakiranje
080000032	6 m x 9 mm		10
080000033	6 m x 9 mm		10
000022441	100 m x 9 mm		1 rola
000022442	100 m x 9 mm		1 rola



**Mreža protiv insekata**

- za prozore i vrata
- jednostavno namještanje sa samoljepljivom čičak trakom
- reže se po mjeri
- može se prati na temperaturi do 30°C
- oporna na UV zrake
- dostupna u bijeloj i antracit boji
- dimenzija: 1,10x1,30 m
- pakiranje: 7

- 080000037
- 080000038

**Mreža protiv insekata**

- za prozore i vrata
- jednostavno namještanje sa samoljepljivom čičak trakom
- reže se po mjeri
- može se prati na temperaturi do 30°C
- oporna na UV zrake
- dostupna u bijeloj i antracit boji
- dimenzija: 1,30x1,50 m
- pakiranje: 7

- 000020404
- 000020403

**Mreža protiv insekata**

- za vrata
- jednostavno namještanje
- sa samoljepljivom čičak trakom
- reže se po mjeri
- može se prati na temperaturi do 30°C
- oporna na UV zrake
- dostupna u bijeloj i antracit boji
- dimenzija: 2x0,65x2,20m
- pakiranje: 15

- 000022464
- 000022465

**Zamjenska čičak traka**

- za prozore i vrata
- jednostavno namještanje
- za svaki aluminijski, plastični ili drveni okvir
- samoljepljiva je i odstranjuje se bez tragova
- dužina: 5,60 m
- pakiranje: 1
- šifra: 080000036

**Filc podložak**

- za zaštitu osjetljivih ploha ili olakšavanje pomicanja predmeta preko glatkih ploha
- štiti drvo, staklo, parket, laminat i pločice
- pakiranje: 20

Šifra	Ø (mm)	Boja	Sadržaj
080000040	22		12
080000039	22		12
080000041	26		9
080000080	26		9





Četka za vrata

- štiti od prljavštine, prašine i hladnoće
- za neravne podove
- za do 15 mm široke utore
- materijal: plastika
- trajnost 8 godina
- samoljepljiva; jednostavno namještanje bez vijaka i čavala
- u bijeloj i smeđoj boji
- dimenzija: 1 m x 40 mm
- pakiranje: 5

- 000022436
- 000022435



Četka za vrata

- štiti od prljavštine, prašine i hladnoće
- za duboke tepihe
- za do 15 mm široke utore
- materijal: plastika
- trajnost 6 godina
- samoljepljiva; jednostavno namještanje bez vijaka i čavala
- u bijeloj i smeđoj boji
- dimenzija: 1 m x 43 mm
- pakiranje: 5

- 000022438
- 000022437

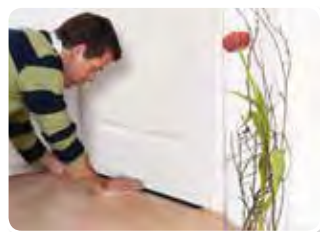

Četka za vrata

- štiti od prljavštine, prašine i hladnoće
- za glatke podove, kao što su parket, laminat ili PVC
- za do 12 mm široke utore
- materijal: plastika
- trajnost 4 godine
- samoljepljiva; jednostavno namještanje bez vijaka i čavala
- u bijeloj, smeđoj i prozirnoj boji
- dimenzija: 1 m x 37 mm
- pakiranje: 5

- 080000070
- 080000068
- 080000069



VJEŠALICE SAMOLJEPLJIVE



Vješalica samoljepljiva okrugla S

- izrađena od visokokvalitetne plastike
- lako se lijepi na staklu, drvetu, pločicama i dr. podlogama
- mogućnost odljepljivanja bez traga i upotrebe više puta
- može držati predmete do max. 1 kg
- sadrži 3 vješalice
- dostupna u plavoj boji
- pakiranje: 6
- šifra: 000022415



**Vješalica samoljepljiva ovalna XS metal**

- jednostavna montaža bez bušenja i vijaka
- lako se lijepi na staklu, drvetu, pločicama, staklu, plastici i dr. glatkim površinama
- brušeni nehrđajući čelik
- sadrži 4 vješalice
- dimenzija vješalice: 17x28x14 mm
- pakiranje: 12
- šifra: **000030331**

**Vješalica samoljepljiva ovalna XS**

- jednostavna montaža bez bušenja i vijaka
- lako se lijepi na staklu, drvetu, pločicama, staklu, plastici i dr. glatkim površinama
- kvalitetna kromirana plastika
- sadrži 6 vješalica
- pakiranje: 12
- šifra: **000030328**

**Vješalica samoljepljiva ovalna S**

- jednostavna montaža bez bušenja i vijaka
- lako se lijepi na staklu, drvetu, pločicama, staklu, plastici i dr. glatkim površinama
- kvalitetna kromirana plastika
- sadrži 2 vješalice
- dimenzija vješalice: 26x43x20 mm
- pakiranje: 12
- šifra: **000030329**

**Vješalica samoljepljiva ovalna S**

- napravljena od iznimno kvalitetnog umjetnog materijala
- lako se lijepi na staklu, drvetu, pločicama i dr. podlogama
- mogućnost odljepljivanja bez traga i upotrebe više puta
- može držati predmete do max. 1 kg
- sadrži 3 vješalice
- dostupne boje: krom i plava
- pakiranje: 6

■ • **000022934**

■ • **000022407**

**Vješalica samoljepljiva ovalna L**

- napravljena od iznimno kvalitetnog umjetnog materijala
- lako se lijepi na staklu, drvetu, pločicama i dr. podlogama
- mogućnost odljepljivanja bez traga i upotrebe više puta
- može držati predmete do max. 2 kg
- sadrži 2 vješalice
- pakiranje: 6

■ • **080000050**

■ • **080000078**

■ • **000022426**





Vješalica samoljepljiva ovalna L

- jednostavna montaža bez bušenja i vijaka
- lako se lijepi na staklu, drvetu, pločicama, staklu, plastici i dr. glatkim površinama
- kvalitetna kromirana plastika
- sadrži 2 vješalice
- dimenzija vješalice: 34x55x28 mm
- pakiranje: 12
- šifra: **000030330**



Vješalica samoljepljiva četvrtasta S

- izrađena od visokokvalitetne plastike
- lako se lijepi na staklu, drvetu, pločicama i dr. podlogama
- mogućnost odljepljivanja bez traga i upotrebe više puta
- može držati predmete do max. 1 kg
- sadrži 3 vješalice
- dostupne boje: žuta i zelena
- pakiranje: 6

• 000022526

• 000022527



Vješalica samoljepljiva četvrtasta S

- izrađena od visokokvalitetne plastike
- lako se lijepi na staklu, drvetu, pločicama i dr. podlogama
- mogućnost odljepljivanja bez traga i upotrebe više puta
- može držati predmete do max. 1 kg
- sadrži 3 vješalice
- dostupna u mat krom boji
- pakiranje: 6
- šifra: **000022404**



Vješalica samoljepljiva četvrtasta S

- napravljena od iznimno kvalitetnog umjetnog materijala
- lako se lijepi na staklu, drvetu, pločicama i dr. podlogama
- mogućnost odljepljivanja bez traga i upotrebe više puta
- može držati predmete do max. 1 kg
- sadrži 3 vješalice
- dostupne boje: bijela, krom i plava
- pakiranje: 6

• 080000046

• 080000048

• 000022400



**Vješalica samoljepljiva četvrtasta L**

- jednostavna montaža bez bušenja i vijaka
- lako se lijepi na staklu, drvetu, pločicama, staklu, plastici i dr. glatkim površinama
- kvalitetna kromirana plastika
- sadrži 2 vješalice
- dimenzija vješalice: 29x36x19 mm
- pakiranje: 12
- šifra: **000030332**

**Vješalica samoljepljiva četvrtasta L**

- napravljena od iznimno kvalitetnog umjetnog materijala
- lako se lijepi na staklu, drvetu, pločicama i dr. podlogama
- mogućnost odljepljivanja bez traga i upotrebe više puta
- može držati predmete do max. 2 kg
- sadrži 2 vješalice
- dostupna u bijeloj boji
- pakiranje: 6
- šifra: **080000049**

**Vješalica samoljepljiva sa kukicama**

- izrađena od visokokvalitetne plastike
- lako se lijepi na staklu, drvetu, pločicama i dr. podlogama
- mogućnost odljepljivanja bez traga i upotrebe više puta
- može držati predmete do max. 3 kg
- sadrži 1 vješalicu
- dostupne boje: mat krom i bijela
- pakiranje: 6

• **000022429**

• **000022867**

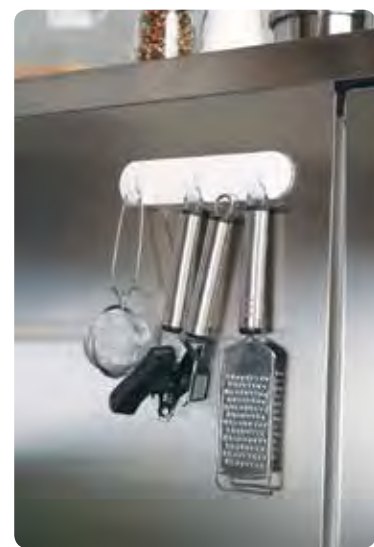
**Vješalica samoljepljiva stropna**

- izrađena od visokokvalitetne plastike
- zakretna glava kuke omogućuje precizno držanje objekata
- može držati predmete do max. 500 g
- dostupna u bijeloj boji
- pakiranje: 10
- šifra: **000022933**





**tesa[®] BASIC
LJEPILO
U STICKU**



**Ljepljiva krep traka Professional**

- za sve vanjske radove bojanja
- otporna na UV zrake i vlagu do 2 tjedana
- otporna na kidanje i laka za rastezanje
- ukupna debljina: 145 mikrona
- dimenzija: 50 m x 30 mm
- pakiranje: 5
- šifra: **000023370**

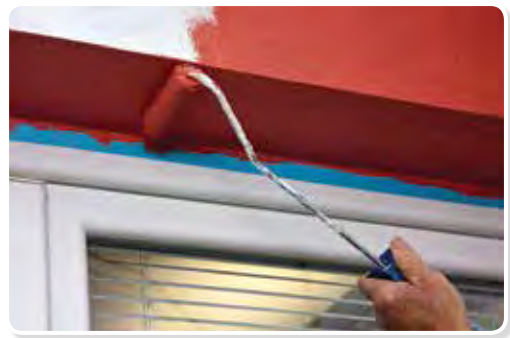
**Ljepljiva krep traka**

- za korištenje unutra i vani
- omogućava precizne, jasne rubove na glatkim i blago hrapavim površinama, bez razlijevanja boje
- odstranjuje se bez tragova do 7 dana unutra, a do 3 dana vani
- za sve vrste emulzijskih boja

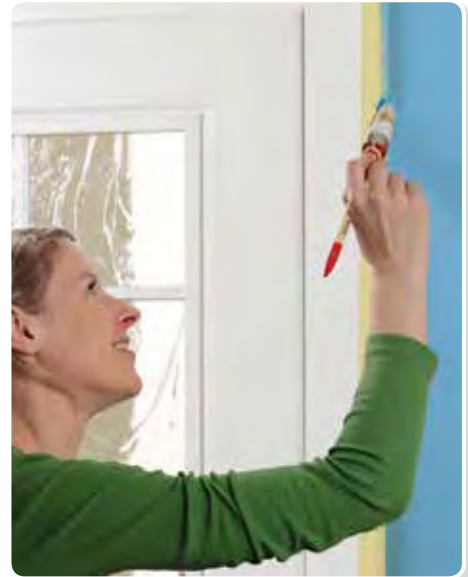

Šifra	Dimenzija (m x mm)	Pakiranje
000022872	50x19	16
000022873	50x25	12
000022874	50x30	10
000022875	50x38	8
000022876	50x50	6

**Ljepljiva traka za žbukanje**

- za zaštitu osjetljivih i glatkih površina od prljanja i oštećenja prilikom žbukanja i bojanja
- pogodna za rad na temp. većim od 5°C
- odstranjuje se bez tragova i nakon 6 tjedana primjene vani
- lako se kida rukom

Šifra	Dimenzija (m x mm)	Pakiranje
000022487	33x30	6
000022486	33x50	6

**Ljepljiva traka za prekrivanje pukotina**

- prekriva pukotine i spojeve
- minimalno uzdizanje
- boja i tapete se mogu nanositi odmah nakon primjene
- trajno sprječava pucanje tapeta
- dimenzija: 10 m x 50 mm
- pakiranje: 6
- šifra: **000022483**





tesa

Obostrana ljepljiva traka montažna

- snažna traka za sigurno i brzo pričvršćivanje
- idealna za staklo i prozirne predmete
- potpuno prozirna i izuzetno tanka
- drži i do 2 kg s pomoću 10 cm trake
- lijepi se na staklo, pločice, gips, drvo i većinu plastičnih materijala

Šifra	Dimenzija (m x mm)	Pakiranje
080000061	1,5x19	12
000022968	5x19	10



tesa

Obostrana ljepljiva traka montažna Powerbond

- idealna za unutarnju i vanjsku upotrebu
- ultra jako držanje
- drži do 10 kg na 10cm trake
- nije otporna na UV zračenje i vodu



Šifra	Dimenzija (m x mm)	Pakiranje
000022901	1,5x19	12
000022902	5x19	10



tesa

Obostrana ljepljiva traka montažna

- za ogledala
- snažna obostrano ljepljiva traka za sigurno i brzo pričvršćenje ogledala i drugih ravnih predmeta u vlažnim prostorijama
- otporna na vlagu
- dimenzija: 1,5 m x 19 mm
- pakiranje: 12
- šifra: **000022899**

tesa

Obostrana ljepljiva traka montažna Powerbond

- idealna za vanjsku upotrebu
- drži do 1kg na 10cm trake
- otporna na UV zračenje, vodu i promjene temperature
- dimenzija: 1,5 m x 19 mm
- pakiranje: 12
- šifra: **000022481**



tesa

Obostrana ljepljiva traka montažna Professional

- za pričvršćivanje ogledala i dekorativnih materijala
- visoko kvalitetna pjenasta podloga
- izvanredna snaga prijanjanja na glatke i hrapave površine
- otporna na starenje i vlagu
- ukupna debljina: 1150 mikrona
- dimenzija: 10 m x 19 mm
- pakiranje: 16
- šifra: **000016047**

tesa

Obostrana ljepljiva traka montažna

- izuzetno snažno držanje
- za pričvršćivanje manjih predmeta u zatvorenom prostoru
- drži i do 4,2 kg s pomoću 10 cm trake
- lijepi se na pločice, gips, drvo i većinu plastičnih materijala
- dimenzija: 5 m x 38 mm
- pakiranje: 5
- šifra: **000022480**



Obostrana ljepljiva traka montažna Professional

- za pričvršćivanje lakših predmeta
- visoko prilagodljiva pjenasta podloga
- prijanjanja na glatke i blago hrapave površine
- ukupna debljina: 1050 mikrona
- dimenzija: 10 m x 19 mm
- pakiranje: 16
- šifra: **000016048**



Obostrana ljepljiva traka Professional

- prikladna za montažu lakih predmeta
- za glatke površine
- veoma tanka podloga
- ukupna debljina: 115 mikrona
- dimenzija: 50 m x 50 mm
- pakiranje: 6
- šifra: **000026311**



Obostrana ljepljiva traka

- višenamjenska dvostrana ljepljiva traka za polaganje podnih obloga i za trajno ljepljenje raznih materijala
- s lakoćom se trga rukom
- pakiranje: 6



Šifra	Dimenzija (m x mm)
000001993	10x50
000012505	50x12
000006789	50x19
000006788	50x25
000007336	50x50



Obostrana ljepljiva traka univerzalna

- transparentna ljepljiva traka
- idealna za postavljanje tepiha
- trajno pričvršćenje različitih materijala
- kida se rukom
- kvalitetna folija
- pakiranje: 6

Šifra	Dimenzija (m x mm)
080000012	5x50
080000014	25x50



Obostrana ljepljiva traka za podne obloge

- za pričvršćivanje svih vrsta tepiha i PVC materijala
- prijanja za mnoge vrste podova i skida se bez tragova
- ojačana tekstilom
- nije pogodna za podove od prirodnog kamena
- lako se kida rukom
- pakiranje: 6

Šifra	Dimenzija (m x mm)
000022959	5x50
000022960	10x50



Obostrana ljepljiva traka za podne obloge

- extra jako držanje
- za pričvršćivanje svih vrsta tepiha i PVC materijala
- prijanja za mnoge vrste podova
- može se koristiti i uz podno grijanje
- lako se kida rukom
- pakiranje: 6

Šifra	Dimenzija (m x mm)
000022975	10x50
000022976	25x50



**Izolacijska traka**

- za izolaciju i popravke na električnim vodovima
- mehanički štiti kableske ovojnice od oštećenja
- teško zapaljiva
- jednostavno namatanje i oko neravnih predmeta
- pouzdano štiti od proboja napona do 6000 V

Šifra	Dimenzija (m x mm)	Boja	Pakiranje
080000021	10x15		10
080000023	10x15		10
080000022	10x15		10
080000020	10x15		10
080000024	10x15		10
080000017	20x19		8
080000019	20x19		8
080000018	20x19		8
080000016	20x19		8
080000075	20x19		8



TRAKE ZA POPRAVKE

**Aluminijska traka Professional**

- pogodna za zaštitu, pokrivanje, izoliranje i popravke
- velika snaga prijanjanja
- otporna na temperaturu od -40°C do +140°C
- otporna na vodu, ulje, masnoću i starenje
- pakiranje: 6

Šifra	Dimenzija (m x mm)
080000008	10x48
000016040	50x50

**Traka armirana Gaffer Professional**

- snažno ljepljenje čak i na hrapavim površinama
- pogodna za označavanje, pakiranje, zaštitu, pričvršćivanje, spajanje kablova i žica
- dimenzija: 50 m x 25 mm
- pakiranje: 5

- 000016037
- 000016036

**Traka ljepljiva Fiberglass**

- idealna za lake i teške popravke, renoviranje i održavanje
- za profesionalna rješenja, kao što su ručni radovi, pričvršćivanje, povezivanje, ojačanje itd.
- za spojeve gipsanih ploča
- jako ljepilo i velika izdrživost garantiraju vrhunske rezultate
- debljina: 203 µm
- pakiranje: 6

Šifra	Dimenzija (m x mm)
000022964	25x48
000016020	45x48
000022965	90x48

**Traka armirana Duct Professional**

- snažno ljepljenje čak i na hrapavim površinama
- vodoodbijajuća
- pogodna za označavanje, pakiranje, zaštitu, pričvršćivanje, spajanje kablova i žica
- dimenzija: 50 m x 48 mm
- pakiranje: 1

- 000016039
- 000016038





Ljepljiva traka Extra Power Universal

- višenamjenska traka za popravke u kućanstvu i poslu
- od polietilenske folije i posebno jakog platna za velika opterećenja
- otporna na vremenske utjecaje
- lako se trga rukom
- u raznim bojama
- pakiranje: 6

Šifra	Dimenzija (m x mm)	Boja
08000004	25x50	<input type="checkbox"/>
08000003	25x50	<input checked="" type="checkbox"/>
08000006	50x50	<input checked="" type="checkbox"/>
08000005	50x50	<input type="checkbox"/>
08000002	25x50	<input type="checkbox"/>



Prozirna ljepljiva traka Extra Power

- iznimno ljepljiva na hrapavim i na glatkim površinama
- služi za spajanje i lijepljenje polietilenske folije
- otporna na temperature od -28°C do +65°C
- postojana u vodi
- otporna na UV zrake do 6 mjeseci
- pakiranje: 6

Šifra	Dimenzija (m x mm)	Boja
08000007	20x48	<input type="checkbox"/> transp.
000022962	10x50	<input type="checkbox"/>
080000053	10x50	<input type="checkbox"/>
080000076	10x50	<input checked="" type="checkbox"/>



Protuklizna traka

- idealna za stepenice, rampe, ljestve, te glatke skilske podove
- presvučena je vrlo hrapavom i izdržljivom oblogom koja ne klizi
- čvrsto se zalijepi
- otporna na toplinu i vodu
- pakiranje: 6

Šifra	Dimenzija (m x mm)	Boja
080000071	5x25	<input type="checkbox"/>
080000072	5x25	<input checked="" type="checkbox"/>
000022280	5x25	<input type="checkbox"/>
000022963	15x25	<input checked="" type="checkbox"/>
000022477	5x50	<input checked="" type="checkbox"/>

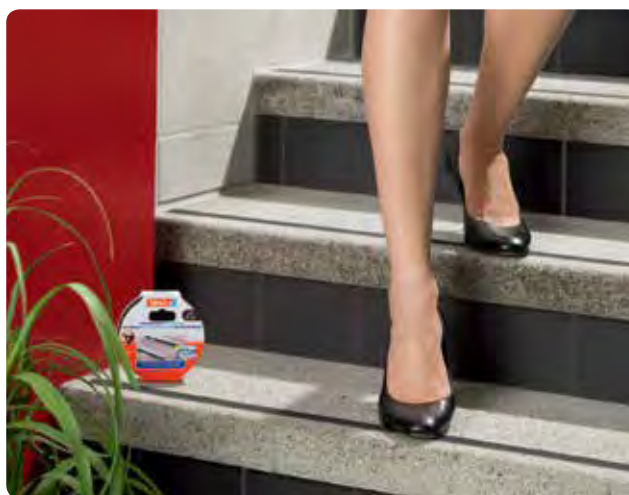

TRAKE AUTOMOTIV



Traka automotiv

- namjenjena je za spajanje kablova u snopove u automobilima
- štiti kablove od oštećivanja
- toplinska otpornost od -40°C do +105°C/3000h
- debljina: 250 µm
- dimenzija: 19 mm x 25 m
- pakiranje: 16
- šifra: **000025055**



Traka automotiv

- namjenjena je za spajanje kablova u snopove u automobilima
- štiti kablove od oštećivanja
- kida se rukom
- toplinska otpornost od -40°C do +125°C/3000h
- debljina: 150 µm
- dimenzija: 19 mm x 25 m
- pakiranje: 16
- šifra: **000025054**



ROLA MAGNETNA

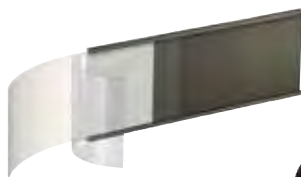

Rola magnetna za etikete

- s prozirnolom folijom i papirom
- može se rezati
- tamno smeđe boje
- dimenzija: 30 mm x 50 m
- pakiranje: 1
- šifra: **000012420**



FOLIJE ZA OMOTAVANJE I DRŽAČ

Folije za omotavanje

- u roli
- 23 mikrona
- transparentna folija
- standardna i strojna
- pakiranje: 1

Šifra	Masa (kg)	Opis
000011037	2.8	standard
000011039	5	standard
000018520	15	strojna



Držač folije za omotavanje

- ručni držač
- željezna konstrukcija držača
- pakiranje: 1
- šifra: **000002447**

MJERNE TRAKE U ROLI



Mjerna traka u roli

- metalna
- na izvlačenje
- dužina metra: 20 m
- pakiranje: 1
- šifra: **000009137**

Mjerna traka u roli

- metalna
- na izvlačenje
- dužina metra: 30 m i 50 m
- pakiranje: 1

Šifra	Opis
000020225	50 m
000012381	30 m





NEW!

Perfect for all ideas

edding quality out of a spray can!



- edding Permanent Spray**
- ☑ covers immediately
 - ☑ extremely quick-drying
 - ☑ long-lasting indoor & outdoor
 - ☑ for almost all surfaces

Available in 30 colors:



www.edding-permanent-spray.com



Boja akrilna u spreju E-5200

- permanentna
- boja akrilnog pigmenta osigurava visoku pokrivenost
- za bojanje: papira, kamena, drva, tapeta, tekstila, metala, stakla, keramike i plastike, pogodno za stiropor (potrebno je prije nanijeti primer)
- standardni raspršivač ima širinu raspršivanja od ca. 5-6 cm
- brzo se suši, potpuno suho za 30 minuta
- velika pokrivenost: 200 ml za otprilike 0,70-1 m² površine
- sort boje
- pakiranje: 1

 • 000033885

 • 000033891

 • 000033880

 • 000033888

 • 000033884

 • 000033887

 • 000033886

 • 000033889

 • 000033890

 • 000033879

Primer u spreju E-5200

- univerzalni (za gotovo sve materijale)
- zaglađuje neravnine
- dugotrajan i lako se nanosi
- za vrhunsko prijanjanje boje i maksimalan sjaj
- štiti od hrđe
- 200 ml spreja je dovoljno za 0,4 m² površine
- pakiranje: 1
- šifra: **000033892**



Primer u spreju E-5200

- za plastiku, brzосуšeći
- zaglađuje neravnine
- kreira zaštitni sloj između tvrde plastike i naknadnog sloja boje
- za vrhunsko prijanjanje boje i maksimalan sjaj
- dugotrajan na vanjskoj i unutarnjim uvjetima
- suho nakon 15 minuta
- 200 ml spreja je dovoljno za 2-3 m² površine
- pakiranje: 1
- šifra: **000033882**



Kapica za boje E-5200N

- za sprej E-5200
- 4 vrste raspršivanja:
2 x bijela kapica - fino raspršivanje (cca. 1 cm),
2 x crna kapica - srednje raspršivanje (cca. 4-5 cm),
1 x zlatna kapica - široko raspršivanje (cca. 8-10 cm) i
1 x crvena kapica - promjenjivo raspršivanje (cca. 13-14 cm)
- set 6/1
- pakiranje: 1
- šifra: **000033883**



**Pištolj za ljepljenje 8052 050**

- električni
- napon: 110-240 V
- snaga: 15-50 W
- koristi okrugle patrone Ø10 mm
- pakiranje uključuje instrukcije za upotrebu i 2 patrone
- dimenzija: 19x17 cm
- pakiranje: 1
- šifra: **000024395**

**Pištolj za ljepljenje 8052 018**

- električni
- napon: 110-240 V
- snaga: 11-30 W
- koristi okrugle patrone Ø7 mm
- pakiranje uključuje instrukcije za upotrebu i 2 patrone
- dimenzija: 12x11 cm
- pakiranje: 1
- šifra: **000024396**

**Patrone**

- za pištolj 8052 050
- patrone Ø10 mm
- dužina: 10 ili 20 cm

Šifra	Dužina (cm)	Pakiranje
000024398	10	6/1
000024399	20	9/1
000024400	20	50/1

**Patrone**

- za pištolj 8052 018
- patrone Ø7 mm
- dužina: 10 cm
- pakiranje: 12/1
- šifra: **000024397**



Špaga kudeljna

• pogodna za domaćinstvo, građevinu...

Šifra	Oznaka	Opis	Težina (g)	Pakiranje
000020714	6/2	3000 m/kg - 2 niti	100	10/1
000000989	4/2	2000 m/kg - 2 niti	100	10/1
000023536	2,5/2	1250 m/kg - 2 niti	200	1/1
000023581	2,5/2	1250 m/kg - 2 niti	100	1/1
000023582	1,25/2	625 m/kg - 2 niti	200	1/1
000004077	2,3/4	575 m/kg - 4 niti	500	6/1
000000988	1/2	500 m/kg - 2 niti	100	10/1
000023583	0,90/2	450 m/kg - 2 niti	500	1/1
000023584	0,60/2	300 m/kg - 2 niti	500	1/1
000023586	0,40/2	200 m/kg - 2 niti	500	1/1
000023585	0,40/3	133 m/kg - 3 niti	500	1/1



NAČIN OZNAČAVANJA ŠPAGE KUDELJNE

- prvi broj označava ukupnu dužinu niti od koje je napravljena špaga u kilometrima
- drugi broj označava broj upletenih niti u špagi
- ukupna dužina špaga se izračunava na osnovu dijeljena ukupne dužine niti s brojem niti



RAFIJA

HEYDA

Rafija

- 50 gr u snopu
- prirodna
- raznih boja
- pakiranje: 1



• 000017929



• 000017919



• 000017920



• 000017924



• 000017921



• 000017922



• 000017918



• 000017916



• 000017917



• 000017923



• 000017925



• 000017926



• 000017927



• 000017928

VRPCE UKRASNE



• 000025331



• 000025328



• 000025330



• 000025334



• 000025329



• 000025333



• 000025337



• 000025335



• 000025338



• 000025332



• 000025336

Vrpca ukrasna

- dimenzija: 10 mm x 250 m
- raznih boja
- pakiranje: 1

PAPIRI UKRASNI



Papir ukrasni Perlage

- sort boje
- reciklirani papir
- dimenzija: 70x200 cm
- pakiranje: 50
- šifra: **000024186**



Papir ukrasni Light Eco

- sort boje
- dimenzija: 70x200 cm
- pakiranje: 50
- šifra: **000024581**



Papir ukrasni Lucido Tuttocolore

- sort boje
- dimenzija: 70x200 cm
- pakiranje: 50
- šifra: **000024189**



**Papir ukrasni Acquerello**

- sort boje
- reciklirani papir
- dimenzija: 70x200 cm
- pakiranje: 50
- šifra: **000032116**

**Papir ukrasni**

- u roli
- dimenzija: 50x500 cm
- pakiranje: 50
- šifra: **000012321**

**Papir ukrasni Christmas**

- sort boje
- reciklirani papir
- dimenzija: 70x200 cm
- pakiranje: 50
- šifra: **000024582**

**Papir ukrasni Pastello**

- sort boje
- dimenzija: 70x200 cm
- pakiranje: 50
- šifra: **000031185**

**Papir ukrasni Raso Tendenze Q**

- sort motivi
- dimenzija: 70x200 cm
- pakiranje: 50
- šifra: **000024187**





SADOCH

Papir ukrasni Fantasia

- sort motivi
- reciklirani papir
- dimenzija: 70x200 cm
- pakiranje: 50
- šifra: **000025221**



SADOCH

Papir ukrasni Graphic

- sort boje
- reciklirani papir
- dimenzija: 70x200 cm
- pakiranje: 50
- šifra: **000024185**



SADOCH

Papir ukrasni Glitter

- sort motivi
- dimenzija: 70x100 cm
- pakiranje: 50
- šifra: **000025222**



SADOCH

Papir ukrasni Disney Big

- sort motivi
- dimenzija: 70x300 cm
- pakiranje: 50
- šifra: **000025223**



SADOCH

Papir ukrasni Marvel

- sort motivi
- dimenzija: 70x200 cm
- pakiranje: 50
- šifra: **000024202**





Papir ukrasni Disney Generico 1

- sort motivi
- dimenzija: 70x200 cm
- pakiranje: 50
- šifra: 000024190



Papir ukrasni Minions

- sort motivi
- dimenzija: 70x200 cm
- pakiranje: 50
- šifra: 000030368



Papir ukrasni Raso

- u roli
- dimenzija: 70x200 cm
- pakiranje: 50
- šifra: 000031380



Papir ukrasni

- u roli
- dimenzija: 70x500 cm
- pakiranje: 50
- šifra: 000012393



PAPIRI UKRASNI



HEYDA

Papir ukrasni u roli

- 32 g/m²
- dimenzija: 70x150 cm
- raznih boja
- pakiranje: 5



KREP PAPIRI

HEYDA

Krep papir u roli

- 60 g/m²
- dimenzija: 50x250 cm
- zlatne i srebrne boje
- metalizirane
- pakiranje: 10

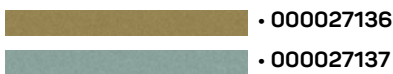

HEYDA

Krep papir u roli

- 32 g/m²
- dimenzija: 50x250 cm
- raznih boja
- pakiranje: 10



Celofan ukrasni

- prozirni
- u roli
- dimenzija: 100x70 cm
- pakiranje: 10/1
- šifra: **000031055**

**Celofan ukrasni**

- prozirni s motivima
- u roli
- dimenzija: 100x70 cm
- pakiranje: 10/1
- šifra: **000031056**

**Celofan ukrasni**

- prozirni
- dimenzija: 100x130 cm
- pakiranje: 25/1
- šifra: **000000222**

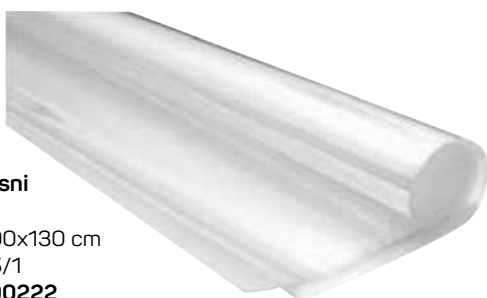
**Celofan ukrasni**

- transparentni
- plave boje
- dimenzija: 100x130 cm
- pakiranje: 50/1
- šifra: **000001504**

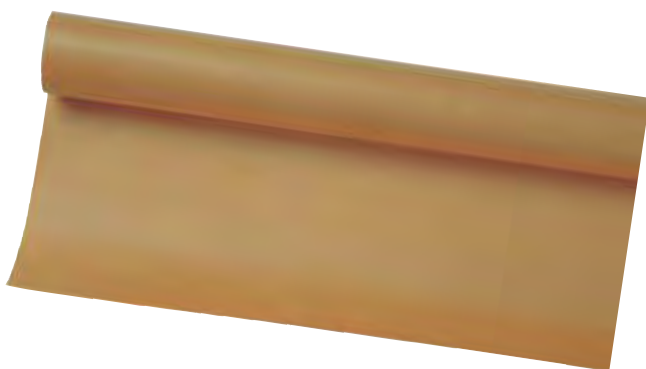

NATRON PAPIR OMOTNI

**Papir omotni**

- natron, u roli
- 90 g/m²
- dimenzija: 10m x 1m
- pakiranje: 20
- šifra: **000019113**



HEYDA

Traka ljepljiva Deco 2/1

- za dekoriranje
- 4 motiva, sortirano
- 2 dimenzije: 15mm x 5m, 45mm x 5m
- pakiranje: 20
- šifra: **000030562**



HEYDA

Traka ljepljiva Colour Code 4/1

- za dekoriranje
- 4 motiva crvene boje
- dimenzija: 15 mm x 5 m
- pakiranje: 5
- šifra: **000028665**



HEYDA

Traka ljepljiva Colour Code 4/1

- za dekoriranje
- 4 motiva ljubičaste boje
- dimenzija: 15 mm x 5 m
- pakiranje: 5
- šifra: **000028669**



HEYDA

Traka ljepljiva Colour Code 4/1

- za dekoriranje
- 4 motiva plave boje
- dimenzija: 15 mm x 5 m
- pakiranje: 5
- šifra: **000028667**



HEYDA

Traka ljepljiva Colour Code 4/1

- za dekoriranje
- 4 motiva roze boje
- dimenzija: 15 mm x 5 m
- pakiranje: 5
- šifra: **000028666**



HEYDA

Traka ljepljiva Colour Code 4/1

- za dekoriranje
- 4 motiva sive/crne boje
- dimenzija: 15 mm x 5 m
- pakiranje: 5
- šifra: **000028670**



HEYDA

Traka ljepljiva Colour Code 4/1

- za dekoriranje
- 4 motiva zelene boje
- dimenzija: 15 mm x 5 m
- pakiranje: 5
- šifra: **000028668**



HEYDA

Traka ljepljiva Glitter 3/1

- za dekoriranje
- 3 gliter boje
- dimenzija: 15 mm x 3 m
- pakiranje: 6
- šifra: **000031796**



HEYDA

Traka ljepljiva Metallic 5/1

- sa stalkom
- za dekoriranje
- 5 motiva
- dimenzija: 12 mm x 3 m
- pakiranje: 6
- šifra: **000031797**



HEYDA

Traka ljepljiva Metallic 5/1

- sa stalkom
- za dekoriranje
- 5 motiva
- dimenzija: 12 mm x 3 m
- pakiranje: 6
- šifra: **000031798**

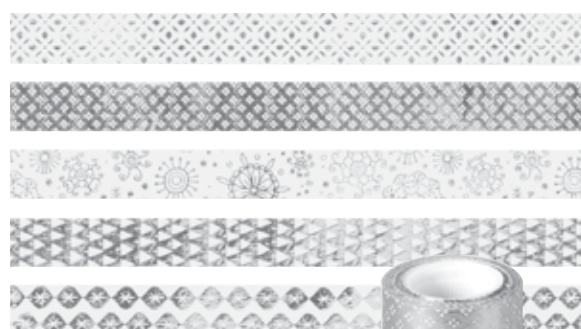



HEYDA

Traka ljepljiva ukrasna Čipka

- ljepljiva traka za dekoriranje poklona, kutija, čestitki, čaša ...
- 11 boja
- dimenzija: 15 mm x 2 m
- display pakiranje: 36
- šifra: **000033596**



HEYDA

Traka ljepljiva ukrasna Spring

- ljepljiva traka za dekoriranje poklona, kutija, čestitki...
- 9 motiva
- dimenzija: 15 mm x 10 m
- display pakiranje: 36
- šifra: **000024997**



HEYDA

Traka ljepljiva ukrasna Deco

- ljepljiva traka za dekoriranje poklona, kutija, čestitki...
- 9 motiva
- dimenzija: 15 mm x 10 m
- display pakiranje: 36
- šifra: **000024996**



**Poklon vrećice Tinta Unita**

- mat plastificirana
- 157 g/m²
- boja: crvena
- pakiranje: 10

Šifra	Dimenzije (mm)
000024207	120x370x90
000024209	220x100x265
000024210	320x100x415

**Poklon vrećice Tinta Unita**

- mat plastificirana
- 157 g/m²
- boja: tamno plava
- pakiranje: 10

Šifra	Dimenzije (mm)
000024211	120x370x90
000024212	220x100x265
000024213	320x100x415

**Poklon vrećice Tinta Unita**

- mat plastificirana
- 157 g/m²
- boja: ljubičasta
- pakiranje: 10

Šifra	Dimenzije (mm)
000024214	220x100x265
000024215	320x100x415

**Poklon vrećice Tinta Unita**

- mat plastificirana
- 157 g/m²
- boja: zelena
- pakiranje: 10

Šifra	Dimenzije (mm)
000024216	220x100x265
000024217	320x100x415



- Poklon vrećice Glitter**
- mat plastificirana s gliterom
 - 157 g/m²
 - boja: crvena
 - pakiranje: 10

Šifra	Dimenzije (mm)
000024586	205x115x260
000024587	300x120x410



- Poklon vrećice Glitter**
- mat plastificirana s gliterom
 - 157 g/m²
 - boja: plava
 - pakiranje: 10

Šifra	Dimenzije (mm)
000024590	205x115x260
000024591	300x120x410



- Poklon vrećice Glitter**
- mat plastificirana s gliterom
 - 157 g/m²
 - boja: bijela
 - pakiranje: 10

Šifra	Dimenzije (mm)
000024588	205x115x260
000024589	300x120x410



- Poklon vrećice**
- mat plastificirana s UV lakom
 - 157 g/m²
 - karo uzorak
 - pakiranje: 10

Šifra	Dimenzije (mm)
000024583	205x115x260
000024584	300x120x410







- Poklon vrećice Glitter**
- mat plastificirana s gliterom
 - s 3D motivom
 - 157 g/m²
 - pakiranje: 10

Šifra	Dimenzije (mm)
000025225	205x115x260
000025224	300x120x410



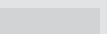

**Poklon vrećice**

- raznih dimenzija
- raznih boja
- pakiranje: 12

					Sort motivi	Dimenzije (mm)	Opis
000011742	-	000011743	000011745	000012924	-	130x360x85	mala (za bocu)
-	000016828	000016829	-	-	000013206	100x180x230	srednja
-	000012921	-	-	-	-	100x330x460	jumbo

**forname****Poklon vrećice**

- sjajna plastifikacija
- jednobojne
- ojačane su pod ručkama i podnicom
- pletene ručke u odgovarajućoj boji
- papir: 157 g/m²
- pakiranje: 10

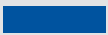
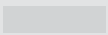
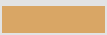
					Dimenzije (mm)
000028176	000028175	000028174	000028178	000028177	130x400x80
000029123	000029122	-	000029124	000029121	180x230x100
000028179	000028180	000028181	000028183	000028182	240x160x70
000028184	000028185	000028186	000028187	000028188	240x390x90
000029127	-	000029126	000029128	000029125	260x320x130
000029130	-	000029129	000029132	000029131	330x460x100
000028189	000028197	000028190	000028192	000028191	340x390x100
000028198	000028194	000028193	000028195	000028196	500x370x120

HEYDA





Putni program

WENGER
Torba/navlaka za laptop Legacy

- za 10,2" laptop/tablet
- zatvaranje na zip
- dimenzija: 295x219x19 mm
- dostupna u crnoj boji
- pakiranje: 1
- šifra: **000019062**

TUCANO
TECH&STYLE MILANO
Torba za laptop

- za 13" laptop, MacBook Pro, UltraBook 13"
- s ručkom za nošenje
- dimenzija: 370x260x70 mm
- dostupna u crnoj boji
- pakiranje: 1
- šifra: **000032280**

TUCANO
TECH&STYLE MILANO
Torba za laptop

- za 15" laptop, MacBook Pro 15"
- s ručkom za nošenje
- dimenzija: 420x290x30 mm
- dostupna u crnoj boji
- pakiranje: 1
- šifra: **000032281**

Kensington
Torba za laptop

- za 15,6" laptop
- postavljene ručke
- materijal neopren za zaštitu laptopa
- s više unutarnjih pretinaca
- dostupna u crnoj boji
- dimenzija: 390x340x60 mm
- pakiranje: 1
- šifra: **000031939**

Kensington
Torba za laptop Neoprene

- za 15,6" laptop
- sa zaštitnim pretincem za laptop
- s prednjim i stražnjim pretincima
- podstavljena podesiva naramenica
- dimenzija: 350x400x60 mm
- dostupna u crnoj boji
- pakiranje: 1
- šifra: **000024985**



TUCANO
TECH&STYLE MILANO

Torba za laptop Idea

- za 15,6" laptop
- s ručkom i remenom za nošenje
- zatvaranje na zip
- dimenzija: 420x280x70 mm
- dostupna u crnoj boji
- pakiranje: 1
- šifra: **000027087**



TUCANO
TECH&STYLE MILANO

Torba za laptop

- za 15,6" laptop
- s ručkom i remenom za nošenje
- dimenzija: 430x300x80 mm
- dostupna u crnoj boji
- pakiranje: 1
- šifra: **000032282**



TUCANO
TECH&STYLE MILANO

Torba za laptop

- za 15,6" laptop
- s ručkom i remenom za nošenje
- dimenzija: 400x295x85 mm
- dostupna u crnoj boji
- pakiranje: 1
- šifra: **000032279**



TUCANO
TECH&STYLE MILANO

Torba za laptop

- za 15,6" laptop
- s ručkom i remenom za nošenje
- dimenzija: 440x310x180 mm
- dostupna u crnoj boji
- pakiranje: 1
- šifra: **000032283**



Torba za laptop City Time

- za 15,6" laptop
- s vanjskim džepom
- podesivi remen
- dimenzija: 310x410x110 mm
- dostupna u crnoj boji
- pakiranje: 1
- šifra: **000029374**



TUCANO
TECH&STYLE MILANO

Torba za laptop

- na kotačićima
- za 15,6" laptop
- s ručkom za izvlačenje
- dimenzija: 420x380x200 mm
- dostupna u crnoj boji
- pakiranje: 1
- šifra: **000032288**



Torba za laptop

- na kotačićima
- za 15,6" laptop
- s ručkom za izvlačenje
- dimenzija: 460x400x260 mm
- dostupna u crnoj boji
- pakiranje: 1
- šifra: **000032287**



Verbatim**Torba za laptop Berlin**

- za 16" laptop i džepom za tablet
- lagana torba
- s vanjskim džepom
- podesivi remen
- dimenzija: 350x420x125 mm
- dostupna u crnoj boji
- pakiranje: 1
- šifra: **000024136**

**Verbatim****Torba za laptop Copenhagen**

- za 16" laptop
- na kotačiće
- sadrži veliki pretinac za odjeću i nesecer
- ima šifriranu bravu
- ergonomska ručka
- dimenzija: 385x450x250 mm
- dostupna u crnoj boji
- pakiranje: 1
- šifra: **000023951**

**Verbatim****Torba za laptop London**

- za 17" laptop s džepom za tablet
- zatvaranje na zip
- ergonomska meka ručka
- dimenzija: 315x445x80 mm
- dostupna u crnoj boji
- pakiranje: 1
- šifra: **000024135**





Kensington

Torba za laptop SP45

- za 17" laptop
- ergonomska ručka i remen
- 1 odjeljak i 2 vanjska džepa na zip
- dimenzija: 450x360x165 mm
- dostupna u crnoj boji
- pakiranje: 1
- šifra: **000015466**

TUCANO

TECH&STYLE MILANO



Torba za laptop

- za 17" laptop
- s ručkom i remenom za nošenje
- poseban pretinac za tablet
- dimenzija: 477x300x70 mm
- dostupna u crnoj boji
- pakiranje: 1
- šifra: **000032278**

RUKSACI ZA LAPTOP



Kensington

Ruksak za laptop

- za 15,6" laptop
- s više unutarnjih pretinaca
- dostupna u crnoj boji
- dimenzija: 500x330x130 mm
- pakiranje: 1
- šifra: **000028633**

TUCANO

TECH&STYLE MILANO



Ruksak za laptop

- za 15,6" laptop
- dimenzija: 320x470x180 mm
- dostupna u crnoj boji
- pakiranje: 1
- šifra: **000029949**

TUCANO

TECH&STYLE MILANO

Ruksak za laptop Svago

- za 15,6" laptop s džepom za iPad do 10"
- lagani ruksak koji odgovara urbanom načinu života
- podesive naramenice
- patentni zatvarač
- dimenzija: 330x470x150 mm
- dostupan u crno-sivoj boji
- pakiranje: 1
- šifra: **000027088**



TUCANO
TECH&STYLE MILANO

Ruksak za laptop

- za 15,6" laptop
- dimenzija: 330x480x180 mm
- dostupna u crnoj boji
- pakiranje: 1
- šifra: **000032285**



TUCANO
TECH&STYLE MILANO

Ruksak za laptop

- za 15,6" laptop
- dimenzija: 350x490x185 mm
- dostupna u crnoj boji
- pakiranje: 1
- šifra: **000032286**



Verbatim

Ruksak za laptop Stockholm

- za 16" laptop
- lagani ruksak s ekstra velikim pretincem i džepom za tablet
- stražnja podstava koja omogućava protok zraka
- udobni podesivi remeni za ramena i prsni remen
- dimenzija: 365x450x210 mm
- dostupan u crnoj boji
- pakiranje: 1
- šifra: **000024137**



Verbatim

Ruksak za laptop Melbourne

- za 16" laptop
- lagani ruksak s džepom za tablet
- stražnja podstava koja omogućava protok zraka
- udobni podesivi remeni za ramena i prsni remen
- dimenzija: 355x450x210 mm
- dostupan u crnoj boji
- pakiranje: 1
- šifra: **000024138**

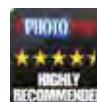

**Torba poslovna City Time**

- platnena s kožnom ručkom
- podesivi remen
- dostupna u crnoj boji
- dimenzija: 300x420x110 mm
- pakiranje: 1
- šifra: **000029376**

**Torba poslovna City Time**

- kombinacija koža/platno
- podesivi remen
- dostupna u crnoj boji
- dimenzija: 310x410x150 mm
- pakiranje: 1
- šifra: **000029377**

**Torba poslovna Meeting**

- platnena s kožnom ručkom
- podesivi remen
- dostupna u crnoj boji
- dimenzija: 280x410x60 mm
- pakiranje: 1
- šifra: **000029375**

NESESERI

**Neseser**

- muški kožni nesoser
- dostupan u crnoj i smeđoj boji
- dimenzija: 160x230x50 mm
- pakiranje: 1



• 000014116



• 000014117

**Neseser**

- muški kožni nesoser
- dostupan u crnoj i smeđoj boji
- dimenzija: 140x270x120 mm
- pakiranje: 1



• 000020885



• 000020883

**Neseser**

- ženski nesoser
- kombinacija kožna/platno
- dostupan u crnoj i smeđoj boji
- dimenzija: 160x230x40 mm
- pakiranje: 1



• 000020886



• 000020887

**Torba kožna**

- muška torba
- dostupna u crnoj i smeđoj boji
- dimenzija: 270x415x115 mm
- pakiranje: 1



• 000023026



• 000023027

**Torba kožna**

- muška torba
- dostupna u crnoj i smeđoj boji
- dimenzija: 320x400x60 mm
- pakiranje: 1



• 000023032



• 000025061

**Torba kožna**

- muška torba
- dostupna u crnoj i smeđoj boji
- dimenzija: 350x430x100 mm
- pakiranje: 1



• 000025065



• 000025064

**Torba kožna**

- muška torba
- dostupna u crnoj i smeđoj boji
- dimenzija: 300x400x110 mm
- pakiranje: 1



• 000010866



• 000010865

**Torba kožna**

- muška torba
- dostupna u smeđoj boji
- dimenzija: 320x400x60 mm
- pakiranje: 1
- šifra: 000011763

**Torba kožna**

- muška torba
- dostupna u crnoj boji
- dimenzija: 310x410x110 mm
- pakiranje: 1
- šifra: 000010140

**Torba poslovna Tempora**

- muška kožna torba
- dostupna u crnoj boji
- dimenzija: 41x31x12 cm
- pakiranje: 1
- šifra: 000031828



• 000010141

**Torba kožna**

- muška torba
- s dodatnim remenom preko ramena
- dostupna u crnoj i smeđoj boji
- dimenzija: 330x270x110 mm
- pakiranje: 1



• 000010142

**Torba kožna**

- muška torba
- dostupna u smeđoj boji
- dimenzija: 220x280x90 mm
- pakiranje: 1
- šifra: **000012018**



• 000020894

**Torba kožna**

- muška torba
- s dodatnim remenom preko ramena
- dostupna u crnoj i smeđoj boji
- dimenzija: 270x230x80 mm
- pakiranje: 1



• 000020895



• 000020891

**Torba kožna**

- muška torba
- s dodatnim remenom preko ramena
- dostupna u crnoj i smeđoj boji
- dimenzija: 210x170x100 mm
- pakiranje: 1

• 000020892

**Torba preko ramena Tempora**

- muška kožna torba
- dostupna u smeđoj boji
- dimenzija: 260x270x80 mm
- pakiranje: 1
- šifra: **000031829**

**Torba kožna**

- muška torba
- s dodatnim remenom preko ramena
- dostupna u crnoj boji
- dimenzija: 200x170x50 mm
- pakiranje: 1
- šifra: **000023030**



• 000020890

**Torba kožna**

- muška torba
- s dodatnim remenom preko ramena
- dostupna u crnoj i smeđoj boji
- dimenzija: 160x160x60 mm
- pakiranje: 1



• 000020889

**Torba kožna**

- ženska torba
- dostupna u crnoj i smeđoj boji
- dimenzija: 340x260x180 mm
- pakiranje: 1



• 000029191



• 000029190

**Torba kožna**

- ženska torba
- dostupna u crnoj i smeđoj boji
- dimenzija: 300x400x115 mm
- pakiranje: 1



• 000025062



• 000025063

**Torba kožna Kroko**

- ženska torba
- dostupna u smeđoj boji
- dimenzija: 290x360x130 mm
- pakiranje: 1
- šifra: **000014119**

**Torba kožna**

- ženska torba
- dostupna u crnoj boji
- dimenzija: 280x350x100 mm
- pakiranje: 1
- šifra: **000011756**



**Torba kožna**

- ženska torba
- dostupna u crnoj boji
- dimenzija: 380x280x130 mm
- pakiranje: 1
- šifra: **000029205**



• 000029194

**Torba kožna**

- ženska torba
- dostupna u crnoj i smeđoj boji
- dimenzija: 360x280x110 mm
- pakiranje: 1

• 000029195

**Torba kožna**

- ženska torba
- dostupna u crnoj boji
- dimenzija: 290x360x130 mm
- pakiranje: 1
- šifra: **000010137**

**Torba kožna**

- ženska torbica preko ramena
- sort boje
- dimenzija: 180x170 mm
- pakiranje: 1
- šifra: **000025978**



• 000029199

**Torba kožna**

- ženska torbica preko ramena
- dostupna u crnoj i smeđoj boji
- dimenzija: 260x240x140 mm
- pakiranje: 1

• 000029198



TORBE KOŽNE ŽENSKE



• 000029193

**Torba kožna**

- ženska torbica preko ramena
- dostupna u plavoj i sivoj boji
- dimenzija: 300x230x160 mm
- pakiranje: 1



• 000029192

NOVČANICI MUŠKI

**Novčanik/etui**

- muški kožni novčanik
- RFID
- dostupan u crnoj boji
- dimenzija: 70x90x15 mm
- pakiranje: 1
- šifra: **000033681**

**Novčanik**

- muški kožni novčanik
- RFID
- dostupan u crnoj boji
- dimenzija: 90x120x10 mm
- pakiranje: 1
- šifra: **000033678**



RFID novčanici blokiraju signale kartice, te na taj način sprječavaju krađu podataka sa iste. Štiti 100% od svih poznatih RFID/NFC frekvencija.

**Novčanik**

- muški kožni novčanik
- dostupan u crnoj i smeđoj boji
- dimenzija: 90x120x10 mm
- pakiranje: 1

• 000023028



• 000023029

**Novčanik**

- muški kožni novčanik
- dostupan u smeđoj boji
- dimenzija: 90x120x10 mm
- pakiranje: 1
- šifra: **000010845**





• 000018820

**Novčanik**

- muški kožni novčanik
- dostupan u crnoj i smeđoj boji
- dimenzija: 90x120x10 mm
- pakiranje: 1



• 000020487

**Novčanik**

- muški kožni novčanik
- dostupan u crnoj boji
- dimenzija: 90x125x15 mm
- pakiranje: 1
- šifra: 000033677



• 000025141

**Novčanik**

- muški kožni novčanik
- dostupan u crnoj i smeđoj boji
- dimenzija: 120x90 mm
- pakiranje: 1



• 000025921

**Novčanik**

- muški kožni novčanik
- dostupan u crnoj boji
- dimenzija: 120x90 mm
- pakiranje: 1
- šifra: 000027169



• 000030604

**Novčanik**

- muški kožni novčanik
- dostupan u crnoj i smeđoj boji
- dimenzija: 120x90 mm
- pakiranje: 1



• 000030603

**Novčanik**

- muški kožni novčanik
- dostupan u crnoj boji
- dimenzija: 120x110 mm
- pakiranje: 1
- šifra: 000025143



• 000025948

Novčanik Valentini Luxury

- muški kožni novčanik
- dostupan u crnoj i smeđoj boji
- dimenzija: 120x100 mm
- pakiranje: 1



• 000025949

**Novčanik Sergio Tacchini**

- muški kožni novčanik
- dostupan u smeđoj boji
- dimenzija: 120x90 mm
- pakiranje: 1
- šifra: 000030660



• 000033680



• 000033679

Novčanik

- muški kožni novčanik
- RFID
- dostupan u crvenoj i tamno plavoj boji
- dimenzija: 100x200x30 mm
- pakiranje: 1



• 000033155



• 000033154

**Novčanik**

- ženski kožni novčanik
- dostupan u crnoj i crvenoj boji
- dimenzija: 170x110x40 mm
- pakiranje: 1



• 000028104



• 000028106



• 000028105

Novčanik

- ženski kožni novčanik
- dostupan u 3 uzorka
- pakiranje: 1



• 000026174



• 000026175



• 000026177

Novčanik

- ženski kožni novčanik
- dostupan u 3 boje
- pakiranje: 1



• 000026181



• 000026178



• 000023036

Novčanik

- ženski kožni novčanik
- dostupan u 6 boja
- dimenzija: 100x200x30 mm
- pakiranje: 1

• 000026180

• 000026179

• 000026182

**Novčanik**

- ženski kožni novčanik
- sort boje
- pakiranje: 1
- šifra: **000028100**

**Novčanik**

- ženski kožni novčanik
- sort boje
- dimenzija: 140x100x20 mm
- pakiranje: 1
- šifra: **000025974**

**Novčanik**

- ženski kožni novčanik
- dostupan u crnoj, crvenoj i smeđoj boji
- dimenzija: 180x110 mm
- pakiranje: 1



• 000022917



• 000022915



• 000022916

**Novčanik**

- ženski kožni novčanik
- dostupan u crnoj, smeđoj i crvenoj boji
- dimenzija: 125x95 mm
- pakiranje: 1



• 000022937



• 000022939



• 000022938

**Novčanik**

- ženski kožni novčanik
- dostupan u crvenoj boji
- dimenzija: 130x100 mm
- pakiranje: 1
- šifra: **000030661**

**Novčanik**

- ženski kožni novčanik
- dostupan u crvenoj boji
- dimenzija: 130x100 mm
- pakiranje: 1
- šifra: **000030631**



EMPORIO VALENTINI

Novčanik

- ženski kožni novčanik
- dostupan u crnoj, smeđoj i crvenoj boji
- dimenzija: 180x110 mm
- pakiranje: 1



• 000025919



• 000025918



• 000016622

Novčanik Valentini Luxury

- ženski kožni novčanik
- dostupan u crnoj, smeđoj i crvenoj boji
- dimenzija: 175x105 mm
- pakiranje: 1



• 000030595



• 000025962



• 000025961

ETUI

**Etui za pametni telefon**

- kožni etui za mobitel 5", kartice i novac
- 6 mjesta za kartice
- dostupan u crnoj, plavoj, crvenoj i smeđoj boji
- dimenzija: 155x85x20 mm
- pakiranje: 1

 • 000030420

 • 000030419

 • 000030421

 • 000027388
**Etui**

- kožni etui za mobitel 4", kartice i novac
- 5 mjesta za kartice
- dostupan u crnoj boji
- dimenzija: 140x70x20 mm
- pakiranje: 1
- šifra: **000027389**

**Etui za pametni telefon**

- kožni etui s zipom
- uz njega dolazi manji etui za kreditne kartice
- dostupan u plavoj, smeđoj i crnoj boji
- dimenzija: 160x95x18 mm
- pakiranje: 1

 • 000030422

 • 000030423

 • 000030418

RUKAVICE MUŠKE



Rukavice

- muške kožne rukavice
- dostupne u crnoj boji
- veličina: XL
- pakiranje: 1
- šifra: **000030960**



Rukavice

- muške kožne rukavice
- dostupne u crnoj boji
- veličina: XXL
- pakiranje: 1
- šifra: **000030961**

RUKAVICE ŽENSKE



Rukavice

- ženske kožne rukavice
- dostupne u crnoj boji
- veličina: L
- pakiranje: 1
- šifra: **000029352**



Rukavice

- ženske kožne rukavice
- dostupne u crnoj boji
- veličina: XL
- pakiranje: 1
- šifra: **000029353**



Rukavice

- ženske kožne rukavice
- dostupne u tamno plavoj boji
- veličina: L
- pakiranje: 1
- šifra: **000029356**



Rukavice

- ženske kožne rukavice
- dostupne u tamno plavoj boji
- veličina: XL
- pakiranje: 1
- šifra: **000029357**



Rukavice

- ženske kožne rukavice
- dostupne u crnoj boji
- veličina: L
- pakiranje: 1
- šifra: **000030956**



Rukavice

- ženske kožne rukavice
- dostupne u crnoj boji
- veličina: XL
- pakiranje: 1
- šifra: **000030957**



Rukavice

- ženske kožne rukavice
- dostupne u crnoj boji
- veličina: L
- pakiranje: 1
- šifra: **000030958**



Rukavice

- ženske kožne rukavice
- dostupne u crnoj boji
- veličina: XL
- pakiranje: 1
- šifra: **000030959**

**Remen**

- muški kožni remen
- dostupan u crnoj i smeđoj boji
- širina: 30 mm
- dužina: 105-135 cm
- pakiranje: 1



• 000010144



• 000011780

**Remen**

- muški kožni remen
- dostupan u crnoj i smeđoj boji
- širina: 30 mm
- dužina: 105-135 cm
- pakiranje: 1



• 000023039



• 000023040

**Remen**

- muški kožni remen
- dostupan u smeđoj boji
- širina: 35 mm
- dužina: 105-135 cm
- pakiranje: 1
- šifra: **000023047**

**Remen**

- muški kožni remen
- dostupan u crnoj i smeđoj boji
- širina: 40 mm
- dužina: 105-135 cm
- pakiranje: 1



• 000023048



• 000023049

**Remen**

- muški kožni remen
- dostupan u crnoj boji
- širina: 40 mm
- dužina: 105-135 cm
- pakiranje: 1
- šifra: **000025075**





Remen

- muški kožni remen
- dostupan u crnoj i smeđoj boji
- širina: 40 mm
- pakiranje: 1



• 000031225



• 000031226



Remen

- muški kožni remen
- dostupan u crnoj i smeđoj boji
- širina: 40 mm
- pakiranje: 1



• 000031227



• 000031228



Pieme Cardin

Remen

- muški kožni remen
- dostupan u crnoj boji
- širina: 35 mm
- pakiranje: 1
- šifra: 000031692



Pieme Cardin

Remen

- muški kožni remen
- dostupan u crnoj boji
- širina: 35 mm
- pakiranje: 1
- šifra: 000028963



Pieme Cardin

Remen

- muški kožni remen
- dostupan u crnoj boji
- širina: 35 mm
- pakiranje: 1
- šifra: 000028968



Pieme Cardin

Remen

- muški kožni remen
- dostupan u crnoj boji
- širina: 35 mm
- pakiranje: 1
- šifra: 000028966



Pieme Cardin

Remen

- muški kožni remen
- dostupan u crnoj boji
- širina: 35 mm
- pakiranje: 1
- šifra: 000028967

REMENI ŽENSKI



Remen Kroko

- ženski kožni remen
- dostupan u crnoj i smeđoj boji
- širina: 25 mm
- pakiranje: 1



• 000023044



• 000023045



Remen

- ženski kožni remen
- dostupan u smeđoj boji
- širina: 39 mm
- pakiranje: 1
- šifra: 000025216



Remen

- ženski kožni remen
- dostupan u crnoj boji
- širina: 39 mm
- pakiranje: 1
- šifra: 000025217



Remen

- ženski kožni remen
- dostupan u smeđoj boji
- širina: 39 mm
- pakiranje: 1
- šifra: 000025218



Remen

- ženski kožni remen
- dostupan u crnoj boji
- širina: 29 mm
- pakiranje: 1
- šifra: 000023986



Remen

- ženski kožni remen
- dostupan u crnoj boji
- širina: 25 mm
- pakiranje: 1
- šifra: 000025215



POKLON SETOVI

fornax

Set muški

- kožni set u drvenoj kutiji
- sadrži novčanik i olovku kemijsku Faber-Castell grip
- dostupan u crnoj i smeđoj boji
- pakiranje: 1



• 000013054



• 000013056

fornax

Set muški

- kožni set u drvenoj kutiji
- sadrži novčanik i remen
- dostupan u crnoj i smeđoj boji
- pakiranje: 1



• 000013062



• 000013063

Veći asortiman setova možete vidjeti u našem Promotivnom katalogu.



• 000013064

• 000013067



• 000013042

• 000013041

fornax

Set muški

- kožni set u drvenoj kutiji
- sadrži novčanik, remen i kravatu
- dostupan u crnoj i smeđoj boji
- pakiranje: 1

fornax

Set ženski

- kožni set u drvenoj kutiji
- sadrži novčanik i maramu
- dostupan u crnoj i smeđoj boji
- pakiranje: 1

fornax

Set ženski

- kožni set u drvenoj kutiji
- sadrži novčanik, maramu i olovku kemijsku Faber-Castell Polly Ball
- dostupan u crnoj boji
- pakiranje: 1
- šifra: **000013043**



fornax

Set ženski

- kožni set u drvenoj kutiji
- sadrži novčanik i rukavice
- dostupan u crnoj boji
- pakiranje: 1
- šifra: **000013045**



KIŠOBRANI

Kišobran

- 63 cm
- drvena ručka
- automatsko otvaranje
- dostupan u raznim bojama
- pakiranje: 12



• 000011914



• 000013011



• 000010899



• 000013012



• 000019119



• 000010898



• 000011014



Kišobran Tourist

- dužina zatvorenog kišobrana 90 cm, Ø105 cm
- automatsko otvaranje
- otporan na vjetar
- dostupan u crnoj boji
- pakiranje: 1
- šifra: **000022287**



Kišobran Long AC Dots

- dužina zatvorenog kišobrana 85 cm, Ø100 cm
- automatsko otvaranje
- dostupan u u sort bojama s bijelim točkicama
- pakiranje: 1
- šifra: **000023604**



Kišobran Up And Down

- dužina zatvorenog kišobrana 30 cm, Ø95 cm
- automatsko otvaranje i zatvaranje
- s navlakom
- otporan na vjetar
- dostupan u plavoj boji
- pakiranje: 1
- šifra: **000022302**



Kišobran Mini-AC Flash Uni

- dužina zatvorenog kišobrana 30 cm, Ø95 cm
- automatsko otvaranje
- s navlakom
- otporan na vjetar
- dostupan u u sort bojama
- pakiranje: 1
- šifra: **000023602**



Kišobran Mini-AC

- dužina zatvorenog kišobrana 25 cm, Ø95 cm
- automatsko otvaranje
- s navlakom
- otporan na vjetar
- dostupan u crnoj boji
- pakiranje: 1
- šifra: **000022292**



Kišobran Super-Mini Uni

- dužina zatvorenog kišobrana 25 cm, Ø100 cm
- ručno otvaranje
- s navlakom
- dostupan u sort bojama
- pakiranje: 1
- šifra: **000022297**



Kišobran Gen's Super-mini

- dužina zatvorenog kišobrana 25 cm, Ø100 cm
- ručno otvaranje
- s navlakom
- dostupan u crnoj boji
- pakiranje: 1
- šifra: **000022305**



Kišobran Ultra Mini Flash Dots

- dužina zatvorenog kišobrana 15 cm, Ø85 cm
- ručno otvaranje
- s navlakom
- otporan na vjetar
- dostupan u sort bojama s bijelim točkicama
- pakiranje: 1
- šifra: **000023607**





ESPRIT

Kišobran Long AC

- dužina zatvorenog kišobrana 87 cm, Ø105 cm
- automatsko otvaranje
- dostupan u crvenoj i tamno plavoj boji
- pakiranje: 1

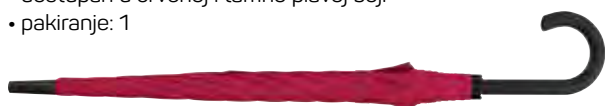

• 000027217



• 000027218



ESPRIT

Kišobran Golf

- dužina zatvorenog kišobrana 95,5 cm, Ø130 cm
- automatsko otvaranje
- dostupan u crvenoj i crnoj boji
- pakiranje: 1



• 000027220



• 000027219

ESPRIT

Kišobran Gents Long AC

- dužina zatvorenog kišobrana 90 cm, Ø120 cm
- automatsko otvaranje
- dostupan u crnoj boji
- pakiranje: 1
- šifra: 000027229



ESPRIT

Kišobran Basic Long AC

- dužina zatvorenog kišobrana 87 cm, Ø103 cm
- automatsko otvaranje
- dostupan u crnoj boji
- pakiranje: 1
- šifra: 000027216



ESPRIT

Kišobran Gent's Mini Tecmatic

- dužina zatvorenog kišobrana 28 cm, Ø99 cm
- automatsko otvaranje
- s navlakom
- dostupan u crnoj i plavoj boji
- pakiranje: 1



• 000031555



• 000031556

ESPRIT

Kišobran Mini Basic

- dužina zatvorenog kišobrana 24 cm, Ø95 cm
- ručno otvaranje
- dostupan u sort bojama
- pakiranje: 12
- šifra: 000031554



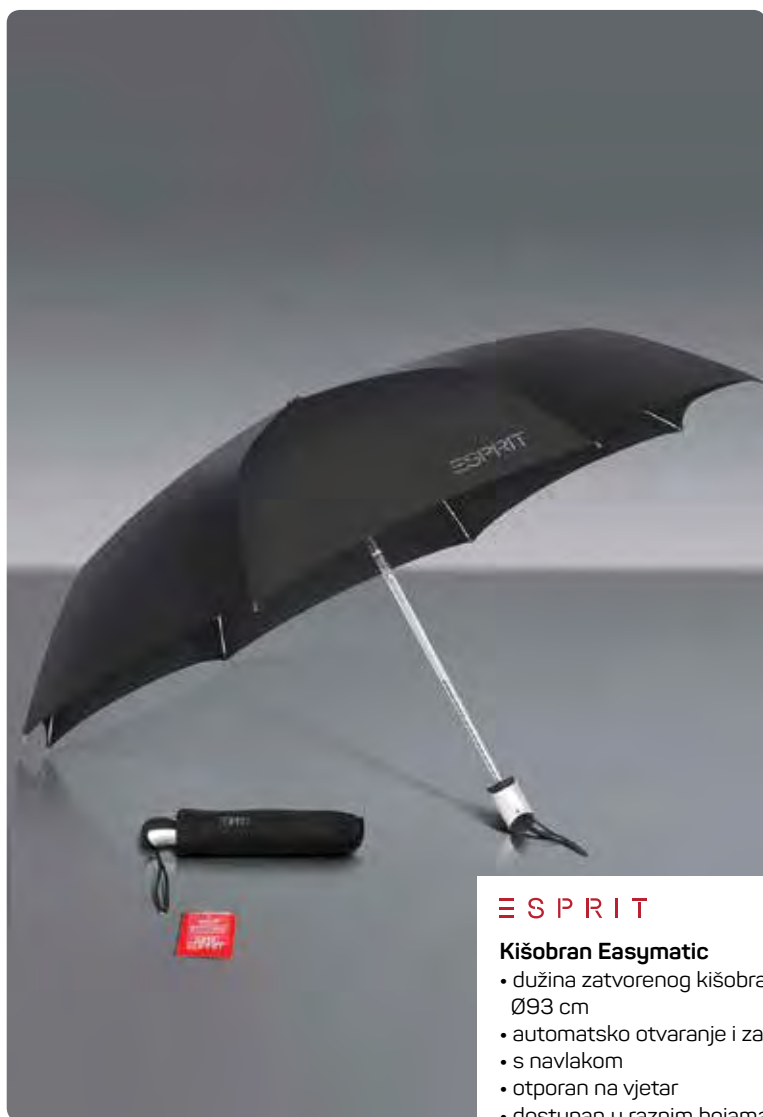

ESPRIT

Kišobran Easymatic

- dužina zatvorenog kišobrana 21,5 cm, Ø93 cm
- automatsko otvaranje i zatvaranje
- s navlakom
- otporan na vjetar
- dostupan u raznim bojama
- pakiranje: 1



• 000027223



• 000027224



• 000027222



• 000031551



• 000031552



• 000031553

ESPRIT

Kišobran Basic

- dužina zatvorenog kišobrana 24 cm, Ø95 cm
- ručno otvaranje
- s navlakom
- dostupan u crnoj boji
- pakiranje: 1
- šifra: 000027215



ESPRIT

Kišobran Diamond Petito

- dužina zatvorenog kišobrana 15,7 cm, Ø93 cm
- automatsko otvaranje
- s navlakom
- otporan na vjetar
- dostupan u crnoj boji
- pakiranje: 1
- šifra: 000027221



pierre cardin

Kišobran Long AC

- dužina zatvorenog kišobrana 88,5 cm, Ø104 cm
- automatsko otvaranje
- dostupan u crnoj boji
- pakiranje: 1
- šifra: 000027213



pierre cardin

Kišobran Golf AC

- dužina zatvorenog kišobrana 97 cm, Ø118 cm
- automatsko otvaranje
- drvena ručka
- dostupan u crnoj boji
- pakiranje: 1
- šifra: 000027214





||| S P R I T





50 Years of Trusted Technology



Your data is very precious. Whether it is confidential personal information you need protecting or photos and documents you cannot afford to lose - it is always better save it on technology you can trust.

For over 50 years our mission has been to develop trusted solutions to enrich the daily lives of our customers. From floppy disks, magneto-optical storage, CD, DVD and Blu-ray media, to external hard drives, memory cards, USB drives and SSDs - the extent of Verbatim's extensive portfolio and influence in the storage industry is unrivalled



Punjenje za 3D pisač PLA

- napravljena je od materijala vrhunske kakvoće za dosljedno punjenje i stabilne ispise
- PLA (polimljična kiselina) nit je razgradiva bioplastika proizvedena iz kukuruza
- ne sadržava teške metale, ftalate ili Bisfenol A (BPA)
- pogodna za velik izbor 3D pisača
- sve niti isporučuju se namotane na kalem u vakumskoj vreći sa sredstvom za sušenje
- nije potrebno grijano postolje
- temperatura postupka: 200-220 °C (preporučena)
- promjer kalema: 200 mm
- dubina kalema: 72 mm
- promjer glavine: 102 mm

Šifra	Boja	Promjer niti	Masa	Dužina niti
000025690	bijela	1,75 mm	1 kg	334 m
000025689	crna	1,75 mm	1 kg	334 m
000025692	crvena	1,75 mm	1 kg	334 m
000025694	narančasta	1,75 mm	1 kg	334 m
000025691	plava	1,75 mm	1 kg	334 m
000025696	prozirna	1,75 mm	1 kg	334 m
000025697	srebrna	1,75 mm	1 kg	334 m
000025693	zelena	1,75 mm	1 kg	334 m
000025695	žuta	1,75 mm	1 kg	334 m
000025712	bijela	2,85 mm	1 kg	119 m
000025711	crna	2,85 mm	1 kg	119 m
000025714	crvena	2,85 mm	1 kg	119 m
000025713	plava	2,85 mm	1 kg	119 m
000025717	prozirna	2,85 mm	1 kg	119 m
000025718	srebrna	2,85 mm	1 kg	119 m
000025715	zelena	2,85 mm	1 kg	119 m
000025716	žuta	2,85 mm	1 kg	119 m



Punjenje za 3D pisač ABS

- ABS (akrilonitril butadien stiren) nit je kopolimer koji se sastoji od stirena, akrila i butadiena
- čvrsta je i otporna na udarce
- pogodna za velik izbor 3D pisača
- sve niti isporučuju se namotane na kalem u vakumskoj vreći sa sredstvom za sušenje
- preporučuje se upotreba grijanog postolja
- temperatura postupka: 230-240 °C (preporučena)
- promjer kalema: 200 mm
- dubina kalema: 72 mm
- promjer glavine: 102 mm
- promjer rupe glavine: 51 mm

Šifra	Boja	Promjer niti	Masa	Dužina niti
000025708	bijela	1,75 mm	750 g	-
000025707	crna	1,75 mm	750 g	-
000025699	bijela	1,75 mm	1 kg	404 m
000025698	crna	1,75 mm	1 kg	404 m
000025703	crvena	1,75 mm	1 kg	404 m
000025702	plava	1,75 mm	1 kg	404 m
000025705	prozirna	1,75 mm	1 kg	404 m
000025706	srebrna	1,75 mm	1 kg	404 m
000025704	zelena	1,75 mm	1 kg	404 m
000025720	bijela	2,85 mm	1 kg	-
000025719	crna	2,85 mm	1 kg	-
000025721	prozirna	2,85 mm	1 kg	-



MODEL

DCP 110C/115C
DCP 130C
DCP 135C/150C
DCP 145C/165C
DCP 310CN
DCP 330C/350C/357C
DCP 375W
DCP 385C
DCP 540CN/560CN
DCP 585CW
DCP 750CW/770CW
DCP 6690CW
MFC 210C/215C
MFC 235C/260C

ŠIFRA	NAZIV	KAPACITET	BOJA	DCP 110C/115C	DCP 130C	DCP 135C/150C	DCP 145C/165C	DCP 310CN	DCP 330C/350C/357C	DCP 375W	DCP 385C	DCP 540CN/560CN	DCP 585CW	DCP 750CW/770CW	DCP 6690CW	MFC 210C/215C	MFC 235C/260C
000009643	LC 600 BK	950 str.	crna														
000009644	LC 600 C	450 str.	plava														
000009645	LC 600 M	450 str.	crvena														
000009646	LC 600 Y	450 str.	žuta														
000009667	LC 800 BK	500 str.	crna														
000009668	LC 800 C	400 str.	plava														
000009669	LC 800 M	400 str.	crvena														
000009670	LC 800 Y	400 str.	žuta														
000009730	LC 900BK	500 str.	crna	●				●								●	
000010016	LC 900C	400 str.	plava	●				●								●	
000010015	LC 900M	400 str.	crvena	●				●								●	
000010017	LC 900Y	400 str.	žuta	●				●								●	
-	LC 970BK	350 str.	crna			●											●
-	LC 970C	300 str.	plava			●											●
-	LC 970M	300 str.	crvena			●											●
-	LC 970Y	300 str.	žuta			●											●
000019825	LC 980BK	350 str.	crna				●			●							
000019836	LC 980C	300 str.	plava				●			●							
000019837	LC 980M	300 str.	crvena				●			●							
000019835	LC 980Y	300 str.	žuta				●			●							
-	LC 1000BK	500 str.	crna	●					●			●		●			
-	LC 1000C	400 str.	plava	●					●			●		●			
-	LC 1000M	400 str.	crvena	●					●			●		●			
-	LC 1000Y	400 str.	žuta	●					●			●		●			
-	LC 1100BK	450 str.	crna								●		●		●		
-	LC 1100C	325 str.	plava								●		●		●		
-	LC 1100M	325 str.	crvena								●		●		●		
-	LC 1100Y	325 str.	žuta								●		●		●		
000023324	LC-1280 BK XL	2400 str.	crna														
000023323	LC-1280 C XL	1200 str.	plava														
000023322	LC-1280 M XL	1200 str.	crvena														
000023321	LC-1280 Y XL	1200 str.	žuta														





ŠIFRA	NAZIV	KAPACITET	BOJA	ZA KOPIRNE APARATE															
				MODEL	CLC 200/300/320/350	CLC 700/800/900/950	CLC 2620	CLC 3200/ 3230	CLC 3620	FC 100/120	FC 200/204/210/220/224/230	FC 310/330/336/530	GP 210/215/220/225	GP 285/300/335/400/405	GP 555/605	IR ADV 400/500i	IR 1018/1020/1022	IR 1200/1207/1210/1230/1270	IR 1510/1530/1570
00000913	A30	3000 str.	crna																
00000276	C-EXV 1	33000 str.	crna																
000007803	C-EXV 3	15000 str.	crna																
000003041	C-EXV 5	2x7850 str.	crna																●
000008754	C-EXV 6	6900 str.	crna																
000009657	C-EXV 7	5300 str.	crna													●	●		
000015323	C-EXV 8BK	18000 str.	crna			●	●	●											
000015324	C-EXV 8C	20000 str.	plava			●	●	●											
-	C-EXV 8M	20000 str.	crvena			●	●	●											
000014806	C-EXV 8Y	20000 str.	žuta			●	●	●											
000001773	C-EXV 9BK	23000 str.	crna																
000001775	C-EXV 9C	8500 str.	plava																
000001774	C-EXV 9M	8500 str.	crvena																
000001780	C-EXV 9Y	8500 str.	žuta																
000027969	C-EXV 49B	36000 str.	crna																
000027970	C-EXV 49C	19000 str.	plava																
000027973	C-EXV 49M	19000 str.	crvena																
000027974	C-EXV 49Y	19000 str.	žuta																
000009482	C-EXV 11	21000 str.	crna																
000009488	C-EXV 12	24000 str.	crna																
000010128	C-EXV 13	45000 str.	crna																
000009847	C-EXV 14 2/1	2x 8300 str.	crna																
000011344	C-EXV 18	8400 str.	crna													●			
000011547	C-EXV 21BK	26000 str.	crna																
000011549	C-EXV 21M	26000 str.	crvena																
000011548	C-EXV 21C	26000 str.	plava																
000011550	C-EXV 21Y	26000 str.	žuta																
000014024	C-EXV 22	48000 str.	crna																
000016194	C-EXV 24BK	48000 str.	crna																
000016195	C-EXV 24Y	9500 str.	žuta																
-	C-EXV 24C	9500 str.	plava																
-	C-EXV 24M	9500 str.	crvena																
000015683	C-EXV 33	14600 str.	crna																
000006190	CLC-300M	4000 str.	crvena	●															
000029174	C-EXV 43	4000 str.	crna												●				
000024758	FM3-9276-000																		



MODEL

i560
i865
i905di/i950/i965/i990/i9100/i9950
Pixma iP100/iP110
Pixma iP1000/iP1500/iP2000
Pixma iP1300/iP1600/iP1700
Pixma iP1800
Pixma iP2200
Pixma iP2500
Pixma iP3000
Pixma iP3500
Pixma iP4850/i4900/i4950
Pixma iP3600/i4600
Pixma iP4000/iP5000
Pixma iP4200/iP4500/iP5200
Pixma iP6000/iP8500

ŠIFRA	NAZIV	KAPACITET	BOJA	i560	i865	i905di/i950/i965/i990/i9100/i9950	Pixma iP100/iP110	Pixma iP1000/iP1500/iP2000	Pixma iP1300/iP1600/iP1700	Pixma iP1800	Pixma iP2200	Pixma iP2500	Pixma iP3000	Pixma iP3500	Pixma iP4850/i4900/i4950	Pixma iP3600/i4600	Pixma iP4000/iP5000	Pixma iP4200/iP4500/iP5200	Pixma iP6000/iP8500	
000004240	BC-20BK	900 str.	crna																	
-	BC-21C	3500 str.	color																	
000002834	BCI-3BK	420 str.	crna	•	•								•					•		
000000170	BCI-3C	390 str.	plava																	
000001492	BCI-3M	390 str.	crvena																	
000003738	BCI-3Y	390 str.	žuta																	
000000761	BCI-6BK	280 str.	crna		•	•												•		•
000000762	BCI-6C	280 str.	plava	•	•	•							•					•		•
000000765	BCI-6M	280 str.	crvena	•	•	•							•					•		•
000000763	BCI-6Y	280 str.	žuta	•	•	•							•					•		•
-	BCI-6PC	280 str.	plava			•														•
-	BCI-6PM	280 str.	crvena			•														•
000004004	BCI-21BK	140 str.	crna																	
000005694	BCI-21E	100 str.																		
000004006	BCI-21C	100 str.	color																	
000007952	BCI-24BK	320 str.	crna					•												
000007953	BCI-24C	170 str.	color					•												
000014624	BCI-1431BK	130 ml	crna																	
000014609	BCI-1431M	130 ml	crvena																	
000014625	BCI-1431C	130 ml	plava																	
000014626	BCI-1431Y	130 ml	žuta																	
000014524	BCI-1431PM	130 ml	photo crvena																	
000014523	BCI-1431PC	130 ml	photo plava																	
000025820	CLI-551G XL	670 str.	siva																	
000025880	CLI-36	249 str.	color			•														
000012318	CL-38C	3X3 ml	color							•		•								
000010047	CL-41C	3X4 ml	color							•	•	•	•							
-	CL-51C	3X7 ml	color									•								
000014275	CL-511C	244 str.	color																	
000010165	CLI-8BK	13 ml	crna																	•
000010162	CLI-8G	13 ml	zelena											•						•
000010166	CLI-8M	13 ml	crvena											•						•
000010167	CLI-8Y	13 ml	žuta											•						•
000014120	CLI-8PC	13 ml	photo plava																	
000014121	CLI-8PM	13 ml	photo crvena																	
000014122	CLI-8M	13 ml	crvena																	
000014123	CLI-8G	13 ml	zelena																	



MODEL

ŠIFRA	NAZIV	KAPACITET	BOJA	Pixma iP100	Pixma iP1300/iP1600/iP1700	Pixma iP1800	Pixma iP2200	Pixma iP2500	Pixma iP3500	Pixma iP4850/4900/4950	Pixma iP3600/4600	Pixma iP4000/iP5000	Pixma iP4200/iP4500/iP5200	Pixma iX6500/iX5500	Pixma iX4000/iX5000	Pixma MP110/MP130	Pixma MP150/MP160/MP170/MP180
000013842	CLI-521BK	9 ml	crna														
000013843	CLI-521C	9 ml	plava														
-	CLI-521G	9 ml	zelena														
000013844	CLI-521M	9 ml	crvena														
000013845	CLI-521Y	9 ml	žuta														
000012317	PG-37BK	11 ml	crna			●		●									
000010046	PG-40BK	22 ml	crna		●	●	●	●									●
-	PG-50BK	22 ml	crna				●										●
000014276	PG-510BK	150 str.	crna								●						
000010164	PGI-5BK	26 ml	crna						●			●		●			
-	PGI-35BK	191 str.	crna	●													
000013841	PGI-520BK	19 ml	crna														
000016821	PGI-525BK	19 ml	crna							●				●			
000016822	CLI-526	9 ml	crna							●				●			
000016823	CLI-526	9 ml	plava							●				●			
000016824	CLI-526	9 ml	crvena							●				●			
000016825	CLI-526	9 ml	žuta							●				●			
000025583	PFI-306Y	330 ml	žuta														
000025581	PFI-306 M	330 ml	crvena														
000025568	PGI-35		crna														
000024651	PG-545XL	400 str.	crna														
000023351	CL-546	180 str.	color														
000023350	PG-545	180 str.	crna														
000022167	PGI-550BK XL	500 str.	crna														
000022166	CLI-551G	7 ml.	siva														
000021792	CLI-551Y XL	11 ml.	žuta														
000021790	CLI-551M XL	11 ml.	crvena														
000021789	CLI-551C XL	11 ml.	plava														
000021788	CLI-551BK XL	11 ml.	crna														
000021701	CL-541 XL	400 str.	color														
000021700	PG-540 XL	400 str.	crna														
000021553	CL-541	180 str.	color														
000021552	PG-540	180 str.	crna														
000021541	PGI-550BK	300 str.	crna														
000021540	CLI-551Y	7 ml.	žuta														
000021539	CLI-551M	7 ml.	crvena														
000021538	CLI-551C	7 ml.	plava														
000021537	CLI-551BK	7 ml.	crna														



MODEL
S 500/520/530/550/600/630/750/6300
S 800/5820/5830/5900/59000
Smartbase MP 360MP 370MP 390
Smartbase MP 700MP 730
Smartbase MPC 190/MPC 200
Smartbase MPC 400/600F
Fax B 100/110/120/140/150/155/1820/840
Fax B T18/725/730
Fax B 160/180/215
Fax IJ 200
Multipass 10/20
Multipass C20/C30/C50
Multipass C70/C75/C80
Multipass C100
Multipass 50, Fax B180C
Multipass C3/C2500, Fax MC 30
ImagePROGRAF IPF500/610/700/710/720
ImagePROGRAF W6200
ImagePROGRAF W6400

ŠIFRA	NAZIV	KAPACITET	BOJA	S 500/520/530/550/600/630/750/6300	S 800/5820/5830/5900/59000	Smartbase MP 360MP 370MP 390	Smartbase MP 700MP 730	Smartbase MPC 190/MPC 200	Smartbase MPC 400/600F	Fax B 100/110/120/140/150/155/1820/840	Fax B T18/725/730	Fax B 160/180/215	Fax IJ 200	Multipass 10/20	Multipass C20/C30/C50	Multipass C70/C75/C80	Multipass C100	Multipass 50, Fax B180C	Multipass C3/C2500, Fax MC 30	ImagePROGRAF IPF500/610/700/710/720	ImagePROGRAF W6200	ImagePROGRAF W6400	
000004240	BC-20BK	900 str.	crna																				
-	BC-21C	3500 str.	color																				
000002834	BCI-3BK	420 str.	crna	●			●		●									●		●			
000000170	BCI-3C	390 str.	plava	●			●		●									●					
000001492	BCI-3M	390 str.	crvena	●			●		●									●					
000003738	BCI-3Y	390 str.	žuta	●			●		●									●					
000000761	BCI-6BK	280 str.	crna		●																		
000000762	BCI-6C	280 str.	plava		●																		
000000765	BCI-6M	280 str.	crvena		●																		
000000763	BCI-6Y	280 str.	žuta		●																		
-	BCI-6PC	280 str.	plava		●																		
-	BCI-6PM	280 str.	crvena		●																		
000004004	BCI-21BK	140 str.	crna												●	●		●					
000005694	BCI-21E	100 str.													●	●		●					
000004006	BCI-21C	100 str.	color												●	●		●					
000007952	BCI-24BK	320 str.	crna			●		●															
000007953	BCI-24C	170 str.	color			●		●															
000014624	BCI-1431BK	130 ml	crna																		●	●	
000014609	BCI-1431M	130 ml	crvena																		●	●	
000014625	BCI-1431C	130 ml	plava																		●	●	
000014626	BCI-1431Y	130 ml	žuta																		●	●	
000014524	BCI-1431PM	130 ml	photo crvena																		●	●	
000014523	BCI-1431PC	130 ml	photo plava																		●	●	
000001712	BX-3BK	1000 str.	crna							●	●			●									
000006111	BX-20BK	1200 str.	crna									●				●							
000012318	CL-38C	3x3 ml	color																				
000010047	CL-41C	3x4 ml	color																				
000014123	CLI-8G	13 ml	zelena																				
000013842	CLI-521BK	9 ml	crna																				
000013843	CLI-521C	9 ml	plava																				
-	CLI-521G	9 ml	zelena																				
000013844	CLI-521M	9 ml	crvena																				
000013845	CLI-521Y	9 ml	žuta																				
000012201	PFI-102C	130 ml	plava																		●		
000012202	PFI-102M	130 ml	crvena																		●		
000012203	PFI-102Y	130 ml	žuta																		●		
000011941	PFI-102MBK	130 ml	matt crna																		●		
000012204	PFI-102PBK	130 ml	photo crna																		●		
000012317	PG-37BK	11 ml	crna																				
000010046	PG-40BK	22 ml	crna										●										
-	PG-50BK	22 ml	crna										●										

TONERI DELL



ŠIFRA	NAZIV	KAPACITET	BOJA	MODEL										
				Dell 1320c	Dell 1700/1700n	Dell 1720/1720n	Dell 2330dn	Dell 3110 cn	Dell 5110cn	Dell M 5200n	Dell M 5210	Dell S 250n		
000015753	PF028	5000 str.	crna					●						
000015756	RF012	4000 str.	plava					●						
000015754	MF790	4000 str.	crvena					●						
000015755	NF555	4000 str.	žuta					●						
-	PF030	8000 str.	crna					●						
-	PF029	8000 str.	plava					●						
-	RF013	8000 str.	crvena					●						
-	NF556	8000 str.	žuta					●						
000001236	R0136	12000 str.	crna								●			
-	R0137	18000 str.	crna								●			
000000963	2Y666	5000 str.	crna											●
-	2Y667	10000 str.	crna											●
000010647	J3815	3000 str.	crna		●									
000011234	K3756	6000 str.	crna		●									
-	D4283 BUBANJ	-	-		●									
-	MW558	6000 str.	crna			●								
000011884	PY408	3000 str.	crna			●								
-	TJ987 BUBANJ	-	-			●								
000017640	2330DN	2000 str.	crna				●							
000017641	2330DN	4000 str.	crna				●							
000017974	P237C	1000 str.	crna	●										
000017975	P238C	1000 str.	plava	●										
000017976	P240C	1000 str.	crvena	●										
000017977	P239C	1000 str.	žuta	●										
000017978	JD746	10000 str.	crna							●				
000017979	KD566	8000 str.	crvena							●				
000017980	GD908	8000 str.	žuta							●				
000017981	GD907	8000 str.	plava							●				
000017982	GD531	10000 str.	crna									●		
000018681	PK492	2000 str.	crna				●							

INK JET DELL



ŠIFRA	NAZIV	KAPACITET	BOJA	MODEL	
				926	V 305/505W
000022869	MK993		color	●	●
000022868	MK992		crna	●	●





MODEL

EPL N2550
EPL 5700/5800
EPL 5900/5900L
EPL 6200
AcuLaser C 900/1900
AcuLaser C1000
AcuLaser C1100
AcuLaser C 8500/8600
AcuLaser C 9100
AcuLaser CX-11/N/NF
AcuLaser M2000
AcuLaser M4000
AcuLaser M200/MX200/M200DN/M200DW/MX200DNF/MX200DWF

ŠIFRA	NAZIV	KAPACITET	BOJA	EPL N2550	EPL 5700/5800	EPL 5900/5900L	EPL 6200	AcuLaser C 900/1900	AcuLaser C1000	AcuLaser C1100	AcuLaser C 8500/8600	AcuLaser C 9100	AcuLaser CX-11/N/NF	AcuLaser M2000	AcuLaser M4000	AcuLaser M200/MX200/M200DN/M200DW/MX200DNF/MX200DWF
00005404	S050166	6000 str.	crna				●									
000007795	S050010	6000 str.	crna	●												
000009065	S050087	6000 str.	crna		●											
000009658	S050097	4500 str.	žuta					●								
000009659	S050098	4500 str.	crvena					●								
000009660	S050099	4500 str.	plava					●								
000009661	S050100	4500 str.	crna					●								
000009858	S050195	12000 str.	žuta									●				
000009859	S050198	15000 str.	crna									●				
000010080	S050196	12000 str.	crvena									●				
000010173	S050197	12000 str.	plava									●				
000013391	S050033	4000 str.	crna						●							
000013392	S050034	4000 str.	žuta						●							
000013393	S050035	4000 str.	crvena						●							
000013394	S050036	4000 str.	plava						●							
000014336	S050438	5000 str.	crna											●		
000014448	S050038	6000 str.	crna								●					
000014449	S050039	6000 str.	žuta								●					
000014484	S050040	6000 str.	crvena								●					
000014485	S050041	6000 str.	plava								●					
000015347	S051170	20000 str.	crna												●	
000015781	S050290	17000 str.	crna	●												
000021056	S050167	3000 str.	crna				●									
-	S050187	4000 str.	žuta							●			●			
-	S050188	4000 str.	crvena							●			●			
-	S050189	4000 str.	plava							●			●			
000010946	S050190	4000 str.	crna							●			●			
000010947	S050191	1500 str.	žuta							●			●			
000010948	S050192	1500 str.	crvena							●			●			
000010949	S050193	1500 str.	plava							●			●			
-	S051099 BUBANJ	20000 str.	-				●									
-	S051104 BUBANJ	42000 str.	-							●			●			
000023627	S050709	2500 str.	crna													●



ŠIFRA	NAZIV	KAPACITET	BOJA	MODEL															
				STYLUS C 20UX/ C 40UX	STYLUS C 41/42UX/44/46	STYLUS C 43/45	STYLUS C 60	STYLUS C 61/62	STYLUS C 64/66	STYLUS C 70/80/82	STYLUS C 84/86	STYLUS COLOR 400/440/460	STYLUS COLOR 480/580	STYLUS COLOR 600/640/660/670	STYLUS COLOR 680/685	STYLUS COLOR 700	STYLUS COLOR 740/760/800	STYLUS COLOR 820	STYLUS COLOR 850/860
000006163	T00301110	34 ml	crna																
000006165	T00501110	67 ml	color																
000005729	T00740110	16 ml	crna																
000005763	T00840110	46 ml	color																
000005730	T00940110	66 ml	color																
000006141	T01340110	10 ml	crna	●								●							
000006195	T01440110	25 ml	color	●								●							
000006168	T01740110	17 ml	crna										●						
000006160	T01840110	37 ml	color										●						
000006204	T01940110	24 ml	crna																●
000006205	T02040110	35 ml	color																●
000007934	T02640110	16 ml	crna														●		
000007935	T02740110	16 ml	color														●		
000006774	T02840110	17 ml	crna				●												
000006775	T02940110	37 ml	color				●												
000007715	T03414010	18 ml	crna																
000007770	T03424010	18 ml	plava																
000007852	T03434010	18 ml	crvena																
000007771	T03444010	18 ml	žuta																
000007853	T03454010	18 ml	žarko plava																
000007901	T03464010	18 ml	žarko crvena																
000007854	T03474010	18 ml	žarko crna																
000007902	T03484010	18 ml	matt crna																
000007709	T03614010	930 str.	crna	●															
000000385	T03704010	180 str.	color	●															
000005212	T03814A	330 str.	crna		●														
000005210	T03904A	180 str.	color		●														
000007717	T04014010	420 str.	crna					●											
000007718	T04104010	300 str.	color					●											
000007206	T03214010	16 ml	crna							●									
000007939	T04224010	16 ml	plava							●									
000008691	T04234010	16 ml	crvena							●									
000007938	T04244010	16 ml	žuta							●									
000001941	T04314010	29 ml	crna								●								
000004637	T04414010	13 ml	crna						●		●								
000018827	T04424010	13 ml	plava						●		●								
000018828	T04434010	13 ml	crna						●		●								
000018829	T04444010	13 ml	žuta						●		●								
000002743	T04524010	8 ml	plava						●		●								
000002745	T04534010	8 ml	crvena						●		●								
000007330	T04544010	8 ml	žuta						●		●								
000004168	T05014010	620 str.	crna								●	●		●					
000009043	T05114010	900 str.	crna												●			●	
000009044	T05204010	300 str.	color								●	●		●	●			●	



ŠIFRA	NAZIV	KAPACITET	BOJA	MODEL	STYLUS COLOR 900/980	STYLUS COLOR 925/935	STYLUS COLOR 1160/1520/2500	STYLUS COLOR CDP 2000	STYLUS COLOR EX	STYLUS CX 3200	STYLUS CX 3600/3650 MFP	STYLUS CX 5200/5400	STYLUS CX 6400/6600	STYLUS D 68/88	STYLUS D 78/92/120	STYLUS DX 3800/3850	STYLUS DX 4000/4050	STYLUS DX 4200/4250	STYLUS DX 4400/4450	STYLUS DX 4800/4850	STYLUS DX 5000/5550
					000006175	T00101110	66 ml	color													
000006163	T00301110	34 ml	crna		●																
000006165	T00501110	67 ml	color		●																
000005729	T00740110	16 ml	crna																		
000005763	T00840110	46 ml	color																		
000005730	T00940110	66 ml	color																		
000007934	T02640110	16 ml	crna			●															
000007935	T02740110	16 ml	color			●															
000006774	T02840110	17 ml	crna																		
000006775	T02940110	37 ml	color																		
000007207	T03224010	16 ml	plava									●									
000007208	T03234010	16 ml	crvena									●									
000007209	T03244010	16 ml	žuta									●									
000011915	T03314010	17 ml	crna																		
000011916	T03324010	17 ml	plava																		
000011917	T03334010	17 ml	crvena																		
000011918	T03344010	17 ml	žuta																		
000011919	T03354010	17 ml	svijetlo plava																		
000011920	T03364010	17 ml	svijetlo crvena																		
000007715	T03414010	18 ml	crna																		
000007770	T03424010	18 ml	plava																		
000007852	T03434010	18 ml	crvena																		
000007771	T03444010	18 ml	žuta																		
000007853	T03454010	18 ml	žarko plava																		
000007901	T03464010	18 ml	žarko crvena																		
000007854	T03474010	18 ml	žarko crna																		
000007902	T03484010	18 ml	matt crna																		
000007717	T04014010	420 str.	crna							●											
000007718	T04104010	300 str.	color							●											
000007206	T03214010	16 ml	crna									●									
000007939	T04224010	16 ml	plava									●									
000008691	T04234010	16 ml	crvena									●									
000007938	T04244010	16 ml	žuta									●									
000001941	T04314010	29 ml	crna										●								
000004637	T04414010	13 ml	crna								●		●								
000018827	T04424010	13 ml	plava								●		●								
000018828	T04434010	13 ml	crna								●		●								
000018829	T04444010	13 ml	žuta								●		●								
000002743	T04524010	8 ml	plava								●		●								
000002745	T04534010	8 ml	crvena								●		●								
000007330	T04544010	8 ml	žuta								●		●								
000000475	T04814010	13 ml	crna																		
000000478	T04824010	13 ml	plava																		



EPSON®				MODEL	STYLUS COLOR 900/980	STYLUS COLOR 925/935	STYLUS COLOR 1160/1520/2500	STYLUS COLOR CDP 2000	STYLUS COLOR EX	STYLUS CX 3200	STYLUS CX 3600/3650 MFP	STYLUS CX 5200/5400	STYLUS CX 6400/6600	STYLUS D 68/88	STYLUS D 78/92/120	STYLUS DX 3800/3850	STYLUS DX 4000/4050	STYLUS DX 4200/4250	STYLUS DX 4400/4450	STYLUS DX 4800/4850	STYLUS DX 5000/5550
ŠIFRA	NAZIV	KAPACITET	BOJA																		
00000481	T04834010	13 ml	crvena																		
00000483	T04844010	13 ml	žuta																		
00000487	T04854010	13 ml	svijetlo plava																		
00000491	T04864010	13 ml	svijetlo crvena																		
000004168	T05014010	620 str.	crna						•												
000009043	T05114010	900 str.	crna		•	•															
000009044	T05204010	300 str.	color		•	•	•														
-	T05304010	220 str.	color																		
-	T05414010	13 ml	photo crna																		
-	T05424010	13 ml	plava																		
-	T05434010	13 ml	crvena																		
-	T05444010	13 ml	žuta																		
000011090	T05514010	8 ml	crna																		
000011091	T05524010	8 ml	plava																		
000011092	T05534010	8 ml	crvena																		
000011093	T05544010	8 ml	žuta																		
000009925	T06114010	8 ml	crna										•		•		•			•	
000009964	T06124010	8 ml	plava										•		•		•			•	
000009965	T06134010	8 ml	crvena										•		•		•			•	
000009966	T06144010	8 ml	žuta										•		•		•			•	
000011139	T07114010	7,4 ml	crna											•		•		•			•
000011140	T07124010	5,5 ml	plava											•		•		•			•
000011141	T07134010	5,5 ml	crvena											•		•		•			•
000011142	T07144010	5,5 ml	žuta											•		•		•			•
000016597	T07914010	11 ml	crna																		
-	T07924010	11 ml	plava																		
-	T07934010	11 ml	crvena																		
000016598	T07944010	11 ml	žuta																		
000016599	T07954010	11 ml	svijetlo plava																		
000016600	T07964010	11 ml	svijetlo crvena																		
000011397	T08014010	7,4 ml	crna																		
000011398	T08024010	7,4 ml	plava																		
000011399	T08034010	7,4 ml	crvena																		
000011400	T08044010	7,4 ml	žuta																		
000011401	T08054010	7,4 ml	svijetlo plava																		
000011402	T08064010	7,4 ml	svijetlo crvena																		
000015769	T08914010	5,8 ml	crna																		
000016503	T08924010	3,5 ml	plava																		
000016403	T08934010	3,5 ml	crvena																		
000016504	T08944010	3,5 ml	žuta																		
-	T10014010	25,9 ml	crna																		
-	T10024010	11,1 ml	plava																		
-	T10034010	11,1 ml	crvena																		
-	T10044010	11,1 ml	žuta																		



MODEL

L100/L200/L300/L110/L210/L120/L335

L335/L300/L550/L110/L210 MEAFIS

L1300 ITS

SureColor 5C-T3000/5C-T5000/5C-T7000/5C-T7200

WorkForce M100/M105/M200

STYLUS Photo R2400

B-500DN/B-510DN

STYLUS Photo R2000

L800/L810/L850

L1800 ITS sprinter

XP-305/XP-402/XP-102/XP-202/XP-205/XP-405/
XP-302/XP-30/XP-215/XP-312/XP-315/XP-412/XP-415/
XP-212/XP-225/XP-322/XP-422/XP-325/XP-425/XP-405WH

WorkForce Pro WP-4015DN/WP-4525DNF/
WP-4095DN/WP-4595DNF/WP-4515DN

ŠIFRA	NAZIV	KAPACITET	BOJA	L100/L200/L300/L110/L210/L120/L335	L335/L300/L550/L110/L210 MEAFIS	L1300 ITS	SureColor 5C-T3000/5C-T5000/5C-T7000/5C-T7200	WorkForce M100/M105/M200	STYLUS Photo R2400	B-500DN/B-510DN	STYLUS Photo R2000	L800/L810/L850	L1800 ITS sprinter	XP-305/XP-402/XP-102/XP-202/XP-205/XP-405/ XP-302/XP-30/XP-215/XP-312/XP-315/XP-412/XP-415/ XP-212/XP-225/XP-322/XP-422/XP-325/XP-425/XP-405WH	WorkForce Pro WP-4015DN/WP-4525DNF/ WP-4095DN/WP-4595DNF/WP-4515DN
000024768	T6644	70 ml.	žuta	●	●	●									
000024767	T6643	70 ml.	crvena	●	●	●									
000024766	T6642	70 ml.	plava	●	●	●									
000024765	T6641	70 ml.	crna	●	●	●									
000024706	T6925	110 ml.	matt crna				●								
000024704	T7741	140 ml.	crna					●							
000024424	T6924	110 ml.	žuta				●								
000024423	T6923	110 ml.	crvena				●								
000024422	T6922	110 ml.	plava				●								
000024421	T6921	110 ml.	photo crna				●								
000024345	T0597	13 ml.	svijetlo crna						●						
000024343	T0595	13 ml.	svijetlo plava						●						
000024342	T0593	13 ml.	crvena						●						
000024341	T0592	13 ml.	plava						●						
000024313	T617400	7000 str.	žuta							●					
000024312	T617300	7000 str.	crvena							●					
000024311	T617200	7000 str.	plava							●					
000024310	T617100	4000 str.	crna							●					
000024087	C13T15904010	17 ml.	gloss optimizer								●				
000024086	C13T15994010	17 ml.	narančasta								●				
000024085	C13T15984010	17 ml.	matt crna								●				
000024084	C13T15974010	17 ml.	žarko crvena								●				
000024083	C13T15944010	17 ml.	žuta								●				
000024082	C13T15934010	17 ml.	crvena								●				
000024081	C13T15924010	17 ml.	plava								●				
000024080	C13T15914010	17 ml.	photo crna								●				
000023275	T6736	70 ml.	svijetlo crvena									●	●		
000023274	T6735	70 ml.	svijetlo plava									●	●		
000023273	T6734	70 ml.	žuta									●	●		
000023272	T6733	70 ml.	crvena									●	●		
000023271	T6732	70 ml.	plava									●	●		
000023270	T6731	70 ml.	crna									●	●		
000023233	T1804	180 str.	žuta											●	
000023232	T1803	180 str.	crvena											●	
000023231	T1802	180 str.	plava											●	
000023230	T1801	175 str.	crna											●	
000021573	T70144010 XXL	3400 str.	žuta												●
000021572	T70134010 XXL	3400 str.	crvena												●
000021571	T70124010 XXL	3400 str.	plava												●
000021570	T70114010 XXL	3400 str.	crna												●

EPSON®

ŠIFRA	NAZIV	KAPACITET	BOJA	MODEL				
				STYLUS PHOTO RX620/RX640	STYLUS PRO 4000PE/9600	STYLUS PRO 4400PE	STYLUS PRO 4800/4800PE	STYLUS PRO 7800/7880/9800/9880
00000475	T04814010	13 ml	crna	●				
00000478	T04824010	13 ml	plava	●				
00000481	T04834010	13 ml	crvena	●				
00000483	T04844010	13 ml	žuta	●				
00000487	T04854010	13 ml	svijetlo plava	●				
00000491	T04864010	13 ml	svijetlo crvena	●				
000020710	T544600	220 ml	svijetlo crvena		●			
000017687	T603100	220 ml	photo crna					●
000017603	T603200	220 ml	plava					●
000015811	T603300	220 ml	žarko crvena					●
000015813	T603400	220 ml	žuta					●
000016847	T603500	220 ml	svijetlo plava					●
000015812	T603600	220 ml	žarko svijetlo crvena					●
000017601	T603700	220 ml	svijetlo crna					●
000017602	T603900	220 ml	svijetlo crna					●
000021492	T603B00	220 ml	crvena					●
000021493	T603C00	220 ml	svijetlo crvena					●
000013109	T612800	220 ml	matt crna					●
000013689	T605100	110 ml	photo crna				●	
000013690	T605200	110 ml	plava				●	
000013691	T605300	110 ml	crvena				●	
000013692	T605400	110 ml	žuta				●	
000013693	T605500	110 ml	svijetlo plava				●	
000013694	T605600	110 ml	svijetlo crvena				●	
000014621	T605700	110 ml	svijetlo crna				●	
000013695	T605900	110 ml	svijetlo svijetlo crna				●	
000013703	T606700	220 ml	svijetlo crna				●	
000013696	T613800	110 ml	matt crna				●	
000014617	T614200	220 ml	plava			●		
000014618	T614300	220 ml	crvena			●		
000014619	T614400	220 ml	žuta			●		
000014620	T614800	220 ml	matt crna			●		





MODEL
HP LaserJet 4/4 + /4M/4M+ /5/5M/5N
HP LaserJet 4L/4ML/4P/4MP
HP LaserJet 5L/6L
HP LaserJet 5P/5MP/6P/6MP
HP LaserJet 55/55i MX/NX/Mopier 55i
HP LaserJet 1000w/1005w
HP LaserJet 1010/1012/1015/1018/1020/1022
HP LaserJet 1100/1100A
HP LaserJet 1150
HP LaserJet 1160
HP LaserJet 1200/1220
HP LaserJet 1300
HP LaserJet 1320
HP LaserJet 2100/MTN/ 2200
HP LaserJet 2300
HP LaserJet 2400/2410/2420/2430
HP LaserJet Pro M402, MFP M426
HP LaserJet Pro M203dw/dn, MFP M227fdw
HP LaserJet Pro MFP M26nw/a, M12w/a

ŠIFRA	NAZIV	KAPACITET	BOJA	HP LaserJet 4/4 + /4M/4M+ /5/5M/5N	HP LaserJet 4L/4ML/4P/4MP	HP LaserJet 5L/6L	HP LaserJet 5P/5MP/6P/6MP	HP LaserJet 55/55i MX/NX/Mopier 55i	HP LaserJet 1000w/1005w	HP LaserJet 1010/1012/1015/1018/1020/1022	HP LaserJet 1100/1100A	HP LaserJet 1150	HP LaserJet 1160	HP LaserJet 1200/1220	HP LaserJet 1300	HP LaserJet 1320	HP LaserJet 2100/MTN/ 2200	HP LaserJet 2300	HP LaserJet 2400/2410/2420/2430	HP LaserJet Pro M402, MFP M426	HP LaserJet Pro M203dw/dn, MFP M227fdw	HP LaserJet Pro MFP M26nw/a, M12w/a	
00001536	92274A	3350 str.	crna	●																			
00003575	92275A	3500 str.	crna																				
00000629	92298A	6800 str.	crna	●																			
00000629	92298X	8800 str.	crna	●																			
000001620	C3903A	4000 str.	crna				●																
000001636	C3906A	2500 str.	crna			●																	
000005018	C3909A	15000 str.	crna					●															
000004362	C4092A	2500 str.	crna								●												
000004830	C4096A	5000 str.	crna														●						
000004171	C4127A	6000 str.	crna																				
000007239	C4127X	10000 str.	crna																				
000004523	C4129X	10000 str.	crna																				
000007205	C4182X	20000 str.	crna																				
000006194	C7115A	2500 str.	crna					●						●									
000010176	C7115X	3500 str.	crna					●						●									
000002583	C8061A	6000 str.	crna																				
000007903	C8061X	10000 str.	crna																				
000009642	C8543X	30000 str.	crna																				
000012480	CB435A	1500 str.	crna																				
000012439	CB436A	2000 str.	crna																				
000013380	CC364A	10000 str.	crna																				
000014720	CE255A	6000 str.	crna																				
000015837	CE255X	12500 str.	crna																				
000013379	CE505A	2300 str.	crna																				
000027881	CF226A	3100 str.	crna																		●		
000000344	Q1338A	12000 str.	crna																				
000003493	Q1339A	18000 str.	crna																				
000000060	Q2610A	6000 str.	crna															●					
000000407	Q2612A	2000 str.	crna							●													
000000133	Q2613A	2500 str.	crna												●								
000010171	Q2613X	4000 str.	crna												●								
000000368	Q2624A	2500 str.	crna								●												
000000534	Q5942A	10000 str.	crna																				
000011297	Q5942X	20000 str.	crna																				
000009651	Q5945A	18000 str.	crna																				
000003214	Q5949A	2500 str.	crna										●			●							
000010177	Q5949X	6000 str.	crna													●							
000001628	Q6511A	6000 str.	crna																	●			
000001416	Q6511X	12000 str.	crna																	●			
000010440	Q7516A	12000 str.	crna																				
000011054	Q7551A	6500 str.	crna																				
000010871	Q7553A	3000 str.	crna																				
000030321	CF230A	1600 str.	crna																			●	
000031823	CF230X	3500 str.	crna																			●	
000030342	CF279A	1000 str.	crna																				●



MODEL

HP LaserJet P4015/P4510
HP Color LaserJet 1500
HP Color LaserJet 2500
HP Color LaserJet 4500/ND/4550
HP Color LaserJet 4600/4650
HP LaserJet Pro M203/MFP M227
HP Color LaserJet 5500/5550
HP Color LaserJet CM1312/MFP
HP Color LaserJet CP1215/CP1515/CP1518
HP Color LaserJet CP4005
HP Color LaserJet CM2320
HP LaserJet Pro M102/MFP M130/M104/M132/1130
HP Color LaserJet CP2020/CP2025
HP Color LaserJet Pro MFP M277/M252/M274
HP Color LaserJet Enterprise M552/553/577

ŠIFRA	NAZIV	KAPACITET	BOJA	HP LaserJet P4015/P4510	HP Color LaserJet 1500	HP Color LaserJet 2500	HP Color LaserJet 4500/ND/4550	HP Color LaserJet 4600/4650	HP LaserJet Pro M203/MFP M227	HP Color LaserJet 5500/5550	HP Color LaserJet CM1312/MFP	HP Color LaserJet CP1215/CP1515/CP1518	HP Color LaserJet CP4005	HP Color LaserJet CM2320	HP LaserJet Pro M102/MFP M130/M104/M132/1130	HP Color LaserJet CP2020/CP2025	HP Color LaserJet Pro MFP M277/M252/M274	HP Color LaserJet Enterprise M552/553/577
000000052	C4191A	9000 str.	crna				●											
000000065	C4192A	6000 str.	plava				●											
000000080	C4193A	6000 str.	crvena				●											
000000088	C4194A	6000 str.	žuta				●											
000005185	C4195A BUBANJ	25000/6250 str.	color				●											
000030994	CF360A		crna															●
000030995	CF361A		plava															●
000030996	CF362A		žuta															●
000030997	CF363A		crvena															●
000027293	CF400A	1500 str.	crna														●	
000027294	CF401A	1400 str.	plava														●	
000027295	CF402A	1400 str.	žuta														●	
000027296	CF403A	1400 str.	crvena														●	
000007941	C9700A	5000 str.	crna		●	●												
000007942	C9701A	4000 str.	plava		●	●												
000007943	C9702A	4000 str.	žuta		●	●												
000007944	C9703A	4000 str.	crvena		●	●												
000005401	C9704A BUBANJ	20000/5000 str.	color		●	●												
000008687	C9720A	9000 str.	crna					●										
000008688	C9721A	8000 str.	plava					●										
000008689	C9722A	8000 str.	žuta					●										
000008690	C9723A	8000 str.	crvena					●										
000007270	C9730A	13000 str.	crna							●								
000008854	C9731A	12000 str.	plava							●								
000008855	C9732A	12000 str.	žuta							●								
000008856	C9733A	12000 str.	crvena							●								
000012976	CB400A	7500 str.	crna										●					
000012977	CB401A	7500 str.	plava										●					
000012978	CB402A	7500 str.	žuta										●					
000012979	CB403A	7500 str.	crvena										●					
000012480	CB435A	1500 str.	crna															
000012439	CB436A	2000 str.	crna															
000012688	CB540A	2200 str.	crna								●	●						
000012689	CB541A	1400 str.	plava								●	●						
000012690	CB542A	1400 str.	žuta								●	●						
000012691	CB543A	1400 str.	crvena								●	●						
000013380	CC364A	10000 str.	crna	●														
000030507	CF219A BUBANJ	12000 str.	crna												●			
000031955	CF232A BUBANJ	23000 str.	crna						●									
000013142	CC531A	2800 str.	plava											●			●	
000013143	CC532A	2800 str.	žuta											●			●	
000013144	CC533A	2800 str.	crvena											●			●	



ŠIFRA	NAZIV	KAPACITET	BOJA	MODEL	HP LaserJet Pro 1566/1606/1606dn/1566	HP LaserJet M1130-M1139/M1212	HP Color LaserJet 1600	HP Color LaserJet 2550	HP Color LaserJet 2600/2605	HP Color LaserJet 2800/2820MFP/2840MFP	HP Color LaserJet 3500/3550	HP Color LaserJet 3600	HP Color LaserJet 3700	HP Color LaserJet 3800	HP Color LaserJet 4700	HP Color LaserJet CM1015MFP/CM1017MFP	HP Color LaserJet CM4730MFP	HP Color LaserJet CP3525	HP LaserJet Enterprise M606/M60/M604	HP LaserJet Enterprise M506/M501/MFP M527	
000014280	CE250A	5000 str.	crna																		
000014281	CE251A	7000 str.	plava																		
000014282	CE252A	7000 str.	žuta																		
000014283	CE253A	7000 str.	crvena																		
000016143	CE278A	2100 str.	crna		●																
000016008	CE285A	1600 str.	crna			●															
000027849	CF281A	10500 str.	crna																		●
000029054	CF287A	9000 str.	crna																		●
000003313	Q2670A	6000 str.	crna								●		●								
000004302	Q2671A	4000 str.	plava								●										
000003539	Q2672A	4000 str.	žuta								●										
000001290	Q2673A	4000 str.	crvena								●										
000009671	Q2681A	6000 str.	plava										●								
000009672	Q2682A	6000 str.	žuta										●								
000009673	Q2683A	6000 str.	crvena										●								
000000418	Q3960A	5000 str.	crna				●		●												
000000437	Q3961A	4000 str.	plava				●		●												
000000438	Q3962A	4000 str.	žuta				●		●												
000000496	Q3963A	4000 str.	crvena				●		●												
000001693	Q3964A BUBANJ	20000/5000 str.	color				●		●												
000010268	Q3971A	2000 str.	plava				●		●												
000010269	Q3972A	2000 str.	žuta				●		●												
000010270	Q3973A	2000 str.	crvena				●		●												
000010189	Q5950A	11000 str.	crna												●						
000010190	Q5951A	10000 str.	plava												●						
000010191	Q5952A	10000 str.	žuta												●						
000010192	Q5953A	10000 str.	crvena												●						
000002067	Q6000A	2500 str.	crna				●		●							●					
000002069	Q6001A	2000 str.	plava				●		●							●					
000002080	Q6002A	2000 str.	žuta				●		●							●					
000002099	Q6003A	2000 str.	crvena				●		●							●					
000016009	Q6460A	12000 str.	crna																●		
000016010	Q6461A	12000 str.	plava																●		
000016011	Q6462A	12000 str.	žuta																●		
000016841	Q6463A	12000 str.	crvena																●		
000010583	Q6470A	6000 str.	crna									●		●							
000010584	Q6471A	4000 str.	plava									●								●	
000010585	Q6472A	4000 str.	žuta									●								●	
000010586	Q6473A	4000 str.	crvena									●								●	

Make it matter.



**Otkrijte
krivotvoreni ispisni
uložak prije nego
bude prekasno**



MODEL

HP Deskjet 350C/350Cbi

HP Deskjet 400/400L/420C

HP Deskjet 460C

HP Deskjet 500/510/520

HP Deskjet 500C/540/550C/560C

HP Deskjet 600/660C/670C/680C

HP Deskjet 610C/615C/640C/656C

HP Deskjet 690C/695C

HP Deskjet 710C/720C/815C

HP Deskjet 810C

HP Deskjet 816/825C/840C/843C/845C

HP Deskjet 820Cxi/850C/870Cxi/1100C

HP Deskjet 820/850/870/1100

HP Deskjet 880C/890C/895Cxi/1120C/1125C

ŠIFRA	NAZIV	OZNAKA	KAPACITET	BOJA																
000001112	51626AE	26	40 ml/794 str.	crna		●		●	●											
000002389	51629A	29	650 str.	crna					●		●									
000004222	51640A	40	1122 str.	crna																
-	51640C	40	1600 str.	plava																
000001017	51640M	40	1122 str.	crvena																
-	51640Y	40	1122 str.	žuta																
000002744	51641A	41	461 str.	color															●	
000005114	51644C	44	-	plava																
000005115	51644M	44	-	crvena																
000005116	51644Y	44	-	žuta																
000001229	51645A	45	833 str.	crna										●				●		●
000000675	51649A	49	22,8 ml/310 str.	color					●	●	●									
000000833	C1806A	-	410 ml	crna																
000000837	C1807A	-	410 ml	plava																
000000836	C1808A	-	410 ml	crvena																
000000835	C1809A	-	410 ml	žuta																
000004281	C1823D	23	30 ml/690 str.	color										●	●					●
000009960	C4800A	10	12000 str.	crna																
000009961	C4801A	10	12000 str.	plava																
000009962	C4802A	10	12000 str.	crvena																
000009963	C4803A	10	12000 str.	žuta																
000009854	C4810A	11	16000 str.	crna																
000009855	C4811A	11	24000 str.	plava																
000028717	F6U65AE	302	165 str.	color																
000028736	F6U66AE	302	190 str.	crna																
000030315	F6U68AE	302XL	480 str.	crna																
000027962	F6V24AE	652	200 str.	color																
000027961	F6V25AE	652	360 str.	crna																
000002465	C4841A	10	28 ml/1650 str.	plava																
000002509	C4842A	10	28 ml/1650 str.	žuta																
000002510	C4843A	10	28 ml/1650 str.	crvena																
000002464	C4844A	10	69 ml/1430 str.	crna																



MODEL

HP Officejet 6700/6600/7612/7510A/7110

HP DeskWriter 520

HP DeskWriter 550C/560C

HP DeskWriter C

HP Officejet 125xi/135xi/145xi/155xi/7110/7130/7140

HP Officejet 500/590/635/700/710/725

HP Officejet 4110/425/5/5510

HP Officejet 4300/4315

HP Officejet 4355

HP Officejet 5110/ v40/v45

HP Officejet 5600/5605/5610/5615

HP Officejet 6110

HP Officejet 6210

HP DeskJet 3720/3730/2620/HP Envy 5030/5020

ŠIFRA	NAZIV	OZNAKA	KAPACITET	BOJA	HP Officejet 6700/6600/7612/7510A/7110	HP DeskWriter 520	HP DeskWriter 550C/560C	HP DeskWriter C	HP Officejet 125xi/135xi/145xi/155xi/7110/7130/7140	HP Officejet 500/590/635/700/710/725	HP Officejet 4110/425/5/5510	HP Officejet 4300/4315	HP Officejet 4355	HP Officejet 5110/ v40/v45	HP Officejet 5600/5605/5610/5615	HP Officejet 6110	HP Officejet 6210	HP DeskJet 3720/3730/2620/HP Envy 5030/5020
000001112	51626AE	26	40 ml/794 str.	crna		●	●	●										
000002389	51629A	29	650 str.	crna					●									
000001229	51645A	45	833 str.	crna														
000000675	51649A	49	22,8 ml/310 str.	color					●									
000004281	C1823D	23	30 ml/690 str.	color														
000009854	C4810A	11	16000 str.	crna														
000009855	C4811A	11	24000 str.	plava														
000009856	C4812A	11	24000 str.	crvena														
000009857	C4813A	11	24000 str.	žuta														
000007791	C4836AE	11	28 ml	plava														
000007792	C4837AE	11	28 ml	crvena														
000007793	C4838AE	11	28 ml	žuta														
000002464	C4844A	10	69 ml/1430 str.	crna														
000027195	CN057AE	932	400 str.	crna	●													
000015745	C4902AE	940	22 ml/1000 str.	crna														
000015746	C4907AE	940XL	16 ml/1400 str.	plava														
000015747	C4908AE	940XL	16 ml/1400 str.	crvena														
000015748	C4909AE	940XL	16 ml/1400 str.	žuta														
000012229	C4920AE	14	16000 str.	crna					●									
000012230	C4921AE	14	30000 str.	plava					●									
000012231	C4922AE	14	30000 str.	crvena					●									
000012232	C4923AE	14	30000 str.	žuta					●									
000003563	C5010DE	14	23 ml/470 str.	color					●									
000000371	C5011DE	14	26 ml/800 str.	crna					●									
000005663	C6578DE	78	450 str.	color										●				
000005127	C6614DE	20	450 str.	crna														
000005592	C6615DE	15	25 ml/495 str.	crna										●				
000007725	C6656AE	56	520 str.	crna						●					●	●		
000007726	C6657AE	57	500 str.	color						●						●		
000000358	C6658AE	58	500 str.	photo color											●	●		
000007313	C8727AE	27	10 ml	crna								●	●		●			
000007314	C8728AE	28	8 ml	color														
000000408	C8765EE	338	11 ml	crna													●	
000032056	N9K05AE	304	100 str.	color														●
000032055	N9K06AE	304	120 str.	crna														●



MODEL

HP Photosmart 1400/1401/1402/1410/1415/1417

HP Photosmart 2610/2710/8150/8450

HP Photosmart 3108/3110/3210/3310

HP Photosmart 6650

HP Photosmart 7150/7200/7350/7450/7550

HP Photosmart 7260/7660/7760/7900/7960

HP Photosmart 7850

HP Photosmart 8050/8150

HP Photosmart 8250

HP Photosmart C3180

HP Photosmart C4180/C4190

ŠIFRA	NAZIV	OZNAKA	KAPACITET	BOJA																
000004222	51640A	40	1122 str.	crna																
-	51640C	40	1600 str.	plava																
000001017	51640M	40	1122 str.	crvena																
-	51640Y	40	1122 str.	žuta																
000005114	51644C	44	-	plava																
000005115	51644M	44	-	crvena																
000005116	51644Y	44	-	žuta																
000000833	C1806A	-	410 ml	crna																
000000837	C1807A	-	410 ml	plava																
000000836	C1808A	-	410 ml	crvena																
000000835	C1809A	-	410 ml	žuta																
000009854	C4810A	11	16000 str.	crna																
000009855	C4811A	11	24000 str.	plava																
000009856	C4812A	11	24000 str.	crvena																
000009857	C4813A	11	24000 str.	žuta																
000007791	C4836AE	11	28 ml	plava																
000007792	C4837AE	11	28 ml	crvena																
000007793	C4838AE	11	28 ml	žuta																
000002464	C4844A	10	69 ml/1430 str.	crna																
000001766	C4846A	80	350 ml/4400 str.	plava																
000001769	C4847A	80	350 ml/4400 str.	crvena																
000001768	C4848A	80	350 ml/4400 str.	žuta																
000001761	C4871A	80	350 ml/4400 str.	crna																
000010025	C4872A	80	175ml/2200 str.	plava																
000010033	C4873A	80	175ml/2200 str.	žuta																
000010024	C4874A	80	175ml/2200 str.	crvena																
000002968	C4911A	82	69 ml/1750 str.	plava																
000002978	C4912A	82	69 ml/1750 str.	crvena																
000002983	C4913A	82	69 ml/1750 str.	žuta																
000012229	C4920AE	14	16000 str.	crna																
000012230	C4921AE	14	30000 str.	plava																
000012231	C4922AE	14	30000 str.	crvena																



ŠIFRA	NAZIV	OZNAKA	KAPACITET	BOJA	MODEL	HP Photosmart 1400/1401/1402/1410/1415/1417	HP Photosmart 2610/2710/8150/8450	HP Photosmart 3108/3110/3210/3310	HP Photosmart 6650	HP Photosmart 7150/7200/7350/7450/7550	HP Photosmart 7260/7660/7760/7900/7960	HP Photosmart 7850	HP Photosmart 8050/8150	HP Photosmart 8250	HP Photosmart C3180	HP Photosmart C4180/C4190
000012232	C4923AE	14	30000 str.	žuta												
000014706	C4930A	81	680 ml/1000 str.	crna												
000014707	C4931A	81	680 ml/1000 str.	plava												
000014708	C4932A	81	680 ml/1000 str.	crvena												
000014709	C4933A	81	680 ml/1000 str.	žuta												
-	C4934A	81	680 ml/1000 str.	svijetlo plava												
000014710	C4935A	81	680 ml/1000 str.	svijetlo crvena												
000011403	C4940A	83	680 ml	uv crna												
000011404	C4941A	83	680 ml	uv plava												
000011244	C4942A	83	680 ml	uv crvena												
000011245	C4943A	83	680 ml	uv žuta												
000011405	C4944A	83	680 ml	uv svijetlo plava												
000011644	C4945A	83	680 ml	uv svijetlo crvena												
000014711	C4990A 3/1	81	680 ml/1000 str.	crna												
000014712	C4994A 3/1	81	680 ml/1000 str.	plava												
000003563	C5010DE	14	23 ml/470 str.	color												
000000371	C5011DE	14	26 ml/800 str.	crna												
000010889	C5016A	84	69 ml/1750 str.	crna												
000014475	C5017A	84	69 ml	svijetlo plava												
000014476	C5018A	84	69 ml	svijetlo crvena												
000010434	C5058A	90	400 ml	crna												
000010435	C5060A	90	225 ml	plava												
000010436	C5062A	90	225 ml	crvena												
000010437	C5064A	90	225 ml	žuta												
000007725	C6656AE	56	520 str.	crna						●	●					
000007726	C6657AE	57	500 str.	color						●	●					
000000358	C6658AE	58	500 str.	photo color						●	●					
000011704	C8721EE	363	6 ml	crna			●							●		
000007313	C8727AE	27	10 ml	crna												
000007314	C8728AE	28	8 ml	color												
000000408	C8765EE	338	11 ml	crna		●					●				●	



MODEL

HP Photosmart 1400/1401/1402/1410/1415/1417

HP Photosmart 2610/2710/ 8150/8450

HP Photosmart 3108/3110/3210/3310

HP Photosmart 6650

HP Photosmart 7150/7200/7350/7450/7550

HP Photosmart 7260/7660/7760/7900/7960

HP Photosmart 7850

HP Photosmart 8050/8150

HP Photosmart 8250

HP Photosmart C3180

HP Photosmart C4180/C4190

ŠIFRA	NAZIV	OZNAKA	KAPACITET	BOJA	HP Photosmart 1400/1401/1402/1410/1415/1417	HP Photosmart 2610/2710/ 8150/8450	HP Photosmart 3108/3110/3210/3310	HP Photosmart 6650	HP Photosmart 7150/7200/7350/7450/7550	HP Photosmart 7260/7660/7760/7900/7960	HP Photosmart 7850	HP Photosmart 8050/8150	HP Photosmart 8250	HP Photosmart C3180	HP Photosmart C4180/C4190
00000838	C8766EE	343	7 ml	color		●					●	●		●	●
00000843	C8767EE	339	21 ml	crna	●			●				●			
000011912	C8771EE	363	4 ml/400 str.	plava			●						●		
000011705	C8772EE	363	3,5 ml/400 str.	crvena			●						●		
000011707	C8773EE	363	6 ml/400 str.	žuta			●						●		
000011699	C8774EE	363	5,5 ml/400 str.	svijetlo plava			●						●		
000011706	C8775EE	363	5,5 ml/400 str.	svijetlo crvena			●						●		
000001895	C9351AE	21	150 str.	crna	●										
000001901	C9352AE	22	138 str.	color	●										
00000878	C9359A	59	17 ml/110 str.	photo siva						●					
000010081	C9361EE	342	5 ml	color							●			●	●
000010082	C9362EE	336	5 ml	crna							●			●	
000000410	C9363EE	344	14 ml/450 str.	color		●		●				●			
000011136	C9364EE	337	11 ml	crna								●			●
000010645	C9369A	348	13 ml	photo color		●		●			●	●		●	●
000012981	C9370A	72	130 ml	photo crna											
000012982	C9371A	72	130 ml	plava											
000012983	C9372A	72	130 ml	crvena											
000012984	C9373A	72	130 ml	žuta											
000012985	C9374A	72	130 ml	siva											
000016244	C9397A	72	69 ml	photo crna											
000016241	C9398A	72	69 ml	plava											
000016243	C9399A	72	69 ml	crvena											
000016245	C9400A	72	69 ml	žuta											
000016242	C9401A	72	69 ml	siva											
000012986	C9403A	72	130 ml	matt black											
000010870	C9425A	85	28 ml	plava											
000010872	C9426A	85	28 ml	crvena											
000010816	C9427A	85	69 ml	žuta											
000010874	C9428A	85	69 ml	svijetlo plava											
000010876	C9429A	85	69 ml	svijetlo crvena											



MODEL
HP OfficeJet Pro 6950/6960/6970/6860/6978
HP OfficeJet 6100/7110/7510/7612/6700
HP Photosmart C4180/C4190
HP Photosmart C4280
HP Photosmart C5180/C6180/C6280/C7180/C7280
HP Photosmart C5280
HP Photosmart C5380/C6380
HP Photosmart D5160
HP Photosmart D5360
HP Photosmart D5460
HP DeskJet Ink Advantage 5575/HP OfficeJet 202 Mobile Printer/ HP OfficeJet 252

ŠIFRA	NAZIV	OZNAKA	KAPACITET	BOJA															
000013836	CB316EE	364	250 str.	crna															
000013837	CB317EE	364	250 str.	photo crna															
000013838	CB318EE	364	300 str.	plava															
000013839	CB319EE	364	300 str.	crvena															
000013840	CB320EE	364	300 str.	žuta															
000030117	LO570AE	953XL	2000 str.	crna															
000030114	F6U16AE	953XL	1600 str.	plava															
000030115	F6U17AE	953XL	1600 str.	crvena															
000030116	F6U18AE	953XL	1600 str.	žuta															
000030371	T6L99AE	903	300 str.	crna															
000030372	T6L87AE	903	315 str.	plava															
000030373	T6L91AE	903	315 str.	crvena															
000030374	T6L95AE	903	315 str.	žuta															
000011496	CB335EE	350	170 str.	crna															
000011622	CB336EE	350XL	850 str.	crna															
000011497	CB337EE	351	170 str.	color															
000011623	CB338EE	351XL	580 str.	color															
000025503	CN624AE	971	2500 str.	žuta															
000025502	CN623AE	971	2500 str.	crvena															
000025501	CN622AE	971	2500 str.	plava															
000025500	CN621AE	970	3000 str.	crna															
000024096	CZ132A	711		žuta															
000024095	CZ131A	711		crvena															
000024094	CZ130A	711		plava															
000023834	CN684	364XL	550 str.	crna															
000023091	CZ129A	711		crna															
000022062	CN056AE	933XL	800 str.	žuta															
000022061	CN055AE	933XL	800 str.	crvena															
000022060	CN054AE	933XL	800 str.	plava															
000022059	CN053AE	932XL	1000 str.	crna															
000021518	CZ102AE	650	200 str.	color															
000021517	CZ101AE	650	360 str.	crna															
000030436	C2P10AE	651	600 str.	crna															
000030437	C2P11AE	651	300 str.	color															



MODEL

ŠIFRA	NAZIV	KAPACITET	BOJA	FS 400/1400	FS 720/820/920	FS 1000/1010/1050	FS 1016MFP	FS 1018MFP	FS 1020/1118MFP	FS 1030D	FS 1100	FS 1116MFP	FS 1300D	FS 1700/1750	FS 1800	FS 1900	FS 1920	FS 2000D	FS 3700/3750	FS 3800
000006159	TK-11	1000 str.	crna	●																
000000577	TK-17	6000 str.	crna		●															
000014314	TK-18	7200 str.	crna				●	●												
000013574	TK-20H	20000 str.	crna											●					●	
-	TK-50H	15000 str.	crna												●					
000014816	TK-55	15000 str.	crna													●				
000009500	TK-60	20000 str.	crna												●					●
-	TK-65	20000 str.	crna																	
-	TK-70	40000 str.	crna																	
000011350	TK-100	6000 str.	crna																	
000012430	TK-110	6000 str.	crna		●		●					●								
000011197	TK-120	7200 str.	crna							●										
000016145	TK-130	7200 str.	crna										●							
000013322	TK-140	4000 str.	crna								●									
000015258	TK-310	12000 str.	crna																●	
000012172	TK-320	15000 str.	crna																	
000015498	TK-330	20000 str.	crna																	
-	TK-400	10000 str.	crna																	
000001783	TK-410	15000 str.	crna																	
000015250	TK-520K	6000 str.	crna																	
000015252	TK-520C	4000 str.	plava																	
000015251	TK-520M	4000 str.	crvena																	
000015253	TK-520Y	4000 str.	žuta																	
000012104	TK-710	40000 str.	crna																	
-	TK-825K	15000 str.	crna																	
-	TK-825C	7000 str.	plava																	
-	TK-825M	7000 str.	crvena																	
-	TK-825Y	7000 str.	žuta																	
000021671	TK-715	34000 str.	crna																	
000022365	TK-1110		crna																	
000025003	TK-1120	3000 str.	crna																	
000021515	TK-1140	7200 str.																		
000021906	TK-3130	25000 str.	crna																	
000024104	TK-340	12000 str.	crna																	
000021904	TK-350	15000 str.	crna																	
000022315	TK-435	15000 str.	crna																	
000024887	TK-560C	10000 str.	plava																	
000024888	TK-560K	12000 str.	crna																	
000024932	TK-560M	10000 str.	crvena																	
000024933	TK-560Y	10000 str.	žuta																	
000025471	TK-590C	5000 str.	plava																	
000025470	TK-590K	7000 str.	crna																	
000025472	TK-590M	5000 str.	crvena																	
000025473	TK-590Y	5000 str.	žuta																	
000025573	TK-630S	35000 str.	crna																	
000025570	TK-850SC	20000 str.	plava																	
000025569	TK-850SK	30000 str.	crna																	
000025571	TK-850SM	20000 str.	crvena																	
000025572	TK-850SY	20000 str.	žuta																	



MODEL

4080
C500
C510
C520
C540/544/546
C720
C780/782
C734/C736/C738
C792/792
C920
C935
E1.20/E1.20N
E232/E240/E240N
E250
E260/E360/E460
E330/E332/E340/E342N
E350/E352
OPTRA E210
OPTRA E220
OPTRA E310

ŠIFRA	NAZIV	KAPACITET	BOJA	4080	C500	C510	C520	C540/544/546	C720	C780/782	C734/C736/C738	C792/792	C920	C935	E1.20/E1.20N	E232/E240/E240N	E250	E260/E360/E460	E330/E332/E340/E342N	E350/E352	OPTRA E210	OPTRA E220	OPTRA E310
00000365	12A7460	5000 str.	crna																				
00000404	12S0400	2500 str.	crna																				•
00000558	12A5840	10000 str.	crna																				
00000733	24016SE	2500 str.	crna													•			•				
000001216	13T0301	3000 str.	crna																				
000001609	34016HE	6000 str.	crna																•				
000001699	12A6830	7500 str.	crna																				
000002205	18S0090	3200 str.	crna																				
000006947	13T0101	6000 str.	crna																				•
000007238	08A0476	3000 str.	crna																				
000007244	12A6860	10000 str.	crna																				
000007490	08A0478	6000 str.	crna																				
000009063	1382925	17600 str.	crna																				
000009509	15W0903	12000 str.	crna						•														
000009510	15W0900	7200 str.	plava						•														
000010255	10S0150	2000 str.	crna																			•	
000010604	64016SE	6000 str.	crna																				
000010835	W84020H	30000 str.	crna																				
000010873	12016SE	2000 str.	crna												•								
000011098	12A8420	6000 str.	crna																				
000011127	12A7400	3000 str.	crna																				
000011143	20K0503	5000 str.	crna			•																	
000011246	15W0902	7200 str.	žuta						•														
000011293	15W0901	7200 str.	crvena						•														
000011534	C5220KS	4000 str.	crna				•																
000011535	C5220CS	3000 str.	plava				•																
000011536	C5220MS	3000 str.	crvena				•																
000011537	C5220YS	3000 str.	žuta				•																
000012088	64016HE	21000 str.	crna																				
000012139	E250A11E	3500 str.	crna														•			•			
000012307	C9202CH	14000 str.	plava										•										
000012309	C9202YH	14000 str.	žuta										•										
000012310	C9202MH	14000 str.	crvena										•										
000012481	C9202KH	15000 str.	crna										•										
000012571	20K0500	3000 str.	plava			•																	
000012573	20K0501	3000 str.	crvena			•																	
000012574	20K0502	3000 str.	žuta			•																	
000012635	X340A11G	2500 str.	crna																				
000012989	X340H11G	6000 str.	crna																				
000012990	X340H22G BUBANJ	30000 str.	crna																				
000013567	17G0152	5000 str.	crna																				
000014439	E260A11E	3500 str.	crna															•					
000016084	X203A11G	2500 str.	crna																				



MODEL

4080
C500
C510
C520
C540/544/546
C720
C780/782
C734/C736/C738
C792/k792
C920
C935
E120/E120N
E232/E240/E240N
E250
E260/E360/E460
E330/E332N/E340/E342N
E350/E352
OPTRA E210
OPTRA E220

ŠIFRA	NAZIV	KAPACITET	BOJA	4080	C500	C510	C520	C540/544/546	C720	C780/782	C734/C736/C738	C792/k792	C920	C935	E120/E120N	E232/E240/E240N	E250	E260/E360/E460	E330/E332N/E340/E342N	E350/E352	OPTRA E210	OPTRA E220	
000016253	C734A1CG	6000 str.	plava								●												
000016254	C734A1KG	8000 str.	crna								●												
000016255	C734A1MG	6000 str.	crvena								●												
000016256	C734A1YG	6000 str.	žuta								●												
000016863	X264A11G	3500 str.	crna																				
000016864	X945X2CG	22000 str.	plava																				
000016865	X945X2KG	36000 str.	crna																				
000016866	X945X2MG	22000 str.	crvena																				
000016867	X945X2YG	22000 str.	žuta																				
000019935	C540A1CG	1000 str.	plava					●															
000019936	C540A1KG	1000 str.	crna					●															
000019937	C540A1MG	1000 str.	crvena					●															
000019938	C540A1YG	1000 str.	žuta					●															
000019939	C792A1KG	6000 str.	crna								●												
000020903	X860H21G	35000 str.	crna																				
000020906	X651H11E	25000 str.	crna																				
000021082	C780A1KG	6000 str.	crna							●													
000021083	C780A1MG	6000 str.	crvena							●													
000021084	C780A1YG	6000 str.	žuta							●													
000021081	C780A1CG	6000 str.	plava							●													
000021407	12A7460	5000 str.	crna																				
-	12A4710	6000 str.	crna																				
-	12A5845	25000 str.	crna																				
-	12A6835	20000 str.	crna																				
-	12A6865	30000 str.	crna																				
-	12A7405	6000 str.	crna																				
-	12A7410	5000 str.	crna	●																			
-	12A7415	10000 str.	crna	●																			
-	12A7612	21000 str.	crna																				
-	12A8302 BUBANJ	30000 str.	crna													●			●				
-	14K0050	12000 str.	crna																				
-	20K1400	6600 str.	plava			●																	
-	20K1401	6600 str.	crvena			●																	
-	20K1402	6600 str.	žuta			●																	
-	20K1403	10000 str.	crna			●																	
000019654	64416XE	32000 str.	crna																				
-	C500H2CG	3000 str.	plava		●																		
-	C500H2KG	5000 str.	crna		●																		
-	C500H2MG	3000 str.	crvena		●																		
000019653	X463H11G	9000 str.	crna																				



MODEL
CS310 / CS410 / CS510
CS310dn / CS310n / CS410dn / CS410dtn / CS410n
CS510
CS510de / CS510dte
CX310 / CX410 / CX510
CX310dn / CX310n
CX410 / CX510
CX410de / CX410dte / CX410e
CX510
CX510de / CX510dte / CX510dthe
M5310 / M5410 / M5510 / M5610
M5310d / M5310dn
M5410 / M5510 / M5610
M5410d / M5410dn
M5510 / M5610
M5510dn / M5610de / M5610dn / M5610dte
M5710 / M5711 / M5810 / M5811 / M5812
M5711 / M5811 / M5812

ŠIFRA	NAZIV	KAPACITET	BOJA	CS310 / CS410 / CS510	CS310dn / CS310n / CS410dn / CS410dtn / CS410n	CS510	CS510de / CS510dte	CX310 / CX410 / CX510	CX310dn / CX310n	CX410 / CX510	CX410de / CX410dte / CX410e	CX510	CX510de / CX510dte / CX510dthe	M5310 / M5410 / M5510 / M5610	M5310d / M5310dn	M5410 / M5510 / M5610	M5410d / M5410dn	M5510 / M5610	M5510dn / M5610de / M5610dn / M5610dte	M5710 / M5711 / M5810 / M5811 / M5812	M5711 / M5811 / M5812	
-	70C80C0	1000 str.	plava	●																		
-	70C80K0	1000 str.	crna	●																		
-	70C80M0	1000 str.	crvena	●																		
-	70C80Y0	1000 str.	žuta	●																		
-	70C8HC0	3000 str.	plava	●																		
-	70C8HK0	4000 str.	crna	●																		
-	70C8HM0	3000 str.	crvena	●																		
-	70C8HY0	3000 str.	žuta	●																		
-	80C80K0	1000 str.	crna	●																		
-	70C0H10	4000 str.	crna		●																	
-	70C0H20	3000 str.	plava		●																	
-	70C0H30	3000 str.	crvena		●																	
-	70C0H40	3000 str.	žuta		●																	
-	70C8XC0	4000 str.	plava			●																
-	70C8XK0	8000 str.	crna			●																
-	70C8XM0	4000 str.	crvena			●																
-	70C8XY0	4000 str.	žuta			●																
-	70C0X10	8000 str.	crna				●															
-	70C0X20	4000 str.	plava				●															
-	70C0X30	4000 str.	crvena				●															
-	70C0X40	4000 str.	žuta				●															
-	80C80C0	1000 str.	plava					●														
-	80C80M0	1000 str.	crvena					●														
-	80C80Y0	1000 str.	žuta					●														
-	80C8HC0	2000 str.	plava					●														
-	80C8HK0	2500 str.	crna					●														
-	80C8HM0	2000 str.	crvena					●														
-	80C8HY0	2000 str.	žuta					●														
-	80C0S10	2500 str.	crna						●													
-	80C0S20	2000 str.	plava						●													
-	80C0S30	2000 str.	crvena						●													
-	80C0S40	2000 str.	žuta						●													
-	80C8SC0	3000 str.	plava							●												
-	80C8SK0	4000 str.	crna							●												
-	80C8SM0	3000 str.	crvena							●												
-	80C8SY0	3000 str.	žuta							●												



MODEL

CX CS 417/317/517de	CX510	CX510de / CX510dhe / CX510dthe	M5310 / M5410 / M5510 / M5610	M5310d / M5310dn	M5410 / M5510 / M5610	M5410d / M5410dn	M5510 / M5610	M5510dn / M5610de / M5610dn / M5610dte	M5 MX 417/317/517de	M5810de / M5810dn / M5810dtn / M5810n	M5811dn / M5811dtn / M5811n / M5812de / M5812dn / M5812dtn	MX310 / MX410 / MX510 / MX511 / MX610 / MX611	MX310dn / MX410de	MX510 / MX511 / MX610 / MX611	MX510de / MX511dhe / MX511dhe / MX511dte / MX611dhe / MX611dhe	MX710 / MX711 / MX810 / MX811 / MX812	MX710de / MX710dhe	MX711 / MX810 / MX811 / MX812	MX711de / MX711dhe / MX810dhe / MX810dhe / MX810dhe / MX811dhe / MX811dhe / MX811dhe / MX812dhe / MX812dhe / MX812dhe / MX812dhe
---------------------	-------	--------------------------------	-------------------------------	------------------	-----------------------	------------------	---------------	--	---------------------	---------------------------------------	--	---	-------------------	-------------------------------	--	---------------------------------------	--------------------	-------------------------------	--

ŠIFRA	NAZIV	KAPACITET	BOJA																		
000031062	71B50K0	3000 str.	crna	●																	
000031065	71B50C0	2300 str.	plava	●																	
000031064	71B50M0	2300 str.	crvena	●																	
000031063	71B50Y0	2300 str.	žuta	●																	
-	80C8XC0	2300 str.	plava		●																
-	80C8XK0	8000 str.	crna		●																
-	80C8XM0	4000 str.	crvena		●																
-	80C8XY0	4000 str.	žuta		●																
-	80C0X10	8000 str.	crna			●															
-	80C0X20	4000 str.	plava			●															
-	80C0X30	4000 str.	crvena			●															
-	80C0X40	4000 str.	žuta			●															
-	50F5000	1500 str.	crna				●														
-	50F5H00	5000 str.	crna				●														
-	50F0HA0	5000 str.	crna					●													
-	50F5X00	10000 str.	crna						●												
-	50F0XA0	10000 str.	crna							●											
-	50F5U00	20000 str.	crna								●										
-	50F0UA0	20000 str.	crna									●									
000031090	51B5000	2500 str.	crna									●									
000031061	51B5H00	8500 str.	crna									●									
000032269	53B5000	11000 str.	crna									●									
-	52D0HA0	25000 str.	crna										●								
-	52D0XA0	45000 str.	crna											●							
-	60F5000	2500 str.	crna												●						
-	60F5H00	10000 str.	crna												●						
-	60F0HA0	10000 str.	crna													●					
-	60F5X00	20000 str.	crna														●				
-	60F0XA0	20000 str.	crna															●			
-	62D5000	6000 str.	crna																●		
-	62D5H00	25000 str.	crna																	●	
-	62D0HA0	25000 str.	crna																		●
-	62D5X00	45000 str.	crna																		●
-	62D0XA0	45000 str.	crna																		●



MODEL

ŠIFRA	NAZIV	KAPACITET	BOJA	MODEL	MX611de/MX5110de/MX410de/MX610de/MX510de/	MX611dhe/MX511dhe/	MX511dte/MX611dte/	MX611dfe	MS610de/	MS610dn/MS510dn/MS410dn/MS310dn/MS312dn/MS315dn/MS415dn	MS410/MS310/	MS610dn	MS610dfe	C5310/410/510	MS310/410/510/610,	CX410	CX310/410/510	C510	C552/524	C544/X544	C546/X546	C54x/X54x	
000022193	50FOZAO BUBANJ	60000 str.	crna		●	●	●	●	●	●	●	●	●										
000023731	50F5H00	5000 str.	crna												●								
000024774	70C80C0	1000 str.	plava											●									
000021962	70C8HCO	3000 str.	plava											●									
000024775	70C80K0	1000 str.	crna											●									
000021961	70C8HK0	4000 str.	crna											●									
000024776	70C80M0	1000 str.	crvena											●									
000021963	70C8HM0	4000 str.	crvena											●									
000024777	70C80Y0	1000 str.	žuta											●									
000021964	70C8HY0	3000 str.	žuta											●									
000023741	80C0H10	4000 str.	crna												●								
000023742	80C0H20	3000 str.	plava												●								
000023743	80C0H30	3000 str.	crvena												●								
000023744	80C0H40	3000 str.	žuta												●								
000023837	80C80C0	1000 str.	plava													●							
000021966	80C8HCO	3000 str.	plava													●							
000021965	80C8HK0	3000 str.	crna													●							
000021967	80C8HM0	3000 str.	crvena													●							
000021968	80C8HY0	3000 str.	žuta													●							
000023838	80C80K0	1000 str.	crna													●							
000024205	80C80M0	4000 str.	crvena													●							
000024773	80C85K0	2500 str.	crna													●							
000024206	80C80Y0	1000 str.	žuta													●							
000012571	20K0500	3000 str.	plava														●						
000012573	20K0501	3000 str.	crvena														●						
000012574	20K0502	3000 str.	žuta														●						
000011143	20K0503	5000 str.	crna														●						
000011535	C5220CS	3000 str.	plava															●					
000011534	C5220KS	4000 str.	crna																●				
000011536	C5220MS	3000 str.	crvena																●				
000011537	C5220YS	3000 str.	žuta																●				
000023703	C544X1CG	4000 str.	plava																	●			
000022687	C544X1KG	6000 str.	crna																	●			
000023701	C544X1MG	4000 str.	crvena																	●			
000023702	C544X1YG	4000 str.	žuta																	●			
000024168	C546U1KG	8000 str.	crna																		●		
000019935	C540A1CG	1000 str.	plava																			●	
000019936	C540A1KG	1000 str.	crna																			●	
000021929	50F5000	1500 str.	crna											●									
000018082	C540X75G	18000 str.																					●



Lexmark™

Success enabled

Powerful new Lexmark printers and MFPs are here!

Reliability. Security. Productivity.

The newest generation of mid-range monochrome printers and MFPs represent the latest chapter in Lexmark's heritage of developing the most technologically advanced and productive laser products on the market.

Lexmark's comprehensive approach to product security provides a full spectrum of security capabilities to protect the device, the network and the documents.



When it comes to productivity, powerful multi-core processors enable speedy performance and put the power of a departmental printer or MFP right on the desktop.

To learn more about what Lexmark printers and MFPs can do for you, visit www.lexmark.com today.



MODEL

ŠIFRA	NAZIV	KAPACITET	BOJA	C950	E350/352	E360/460	E450	E460	E935	M5710/711/810/811	MX310/410/510	MX710/810	T650/652/654	T650/652/654	T654	W850	X654/656/658	X850	X925
000021693	C950X2CG	22000 str.	plava	●															
000021053	C950X2KG	32000 str.	crna	●															
000021694	C950X2MG	22000 str.	crvena	●															
000021514	C950X2YG	22000 str.	žuta	●															
000021928	E352H11E	9000 str.	crna	●															
000021979	E360H11E	9000 str.	crna		●														
000022460	E450A11E	6000 str.	crna			●													
000021509	E460X11E	15000 str.	crna				●												
000018660	C930H2KG	38000 str.	crna					●											
000021929	50F5000	1500 str.	crna						●										
000024203	52D5000	6000 str.	crna							●									
000024546	52D5H00	25000 str.	crna							●									
000023204	60F5000	2500 str.	crna								●								
000022842	60F5H00	10000 str.	crna								●								
000023392	62D5000	6000 str.	crna									●							
000018717	12A7462	21000 str.	crna										●						
000020909	T650A11E	7000 str.	crna											●					
000018147	T650H11E	25000 str.	crna											●					
000021080	T654X11E	36000 str.	crna												●				
000021894	W850H21G	35000 str.	crna													●			
000021052	X654X11E	36000 str.	crna														●		
000021695	X850H21G	30000 str.	crna															●	
000018719	X925H2CG	7500 str.	plava																●
000018718	X925H2KG	8500 str.	crna																●
000018721	X925H2MG	7500 str.	crvena																●
000018720	X925H2YG	7500 str.	žuta																●
000020587	C925X72G - bubanj	30000 str.	crna																●
000020588	C925X73G - bubanj	30000 str.	plava																●
000020589	C925X74G - bubanj	30000 str.	crvena																●
000020590	C925X75G - bubanj	30000 str.	žuta																●
000020587	C925X72G - bubanj	30000 str.	crna																●
000020588	C925X73G - bubanj	30000 str.	plava																●
000020589	C925X74G - bubanj	30000 str.	crvena																●
000020590	C925X75G - bubanj	30000 str.	žuta																●
000021576	C925X76G - waste cont.	30000 str.																	●
000023568	C540X34G - developer	30000 str.	žuta																
000024204	52D0Z00 - imaging kit	60000 str.								●		●							
000023732	C540X74G - imaging kit	30000 str.		●															
000018082	C540X75G - waste cont.	18000 str.		●															
000021576	C925X76G - waste cont.	30000 str.			●														
000022459	25A0013 - municija	3x5000 kom				●													



MODEL

- Lexmark Color JetPrinter 11/3200
- Lexmark Impact S 305
- Lexmark Interact S 605
- Lexmark Interpret S 405
- Lexmark Intuition S 505
- Lexmark Jet Printer 5000/5700/7000/7200
- Lexmark P315, P450
- Lexmark P350
- Lexmark P700, P3100 Series
- Lexmark P910, P4000, P6000 Series
- Lexmark Platinum PRO 805
- Lexmark Prestige PRO 805
- Lexmark Preval PRO 805
- Lexmark Prospect PRO 205
- Lexmark PRO 901/905

ŠIFRA	NAZIV	OZNAKA	KAPACITET	BOJA	Lexmark Color JetPrinter 11/3200	Lexmark Impact S 305	Lexmark Interact S 605	Lexmark Interpret S 405	Lexmark Intuition S 505	Lexmark Jet Printer 5000/5700/7000/7200	Lexmark P315, P450	Lexmark P350	Lexmark P700, P3100 Series	Lexmark P910, P4000, P6000 Series	Lexmark Platinum PRO 805	Lexmark Prestige PRO 805	Lexmark Preval PRO 805	Lexmark Prospect PRO 205	Lexmark PRO 901/905
000001217	10NX217E	17	220 str.	crna															
000001234	10NX227E	27	229 str.	color															
000002542	17G0050E	50	410 str.	crna									●						
000002550	12AX970E	70	600 str.	crna															
000002965	12A1980E	80	275 str.	color	●				●										
000002991	12A1985E	85	470 str.	color	●				●										
000004676	10N0016E	16	410 str.	crna															
000004940	10N0026E	26	275 str.	color															
000005877	17G0060E	60	225 str.	color															
000007513	15MX120E	20	450 str.	color									●						
000009446	18L0032B	82	600 str.	crna															
000009447	18CX033E	33	190 str.	color						●			●						
000009871	18L0032E	82	600 str.	crna															
000009872	18LX042E	83	450 str.	color															
000010536	18C0031E	31	125 str.	photo color									●						
000010944	18CX781E	1	130 str.	crna + color															
000012932	18C1428E	28	175 str.	crna															
000012933	18C1429E	29	150 str.	color															
000013323	18C0034E	34XL	550 str.	crna									●						
000013938	18C2110E	15	150 str.	color															
000013939	18C2090E	14	175 str.	crna															
000014021	18C2080E	14A	175 str.	crna															
000014022	18C2100E	15A	150 str.	color															
000014613	18Y0141E	41	210 str.	color															
000014614	18C2140E	37	150 str.	color															
000014615	18C2130E	36	175 str.	crna															
000014616	18Y0142E	42	220 str.	crna															
000015140	18YX143E	43XL	500 str.	color								●							
000015141	18Y0144E	44	500 str.	crna															
000016423	14N0900	100	200 str.	plava		●	●	●	●					●	●	●	●		
000016424	14N0901	100	200 str.	crvena		●	●	●	●					●	●	●	●		
000016425	14N0902	100	200 str.	žuta		●	●	●	●					●	●	●	●		
000016862	14N0820	100	200 str.	crna		●	●	●	●					●	●	●	●		
000017020	14N1068	100XL	600 str.	crna		●	●	●	●					●	●	●	●	●	
000017021	14N1069	100XL	600 str.	plava		●	●	●	●					●	●	●	●	●	
000017022	14N1070	100XL	600 str.	crvena		●	●	●	●					●	●	●	●	●	
000017023	14N1071	100XL	600 str.	žuta		●	●	●	●					●	●	●	●	●	
000020685	14N0822	105XL	510 str.	crna										●	●	●	●	●	
-	18C0032E	32	363 str.	crna										●					
000020686	18C0035E	35	450 str.	color							●		●						



MODEL

Lexmark Z40 Series, Z51, Z52, Z53, Z54se
Lexmark Z55, Z65 Series
Lexmark Z705
Lexmark Z730 Series
Lexmark Z800 Series
Lexmark Z845
Lexmark Z1300 Series
Lexmark Z1400 Series
Lexmark Z1500 Series
Lexmark Z2320 Series
Lexmark Z2420 series
Lexmark Z111/31
Lexmark Z12/22/32
OfficeEdge Pro 4000/5500/5500t
Pro 400x/500x

ŠIFRA	NAZIV	OZNAKA	KAPACITET	BOJA	Lexmark Z40 Series, Z51, Z52, Z53, Z54se	Lexmark Z55, Z65 Series	Lexmark Z705	Lexmark Z730 Series	Lexmark Z800 Series	Lexmark Z845	Lexmark Z1300 Series	Lexmark Z1400 Series	Lexmark Z1500 Series	Lexmark Z2320 Series	Lexmark Z2420 series	Lexmark Z111/31	Lexmark Z12/22/32	OfficeEdge Pro 4000/5500/5500t	Pro 400x/500x
000001217	10NX217E	17	220 str.	crna															
000001234	10NX227E	27	229 str.	color															
000002542	17G0050E	50	410 str.	crna			•												
000002550	12AX970E	70	600 str.	crna	•														
000002965	12A1980E	80	275 str.	color												•			
000002991	12A1985E	85	470 str.	color												•			
000004676	10N0016E	16	410 str.	crna															
000004940	10N0026E	26	275 str.	color															
000005877	17G0060E	60	225 str.	color													•		
000007513	15MX120E	20	450 str.	color	•		•												
000009446	18L0032B	82	600 str.	crna		•													
000009447	18CX033E	33	190 str.	color					•										
000009871	18L0032E	82	600 str.	crna		•													
000009872	18LX042E	83	450 str.	color		•													
000010536	18C0031E	31	125 str.	photo color					•	•	•	•		•	•				
000010944	18CX781E	1	130 str.	crna + color				•											
000012932	18C1428E	28	175 str.	crna					•	•									
000012933	18C1429E	29	150 str.	color					•	•									
000013323	18C0034E	34XL	550 str.	crna					•	•	•	•							
000013938	18C2110E	15	150 str.	color										•					
000013939	18C2090E	14	175 str.	crna										•					
000014021	18C2080E	14A	175 str.	crna										•					
000014022	18C2100E	15A	150 str.	color										•					
000014613	018Y0141E	41	210 str.	color										•					
000014614	018C2140E	37	150 str.	color											•				
000014615	018C2130E	36	175 str.	crna											•				
000014616	18Y0142E	42	220 str.	crna										•					
000015140	18YX143E	43XL	500 str.	color										•					
000015141	18Y0144E	44	500 str.	crna										•					
000017021	14N1069	100XL	600 str.	plava															
000017022	14N1070	100XL	600 str.	crvena															
000017023	14N1071	100XL	600 str.	žuta															
000020685	14N0822	105XL	510 str.	crna															
-	18C0032E	32	363 str.	crna					•										
000020686	18C0035E	35	450 str.	color					•	•	•	•							
000021927	14L0200	200XLA	1600 str.	žuta														•	
000021926	14L0199	200XLA	1600 str.	crvena														•	
000021925	14L0198	200XLA	1600 str.	plava														•	
000021924	14L0197	200XLA	2500 str.	crna														•	
000024208	14L0173AB	220	650 str.	crna															•



MODEL

ŠIFRA	NAZIV	KAPACITET	BOJA	B 4000/4100/4200/4250	B 4300/4350	B 4400/4600	B 6200	B 6300	B 6500	B 8300	C 3100	C 3200	C 3300/3400	C 5100/5200/5300/5400	C 5250/5450/5510MFP/5540MFP	C 5600/5700	C 5800/5900	C 610
000011031	B4100 Type 9	2500 str.	crna	●	●													
000000759	B4200/4300 Type 9	2500 str.	crna	●	●													
000012222	B4400/4600	3000 str.	crna			●												
000014690	B4400/4600 BUBANJ	25000 str.	-			●												
-	B6200	10000 str.	crna				●											
-	B6300	17000 str.	crna					●										
000016144	B6500	13000 str.	crna						●									
-	B8300	27000 str.	crna							●								
-	C3100 Type C6L	3000 str.	žuta								●							
-	C3100 Type C6L	3000 str.	crvena								●							
-	C3100 Type C6L	3000 str.	plava								●							
-	C3100 Type C6L	3000 str.	crna								●							
-	C3200	1500 str.	žuta									●						
-	C3200	1500 str.	crvena									●						
-	C3200	1500 str.	plava									●						
-	C3200	1500 str.	crna									●						
-	C3200	3000 str.	žuta									●						
-	C3200	3000 str.	crvena									●						
-	C3200	3000 str.	plava									●						
-	C3200	3000 str.	crna									●						
000015367	C3300/3400	1500 str.	žuta										●					
000015366	C3300/3400	1500 str.	crvena										●					
000015365	C3300/3400	1500 str.	plava										●					
000015368	C3300/3400	1500 str.	crna										●					
-	C5100 Type C6	5000 str.	žuta											●				
-	C5100 Type C6	5000 str.	crvena											●				
-	C5100 Type C6	5000 str.	plava											●				
-	C5100 Type C6	5000 str.	crna											●				
-	C5100 BUBANJ	22000 str.	žuta											●				
-	C5100 BUBANJ	22000 str.	crvena											●				
-	C5100 BUBANJ	22000 str.	plava											●				
-	C5100 BUBANJ	22000 str.	crna											●				
-	C5250	3000 str.	žuta												●			
-	C5250	3000 str.	crvena												●			
-	C5250	3000 str.	plava												●			
-	C5250	3000 str.	crna												●			
-	C5250	5000 str.	žuta												●			
-	C5250	5000 str.	crvena												●			
-	C5250	5000 str.	plava												●			
-	C5250	5000 str.	crna												●			
-	C5600	2000 str.	žuta													●		
-	C5600	2000 str.	crvena													●		



MODEL

B 6300
B 6500
B 8300
C 3100
C 3200
C 3300/3400
C 5100/5200/5300/5400
C 5250/5450/5510MFP/5540MFP
C 5600/5700
C 5800/5900
C 610
C 7100/7300/7350/7500
C 9200/9400
C 9600/9800

ŠIFRA	NAZIV	KAPACITET	BOJA	B 6300	B 6500	B 8300	C 3100	C 3200	C 3300/3400	C 5100/5200/5300/5400	C 5250/5450/5510MFP/5540MFP	C 5600/5700	C 5800/5900	C 610	C 7100/7300/7350/7500	C 9200/9400	C 9600/9800
-	C5600	2000 str.	plava									●					
-	C5600	6000 str.	crna									●					
000013443	C5650/5750	2000 str.	plava									●					
000013444	C5650/5750	2000 str.	crvena									●					
000013445	C5650/5750	2000 str.	žuta									●					
000013446	C5650/5750	8000 str.	crna									●					
-	C5800/5900	5000 str.	žuta										●				
-	C5800/5900	5000 str.	crvena										●				
-	C5800/5900	5000 str.	plava										●				
-	C5800/5900	6000 str.	crna										●				
000015492	C610	6000 str.	žuta											●			
000015491	C610	6000 str.	crvena											●			
000015490	C610	6000 str.	plava											●			
000015349	C610	8000 str.	crna											●			
-	C7100 Type C4	10000 str.	žuta												●		
-	C7100 Type C4	10000 str.	crvena												●		
-	C7100 Type C4	10000 str.	plava												●		
-	C7100 Type C4	10000 str.	crna												●		
000005208	C9200/9400	15000 str.	žuta													●	
000013926	C9200/9400	15000 str.	crvena													●	
000005206	C9200/9400	15000 str.	plava													●	
000005386	C9200/9400	10000 str.	crna													●	
000013927	C9200/9400 BUBANJ	30000 str.	crvena													●	
-	C9600 Type C6	15000 str.	žuta														●
-	C9600 Type C6	15000 str.	crvena														●
-	C9600 Type C6	15000 str.	plava														●
-	C9600 Type C6	15000 str.	crna														●
-	OL 400/800	2500 str.	crna														
000001702	OL 400e Type 2	2000 str.	crna														
000003491	PAGE 4W	1200 str.	crna														
000005540	PAGE 6W/8W Type 6	1500 str.	crna														
000000732	PAGE 10i/12i Type 5	2500 str.	crna														
-	PAGE 14i Type 8	2000 str.	crna														
-	PAGE 14i Type 8 BUBANJ	20000 str.	crna														
000009045	PAGE 20n/24n Type 7	6000 str.	crna														
000021672	C9650	15000 str.	crna														
000021673	C9650	15000 str.	crvena														
000021675	C9650	15000 str.	plava														
000021674	C9650	15000 str.	žuta														



MODEL

KX-F 1000/1100
KX-FC 225/225AK/256/255AL/226
KX-FG 2451
KX-FL 401/402/403/411/412/413
KX-FL 501/551/755
KX-FL 511/512/513/540
KX-FL 611/613
KX-FLB 801/802/803/813/853
KX-FLB 851
KX-FLB 883
KX-FLM 653
KX-FM 200/205/250/260
KX-FP 81/85/151/155
KX-FP 141/145
KX-FP 205AL /215/205AL/215
KX-FP 343AL

ŠIFRA	NAZIV	KAPACITET	BOJA	KX-F 1000/1100	KX-FC 225/225AK/256/255AL/226	KX-FG 2451	KX-FL 401/402/403/411/412/413	KX-FL 501/551/755	KX-FL 511/512/513/540	KX-FL 611/613	KX-FLB 801/802/803/813/853	KX-FLB 851	KX-FLB 883	KX-FLM 653	KX-FM 200/205/250/260	KX-FP 81/85/151/155	KX-FP 141/145	KX-FP 205AL /215/205AL/215	KX-FP 343AL
000000004	FQ TF-15	5000 str.	crna																
000010791	KX-FA 52E 2/1	2X30 m	crna		●														●
000003811	KX-FA 54E	2X35 m	crna														●		
000006143	KX-FA 55A 2/1	300 str.	crna													●			
000000795	KX-FA 57E	210 str.	crna																●
000006709	KX-FA 76	3300 str.	crna				●												
-	KX-FA 77X BUBANJ	10000 str.	-				●												
000000448	KX-FA 78A BUBANJ	6000 str.	-				●												
000009004	KX-FA 83E	2500 str.	crna					●	●					●					
000002922	KX-FA 84 BUBANJ	10000 str.	-					●	●					●					
000012991	KX-FA 85E	5000 str.	crna								●		●						
000011287	KX-FA 86E BUBANJ	10000 str.	-			●					●	●							
000011311	KX-FA 87E	5000 str.	crna								●								
000003571	KX-FA 134 2/1	2X650 str.	crna	●															
000004578	KX-FA 136A 2/1	330 str.	crna												●				
000011346	KX-FAT 88E	2000 str.	crna				●												
000011347	KX-FAD 89E BUBANJ	10000 str.	-				●												
000012166	KX-FAT 92E	2000 str.	crna																
000013992	KX-FAT 92E-T 3/1	6000 str.	crna																
000012167	KX-FAD 93E BUBANJ	6000 str.	-																
000016111	KX-FAT 411E	2000 str.	crna																
000025870	KX-FAT420X	1500 str.	crna																
000027372	KX-FAT431X	6000 str.	crna																
000027234	KX-FAT472X	2000 str.	crna																
000005215	KX-P459	2000 str.	crna																
-	KX-PD P8	4000 str.	crna																
000002391	UG 3204	8000 str.	crna																
-	UG-3220 BUBANJ	20000 str.	-																
000012992	UG-3221	6000 str.	crna																
000002818	UG-3222	3000 str.	crna																
000003034	UG-3313	10000 str.	crna																
000005443	UG-3350	7500 str.	crna																
000030370	KX-FAD473X	10000 str.	crna																
000027745	KX-FA57E	240 str.	crna																



MODEL

ALFICIO 150/180
ALFICIO 1015/1018/1113
ALFICIO 1022/1027
ALFICIO 1035/1045
ALFICIO 2018/2020
ALFICIO 2035/2045
ALFICIO CL 7000/7100
ALFICIO COLOR 3006
ALFICIO AP 400/410
ALFICIO AP 3800C
FAX 1120L/1160L
FAX 1130/1170/2210L
FAX 1400L
FAX 3310L
FAX 4410L/4420L
FT 2012
FT 4015/4615
FT 4022/5131/5535
FX 200
GX 2500/3000/3050
GX 5050/7000
5250D
Aficio MP C2800/C3300/
Aficio MP C2500/C3000/C2000/

ŠIFRA	NAZIV	KAPACITET	BOJA	ALFICIO 150/180	ALFICIO 1015/1018/1113	ALFICIO 1022/1027	ALFICIO 1035/1045	ALFICIO 2018/2020	ALFICIO 2035/2045	ALFICIO CL 7000/7100	ALFICIO COLOR 3006	ALFICIO AP 400/410	ALFICIO AP 3800C	FAX 1120L/1160L	FAX 1130/1170/2210L	FAX 1400L	FAX 3310L	FAX 4410L/4420L	FT 2012	FT 4015/4615	FT 4022/5131/5535	FX 200	GX 2500/3000/3050	GX 5050/7000	5250D	Aficio MP C2800/C3300/	Aficio MP C2500/C3000/C2000/	
-	GC-21C	1000 str.	plava																					●	●			
-	GC-21K	1500 str.	crna																					●	●			
-	GC-21M	1000 str.	crvena																					●	●			
-	GC-21Y	1000 str.	žuta																					●	●			
-	TYPE 105BK	10000 str.	crna							●			●															
-	TYPE 105C	10000 str.	plava							●			●															
-	TYPE 105M	10000 str.	crvena							●			●															
-	TYPE 105Y	10000 str.	žuta							●			●															
000000229	TYPE 185	12000 str.	crna	●																								
-	TYPE 205	20000 str.	crna							●			●															
-	TYPE 220	15000 str.	crna									●																
000010875	TYPE 450E	2X7500 str.	crna																			●						
000007281	TYPE 1205	6000 str.	crna																			●						
000011285	TYPE 1220D	9000 str.	crna	●																								
000013631	TYPE 1230D	9000 str.	crna					●																				
-	TYPE 1240D	4800 str.	crna														●											
-	TYPE 1260D	5000 str.	crna															●	●									
-	TYPE 1265D	6000 str.	crna											●														
000011052	TYPE 1275D	3500 str.	crna												●													
000008957	TYPE 2200	3000 str.	crna																			●						
000001904	TYPE 2220D	11000 str.	crna		●																							
000011427	TYPE 2285	5000 str.	crna																				●					
000011170	TYPE 3205D	23000 str.	crna				●																					
000011247	TYPE 3210D	30000 str.	crna						●																			
000011229	TYPE K1-B	9600 str.	crna									●																
000011232	TYPE K1-C	9600 str.	plava									●																
000011230	TYPE K1-M	9600 str.	crvena									●																
000011231	TYPE K1-Y	9600 str.	žuta									●																
000025011	885048	42000 str.	crna																							●		
000021865	841124		crna																								●	
000021866	841125		žuta																								●	
000021867	841127		plava																								●	
000022818	841426		crvena																								●	
000025009	842030	2000 str.	crna																									●
000025010	842033	1500 str.	plava																									●



ŠIFRA	NAZIV	KAPACITET	BOJA	MODEL															
				CLP 300	CLP 310/315	CLP 500/500N/550/550N	CLX 2160/3160	ML-848S/85G/86	ML 1010/1020	ML 1210/1220/1250	ML 1410	ML 1430	ML 1440/1450/1451	ML 1510/1710/1750	ML 1520	ML 1610	ML 1630	ML 1640/2240	ML 1660
00000413	ML-2150D8	8000	crna																
00000495	ML-1520D3	3000	crna																
00000567	CLP-500D5C	5000	plava			●													
00000571	CLP-500D5M	5000	crvena			●													
00000572	CLP-500D5Y	5000	žuta			●													
00000768	CLP-500D7K	7000	crna			●													
00000875	ML-6060D6	6000	crna																
000001894	ML-C810	5000	crna																
000005087	ML-1710D3	3000	crna																
000008033	SCX-4216D3	3000	crna																
000009064	ML-1210D3	3000	crna																
000009692	ML-4500D3	2500	crna																
000009947	ML-1610D2	2000	crna																
000010355	SF-5100D3	3000	crna																
000010409	SCX-4521D3	3000	crna																
000011053	ML-2010D3	3000	crna																
000011116	SCX-D4200A	3000	crna																
000011701	CLP-C600A	4000	plava																
000011702	CLP-M600A	4000	crvena																
000011703	CLP-Y600A	4000	žuta																
000011708	CLP-B600A	4000	crna																
000011321	ML-2250D5	5000	crna																
000011881	ML-2550DA	10000	crna																
000012069	ML-D3050A	4000	crna																
000012168	CLP-K300A	2000	crna	●			●												
000012169	CLP-M300A	1000	crvena	●			●												
000012170	CLP-C300A	1000	plava	●			●												
000012171	CLP-Y300A	1000	žuta	●			●												
000012372	SCX-4100D3	3000	crna																
000013419	ML-D2850B	5000	crna																
000013684	MLT-D1082S	1500	crna																
000013964	CLP-500RB OPC BUBANJ	50000	-			●													
000013989	MLT-D1092S	2000	crna																
000015501	CLT-K4092S	1500	crna		●														
000015503	CLT-C4092S	1000	plava		●														
000015504	CLT-Y4092S	1000	žuta		●														
000015506	CLT-M4092S	1000	crvena		●														
000015775	MLT-D1052S	1500	crna																
000015971	MLT-D2092S	2000	crna																
000016427	MLT-D1042S	1500	crna																
-	ML-D1630A	2000	crna																
000018702	MLT-D2092L	5000	crna																
-	SCX-4720D3	3000	crna																
-	SCX-5312D6	6000	crna																
-	SCX-5530B	8000	crna																



ŠIFRA	NAZIV	KAPACITET	BOJA	MODEL	CLP 300	CLP 310/315	CLP 500/500N/550/550N	CLX 2160/3160	ML-84/85/85G/86	ML 1010/1020	ML 1210/1220/1250	ML 1410	ML 1430	ML 1440/1450/1451	ML 1510/1710/1750	ML 1520	ML 1610	ML 1630	ML 1640/2240	ML 1660	ML 1710/1740/1750	ML 2010/2510	ML 2150/2151/2152	
000025266	CLP-C660A	2000 str.	plava																					
000025265	CLP-K660A	2500 str.	crna																					
000025267	CLP-M660A	2500 str.	crvena																					
000025268	CLP-Y660A	2000 str.	žuta																					
000022987	CLT-C406S	1000 str.	plava																					
000021864	CLT-K406S	1000 str.	crna																					
000022985	CLT-M406S	1000 str.	crvena																					
000024895	CLT-M504S	1800 str.	crvena																					
000022986	CLT-Y406S	1000 str.	žuta																					
000023279	ML-D2850A	2000 str.	crna																					
000023723	MLT-D111S	1000 str.	crna																					
000023250	MLT-D116S	1200 str.	crna																					
000021533	MLT-D117S	2500 str.	crna																					
000022366	MLT-D119S	2000 str.	crna																					
000022846	MLT-D205S	2000 str.	crna																					
000024698	SCX-D6555A	25000 str.	crna																					
000024699	SCX-R6555A	80000 str.	crna																					
000024695	CLT-R409	24000 str.	crna																					
000023745	MLT-R116	9000 str.	crna																					



xerox



MODEL

ŠIFRA	NAZIV	KAPACITET	BOJA	2510/2511	3050/3040/3050/3060	5337/5340/5350/5665/5837/5845/5855	5616/5621/5815	5915/5918/5921	Copy Centre C118	Document Centre 220D/230/420/430	Document Centre 332/340/425/440	Document Centre 535/545/555	Dokuprint 4517/N17	Dokuprint P 1202	Dokuprint P 1210	Dokuprint P BejP 8ex	Phaser 2515/2520/2950	Phaser 3100 MFP	Phaser 3116
000009650	006R00910	9000 str.	crna																
000009649	006R00916/917	3000 str.	crna																
000010580	006R01020	6000 str.	crna					●											
000011423	006R01046	2X30000 str.	crna									●							
000011003	006R01179	11000 str.	crna						●										
000011117	006R01182	30000 str.	crna																
000013364	006R01278	8000 str.	crna																
000011327	006R90129/006R00234	2000 str.	crna	●															
000000752	006R90166	3000 str.	crna														●		
000005213	006R90203	24000 str.	crna			●													
000003911	006R90246	5500 str.	crna				●												
000002249	006R90269	15000 str.	crna		●														
000009616	006R90270/006R90246	5500 str.	crna				●												
000013363	013R00606	5000 str.	crna																
000015254	013R00607	3500 str.	crna																
000011351	013R00621	3000 str.	crna																
000014521	013R00623 BUBANJ	55000 str.	-																
000015856	013R00625	3000 str.	crna																
000014459	101R00432 BUBANJ	23000 str.	-																
000003049	106R00398	6000 str.	crna											●					
000013317	106R00442	6000 str.	crna												●				
000010581	106R00443	2X5000 str.	crna																
000001000	106R00462	8000 str.	crna																
000000396	106R00586	6000 str.	crna																
000010406	106R00587	2X7500 str.	crna																
000008038	106R01044	12000 str.	crna																
000029773	106R02773	1500 str.	crna																
000014005	106R01077	18000 str.	plava																
000014006	106R01078	18000 str.	crvena																
000014007	106R01079	18000 str.	žuta																
000014008	106R01080	18000 str.	crna																
000013866	106R01148	6000 str.	crna																
000028117	106R02778	3000 str.	crna																
000012366	106R01159	3000 str.	crna																
000033217	106R03395	15500 str.	crna																



MODEL

2510/2511

3050/3040/3050/3060

5337/5340/5350/5665/5837/5845/5855

5616/5621/5815

5915/5918/5921

Copy Centre C118

Document Centre 2200/230/420/430

Document Centre 332/340/425/440

Document Centre 535/545/555

Dokuprint 4517/N17

Dokuprint P 1202

Dokuprint P 1210

Dokuprint P 8e/P 8ex

Phaser 2515/2520/2950

Phaser 3100 MFP

Phaser 3116

ŠIFRA	NAZIV	KAPACITET	BOJA	2510/2511	3050/3040/3050/3060	5337/5340/5350/5665/5837/5845/5855	5616/5621/5815	5915/5918/5921	Copy Centre C118	Document Centre 2200/230/420/430	Document Centre 332/340/425/440	Document Centre 535/545/555	Dokuprint 4517/N17	Dokuprint P 1202	Dokuprint P 1210	Dokuprint P 8e/P 8ex	Phaser 2515/2520/2950	Phaser 3100 MFP	Phaser 3116	
000016191	106R01204/1273	1000 str.	žuta																	
000016192	106R01205/1272	1000 str.	crvena																	
000016193	106R01206/1271	1000 str.	plava																	
000014458	106R01277	25000 str.	crna																	
000015249	106R01373	3500 str.	crna																	
000014340	106R01374	5000 str.	crna																	
000014339	106R01378	2200 str.	crna																	●
000018107	106R01379	4000 str.	crna																	●
000016248	108R00908	1500 str.	crna																	
000011546	109R00725	3000 str.	crna																	
000011422	109R00746	3500 str.	crna																	
-	109R00747	5000 str.	crna																	
-	109R00748	3000 str.	crna																	●
000000394	113R00095	10000 str.	crna										●							
000000858	113R00276/13R90130	20000 str.	crna							●										
000000218	113R00296	5000 str.	crna													●				
000003457	113R00307	23000 str.	crna								●									
000013096	113R00667	3500 str.	crna																	
-	113R00671 BUBANJ	20000 str.	-																	
000013098	113R00730	3000 str.	crna																	
000024078	006R01160	30000 str.	crna																	
000022364	106R01305	30000 str.	crna																	
000023223	106R01487	4100 str.	crna																	
000024554	106R01573	24000 str.	crna																	
000024555	106R01624	6000 str.	plava																	
000024556	106R01625	6000 str.	žuta																	
000024557	106R01626	6000 str.	crvena																	
000024331	113R318	23000 str.	crna																	
000021875	113R00737	10000 str.	crna																	
000024429	106R01631	1000 str.	plava																	
000024430	106R01632	1000 str.	crvena																	
000024431	106R01633	1000 str.	žuta																	
000024648	106R01443	17800 str.	plava																	
000024647	106R01444	17800 str.	crvena																	
000024147	106R01445	17800 str.	žuta																	
000024148	106R01446	19800 str.	crna																	
000021465	106R02182	2200 str.	crna																	
000023796	106R02310	5000 str.	crna																	
000021869	106R01531	11000 str.	crna																	



ZA BROTHER PRINTERE

ŠIFRA	NAZIV	KAPACITET	BOJA	HL 1030	HL 1230/1240/1250/1270N	HL 1430/1440/1450/1470N/12500	HL 1650/1670N/1750/1850/1870N	HL 2030/2040/2070	HL 5100 SERIJA	HL 5130/5140/5150D/5170DN/DCP8040	DCP 7010/7420/7820	MFC 8220/8440/8840	MFC 8420/8820	MFC 9160	MFC 9650/9660/9750	MFC 9850/9860/9870/9880	FAX 2920	FAX 8350P/8360P/8750P
000013226	TN 2000	2500 str.	crna					•			•							•
000013228	TN 3030	3500 str.	crna						•	•		•						
000013227	TN 6300	3000 str.	crna	•	•	•									•	•		•
000013864	TN 6600	6000 str.	crna	•	•	•									•	•		•
000013229	TN 7300	3300 str.	crna				•					•						
000013865	TN 8000	2200 str.	crna										•					



ZA CANON PRINTERE

ŠIFRA	NAZIV	KAPACITET	BOJA	LBP 800/810/1120	LBP 3200	LBP 3310/3370	MF 3110/3220/3240	MF 4010/4120/4140/4150	MF 4510/4330/4340/4350/4370/4380	MF 4660/4690	MF 5530/5550	MF 5630/5650	MF 5730/5750/5770	L60/L90	Fax L100/L120	Fax L200/L220/L240/L250	Fax L260/L280/L290/L295	Fax L300/L350/L360	FC 100/120	FC 200/204/210/220/224/230	FC 310/330/336/530	IR 1018/1020/1022	
000013766	C-EXV 3	15000 str.	crna																				
000013764	C-EXV 5	2x7850 str.	crna																				
000013765	C-EXV 6	6900 str.	crna																				
000013763	C-EXV 7	5300 str.	crna																				
000013790	C-EXV 11	21000 str.	crna																				
000013761	C-EXV 14	8300 str.	crna																				
000013762	C-EXV 18	8400 str.	crna																				•
000013863	E30	3000 str.	crna																•	•	•		
000013861	EP-22	2500 str.	crna	•																			
000013862	EP-27	2500 str.	crna		•		•				•	•	•										
000012555	FX-3	4500 str.	crna											•		•	•	•					
000012556	FX-10	2000 str.	crna					•	•	•					•								
000016595	CRG-715H	2000 str.	crna			•																	
000033446	C-EXV 3	15000 str.	crna																				
000029137	CEXV 40	6000 str.	crna																				
000029138	CRG-719H	6400 str.	crna																				



ZA HP PRINTERE

HP LaserJet 1000w/1005w
HP LaserJet 1010/1012/1015/1018/1020/1022
HP LaserJet 1100/1100A
HP LaserJet 1160
HP LaserJet 1200/1220
HP LaserJet 1320
HP LaserJet 1300/1300n/1300xi
HP LaserJet 2100/MTN/ 2200
HP LaserJet 2300
HP LaserJet 2400/2410/2420/2430
HP LaserJet 3015/3020MFP/3030MFP
HP LaserJet 3050MFP/3052MFP/3055MFP
HP LaserJet 3200
HP LaserJet 3300MFP/ 3320/ 3330MFP/ 3380MFP
HP LaserJet 3390MFP/3392MFP
HP LaserJet 4000/ITN/ITN/ 4050
HP LaserJet 4200
HP LaserJet 4250/ 4350
HP LaserJet M1005MFP

ŠIFRA	NAZIV	KAPACITET	BOJA	HP LaserJet 1000w/1005w	HP LaserJet 1010/1012/1015/1018/1020/1022	HP LaserJet 1100/1100A	HP LaserJet 1160	HP LaserJet 1200/1220	HP LaserJet 1320	HP LaserJet 1300/1300n/1300xi	HP LaserJet 2100/MTN/ 2200	HP LaserJet 2300	HP LaserJet 2400/2410/2420/2430	HP LaserJet 3015/3020MFP/3030MFP	HP LaserJet 3050MFP/3052MFP/3055MFP	HP LaserJet 3200	HP LaserJet 3300MFP/ 3320/ 3330MFP/ 3380MFP	HP LaserJet 3390MFP/3392MFP	HP LaserJet 4000/ITN/ITN/ 4050	HP LaserJet 4200	HP LaserJet 4250/ 4350	HP LaserJet M1005MFP	
000014657	C9730A	13000 str.	crna																				
000014658	C9731A	12000 str.	plava																				
000014659	C9732A	12000 str.	žuta																				
000014660	C9733A	12000 str.	crvena																				
000013216	CB435A	1500 str.	crna																				
000013217	CB436A	2000 str.	crna																				
000014661	CB540A	2200 str.	crna																				
000014662	CB541A	1400 str.	plava																				
000014663	CB542A	1400 str.	žuta																				
000014664	CB543A	1400 str.	crvena																				
000014665	CC530A	3500 str.	crna																				
000014666	CC531A	2800 str.	plava																				
000014667	CC532A	2800 str.	žuta																				
000014668	CC533A	2800 str.	crvena																				
000014807	CE505A	2300 str.	crna																				
000013256	Q1338A	12000 str.	crna																		•		
000013329	Q2610A	6000 str.	crna									•											
000012550	Q2612A	2000 str.	crna	•										•	•								•
000012551	Q2613A	2000 str.	crna							•													
000014642	Q2670A	6000 str.	crna																				
000014643	Q2671A	4000 str.	plava																				
000014644	Q2672A	4000 str.	žuta																				
000014645	Q2673A	4000 str.	crvena																				
000014638	Q3960A	5000 str.	crna																				
000014639	Q3961A	4000 str.	plava																				
000014640	Q3962A	4000 str.	žuta																				
000014641	Q3963A	4000 str.	crvena																				
000013257	Q5942A	10000 str.	crna																			•	
000012553	Q5949A	2500 str.	crna				•		•									•					
000014630	Q6000A	2500 str.	crna																				
000014631	Q6001A	2000 str.	plava																				
000014632	Q6002A	2000 str.	žuta																				
000014633	Q6003A	2000 str.	crvena																				
000014646	Q6470A	6000 str.	crna																				



ZA HP PRINTERE

HP LaserJet 1000w/1005w
HP LaserJet 1010/1012/1015/1018/1020/1022
HP LaserJet 1100/1100A
HP LaserJet 1160
HP LaserJet 1200/1220
HP LaserJet 1320
HP LaserJet 1300/1300n/1300x
HP LaserJet 2100/MTN/ 2200
HP LaserJet 2300
HP LaserJet 2400/2410/2420/2430
HP LaserJet 3015/3020MFP/3030MFP
HP LaserJet 3050MFP/3052MFP/3055MFP
HP LaserJet 3200
HP LaserJet 3300MFP/ 3320/ 3330MFP/ 3380MFP
HP LaserJet 3390MFP/3392MFP
HP LaserJet 4000/ITN/ITN/ 4050
HP LaserJet 4200
HP LaserJet 4250/ 4350
HP LaserJet M1005MFP

ŠIFRA	NAZIV	KAPACITET	BOJA	HP LaserJet 1000w/1005w	HP LaserJet 1010/1012/1015/1018/1020/1022	HP LaserJet 1100/1100A	HP LaserJet 1160	HP LaserJet 1200/1220	HP LaserJet 1320	HP LaserJet 1300/1300n/1300x	HP LaserJet 2100/MTN/ 2200	HP LaserJet 2300	HP LaserJet 2400/2410/2420/2430	HP LaserJet 3015/3020MFP/3030MFP	HP LaserJet 3050MFP/3052MFP/3055MFP	HP LaserJet 3200	HP LaserJet 3300MFP/ 3320/ 3330MFP/ 3380MFP	HP LaserJet 3390MFP/3392MFP	HP LaserJet 4000/ITN/ITN/ 4050	HP LaserJet 4200	HP LaserJet 4250/ 4350	HP LaserJet M1005MFP
000013860	C4092A	2500 str.	crna		●											●						
000012554	C4096A	5000 str.	crna							●												
000013328	C4127A	6000 str.	crna																●			
-	C4127X	10000 str.	crna																●			
000012552	C7115A	2500 str.	crna	●			●										●					
000014634	C9700A	5000 str.	crna																			
000014635	C9701A	4000 str.	plava																			
000014636	C9702A	4000 str.	žuta																			
000014637	C9703A	4000 str.	crvena																			
000014653	C9720A	9000 str.	crna																			
000014654	C9721A	8000 str.	plava																			
000014655	C9722A	8000 str.	žuta																			
000014656	C9723A	8000 str.	crvena																			
000014647	Q6471A	4000 str.	plava																			
000014648	Q6472A	4000 str.	žuta																			
000014649	Q6473A	4000 str.	crvena																			
000013215	Q6511A	6000 str.	crna										●									
000013214	Q7551A	6500 str.	crna																			
000013213	Q7553A	3000 str.	crna																			
000014650	Q7581A	6000 str.	plava																			
000014651	Q7582A	6000 str.	žuta																			
000014652	Q7583A	6000 str.	crvena																			
000018763	CE285A	1600 str.	crna																			
000018764	CE278A	2100 str.	crna																			
000030443	CF226A	3100 str.	crna																			
000031205	CF279A	1000 str.	crna																			
000024656	CF280A	2700 str.	crna																			
000028581	CF280X	6900 str.	crna																			
000024668	CF283A	1500 str.	crna																			
000033447	CE505X	6500 str.	crna																			



ZA SAMSUNG PRINTERE

ML 1010/1020
ML 1210/1220/1250
ML 1410
ML 1430
ML 1440/1450/1451
ML 1510/1710/1750
ML 1610
ML 1640/2240
ML 1710/1740/1750
ML 2010/2510
ML 2550/2551/2552
ML 2570/2571
ML 2850D/2851ND
ML 3000
ML 3050/3051
ML 6040/6060
SCX 4016
SCX 4116
SCX 4200
SCX 4216/4216F
SCX 4521

ŠIFRA	NAZIV	KAPACITET	BOJA	ML 1010/1020	ML 1210/1220/1250	ML 1410	ML 1430	ML 1440/1450/1451	ML 1510/1710/1750	ML 1610	ML 1640/2240	ML 1710/1740/1750	ML 2010/2510	ML 2550/2551/2552	ML 2570/2571	ML 2850D/2851ND	ML 3000	ML 3050/3051	ML 6040/6060	SCX 4016	SCX 4116	SCX 4200	SCX 4216/4216F	SCX 4521
000013218	ML-1210D3	3000	crna	●	●		●																	
000013219	ML-1610D2	2000	crna							●														
000013220	ML-1710D3	3000	crna			●			●			●					●							
000013221	ML-2010D3	3000	crna										●		●									
000012558	ML-2550D5	10000	crna											●										
000012559	ML-6060D6	6000	crna					●											●					
000014945	ML-D2850B	5000	crna													●								
000013222	ML-D3050A	4000	crna															●						
000013760	MLT-D1082S	1500	crna							●														
000013224	SCX-4216D3	3000	crna																	●	●		●	
000014946	SCX-4521D3	3000	crna																					●
000013223	SCX-D4200A	3000	crna																			●		
000024657	MLT-D101S	1500 str.	crna																					
000024670	MLT-D103S	1500 str.	crna																					
000024684	MLT-D1042S	1500 str.	crna																					
000033443	ML-1910	2500 str.	crna																					
000033448	ML2010U	3000 str.	crna																					
000033445	MLT-D104S	1500 str.	crna																					
000033449	MLT-D1052L	2500 str.	crna																					
000033444	MLT-D111S	1000 str.	crna																					



olivetti

 za uređaje:
 - OLIVETTI
 - PANASONIC
 - SILVER REED
 - ALCATEL
 - NANTIAN

ZA UREĐAJ

OLIVETTI ET 121, 201, 221, 231

PANASONIC KX-E 500, KX-E 700M

SILVER REED EX-200, EX 300

OLIVETTI WORDCART

ALCATEL 9353

OLIVETTI PR 50, 54, 60

ALCATEL 9353

OLIVETTI PR 50, 54, 60

OLIVETTI PR-2

NANTIAN PR-2, K10

OLIVETTI PR-2

NANTIAN PR-2, K10

OLIVETTI ETP 55, 65, 66, 510

OLIVETTI LIGHTCART, SLIMCART

OLIVETTI ONDACART

ŠIFRA	NAZIV	BOJA	PROIZVOĐAČ	OLIVETTI ET 121, 201, 221, 231	PANASONIC KX-E 500, KX-E 700M	SILVER REED EX-200, EX 300	OLIVETTI WORDCART	ALCATEL 9353	OLIVETTI PR 50, 54, 60	ALCATEL 9353	OLIVETTI PR 50, 54, 60	OLIVETTI PR-2	NANTIAN PR-2, K10	OLIVETTI PR-2	NANTIAN PR-2, K10	OLIVETTI ETP 55, 65, 66, 510	OLIVETTI LIGHTCART, SLIMCART	OLIVETTI ONDACART
000001327	GR165C	crna	FULLMARK	●	●	●												
000000644	ET 2200 313C	crna	FULLMARK				●											
000003971	N983	crna ili crvena	FULLMARK					●	●									
000001371	PR 50	crna ili crvena	OLIVETTI						●	●								
000001857	PR 2	crna	OLIVETTI								●	●						
000001094	N186BK	crna	FULLMARK										●	●				
000000472	GR177C	crna	OLIVETTI												●	●	●	
000024443	DM 524	crna	OLIVETTI															●

EPSON

 za uređaje:
 - EPSON
 - CANON
 - SEIKO
 - SHARP
 - CASIO
 - SANYO
 - OMORON
 - NCR
 - NORAD
 - FUJITSU
 - CITIZEN

ZA UREĐAJ

EPSON 8000, 8500

EPSON DFX 5000, 5000+

CANON, CASIO, CITIZEN, SHARP

SEIKO 600, VICTOR 600

EPSON ERC-02II

SHARP ER 2300, ER 4230

EPSON ERC 03

CASIO 3205, 3808, 4000

EPSON ERC 05

EPSON M150, M160, M185

EPSON ERC 09, HX20

SHARP 5200, 5210

SANYO ERC 7000, 7100

EPSON ERC 11

SHARP 5200, 5210

SANYO ERC 7000, 7100

EPSON ERC 11

ŠIFRA	NAZIV	BOJA	PROIZVOĐAČ	EPSON 8000, 8500	EPSON DFX 5000, 5000+	CANON, CASIO, CITIZEN, SHARP	SEIKO 600, VICTOR 600	EPSON ERC-02II	SHARP ER 2300, ER 4230	EPSON ERC 03	CASIO 3205, 3808, 4000	EPSON ERC 05	EPSON M150, M160, M185	EPSON ERC 09, HX20	SHARP 5200, 5210	SANYO ERC 7000, 7100	EPSON ERC 11	SHARP 5200, 5210	SANYO ERC 7000, 7100	EPSON ERC 11
000001406	N884BK	crna	FULLMARK	●	●															
000006314	N267BK	crna/crvena ili crna	FULLMARK			●	●	●												
000006267	N274BK	crna ili crvena	FULLMARK						●	●	●									
000007247	N294BK	crna ili crvena	FULLMARK									●								
000006268	N363BK	crna ili crvena	FULLMARK										●	●						
000000540	107547200	crna ili crvena	EPSON											●	●	●				
000006233	N443BK	crna ili crvena	FULLMARK															●	●	●
000003203	N785BK	crna ili crvena	FULLMARK																	
000002493	N978BK	crna ili crvena	FULLMARK																	
000006109	N832BK	crna ili crvena ili crno/crveno	FULLMARK																	
000000906	N908BK	crna ili crvena	FULLMARK																	
000004897	N966BK	crna ili crvena	FULLMARK																	
000000561	S015231	crna ili crvena	EPSON																	
000007285	N992BK	crna ili crvena	FULLMARK																	
000007955	N533PE	crna ili crvena	FULLMARK																	
000005298	N618BK	crna	FULLMARK																	
000016842	S015327	crna	EPSON																	
000000439	S015329	crna	FULLMARK																	
000003503	S015329	crna	EPSON																	
000000477	N478BK	crna	FULLMARK																	
000004667	S015022	crna	EPSON																	
000001611	N177BK	crna	FULLMARK																	



za uređaje:
 - STAR
 - DATAMEGA
 - IBM

ZA UREĐAJ

ŠIFRA	NAZIV	BOJA	PROIZVOĐAČ	STAR LC 2410, LC-15	STAR NX 2400, 2420	STAR XB 24-10/15, XR 1000/1500	STAR NL, NX 10	STAR NB 24-10, N-24-10	STAR MICRONICS SP200, MP200	STAR MICRONICS SP-212FC	DATAMEGA SP216	STAR MICRONICS SP200, MP200	STAR MICRONICS SP-212FC	DATAMEGA SP216	STAR SP 300, 312	STAR SP 342, 349	IBM 9068 Bk	IBM 6500
00000476	GR691	crna	STAR	●	●	●												
000007727	GR686	crna	STAR				●	●										
000001725	SP 200	crna ili crvena	STAR						●	●	●							
000001232	N179BK	crna ili crvena	FULLMARK								●	●	●					
000000231	N948BK	crna ili crvena	FULLMARK											●	●			
000023235	IBM 9068 Bk	crna	PRINT RITE														●	
000023680	IBM 6500	crna	INFOPRINT															●
000023748	LB300	crna	DATAPRINT															●

OMRON RS 5510, 8500																			
EPSON ERC 18																			
CASIO TK 2100, 4000, 4200																			
CASIO TK-810																			
NCR 2020																			
NORAD 4805																			
SHARP ER 3210																			
SANYO ERC 590, 595																			
EPSON ERC 23																			
FUJITSU GS 800, GS 840																			
EPSON ERC 27																			
EPSON CTM 290, M 290, TM 290																			
EPSON TM 930																			
EPSON ERC 31																			
EPSON TM 930																			
EPSON ERC 31																			
SHARP ER 3550																			
EPSON ERC 32, TM 935																			
CASIO TK 1300, 6000, 7000																			
CASIO CE4700, 6100, 7000																			
EPSON ERC 37																			
EPSON FX-2190, FX-2190N																			
EPSON FX-2190, FX-2190N																			
EPSON FX-890, FX-890N																			
EPSON FX-890, FX-890N																			
EPSON LQ 1000, 1010, 1050																			
EPSON ERC 20																			
CITIZEN TRIBUTE 224																			
EPSON LQ 1000, 1010, 1050																			
EPSON ERC 20																			
CITIZEN TRIBUTE 224																			
EPSON LQ 2070, 2080																			
EPSON LQ 2170, 2180																			

EPSON®

Fullmark®
IMAGING & COMPUTER SUPPLIES

za uređaje:

- EPSON
- CANON
- SEIKO
- SHARP
- CASIO
- SANYO
- OMORON
- NCR
- NORAD
- FUJITSU
- CITIZEN

ZA UREĐAJ

EPSON ERC-05	EPSON LQ 2070, 2080	EPSON LQ 2170, 2180	EPSON LQ 630, 630S	EPSON LQ 670, 680, 860	EPSON LQ 2550	EPSON LQ 2500	EPSON LQ 670, 680, 860	EPSON LQ 2550	EPSON LQ 2500	EPSON LQ 300, 500, 570, 800, 850	EPSON ERC 19	CITIZEN TRIBUTE 124	EPSON LQ 300, 500, 570, 800, 850	EPSON ERC 19	CITIZEN TRIBUTE 124
--------------	---------------------	---------------------	--------------------	------------------------	---------------	---------------	------------------------	---------------	---------------	----------------------------------	--------------	---------------------	----------------------------------	--------------	---------------------

ŠIFRA	NAZIV	BOJA	PROIZVOĐAČ												
000026427	ERC-05B	crna	EPSON	●											
00000301	S015086	crna	EPSON		●	●									
000005299	N611BK	crna	FULLMARK			●									
000005128	N9013BK	crna	FULLMARK				●	●	●						
00000302	S015016	crna	FULLMARK						●	●	●				
00000402	N477BK	crna	FULLMARK							●	●	●			
00000723	S015021	crna	EPSON										●	●	●



Lexmark™

Fullmark®
IMAGING & COMPUTER SUPPLIES

za uređaje:

- CITIZEN
- COMMODORE
- OLIMPIA
- LEXMARK

ZA UREĐAJ

CITIZEN 120D, 180D, GSX-140	CITIZEN GSX 190, 340, Swift 24	COMMODORE MPS 1200	CITIZEN DP 600 serija	CITIZEN IDP-3530, 3540, 3541	CITIZEN IR-61	CITIZEN MD 910, 911	CITIZEN IDP-3110	OLIMPIA CM-888	OLIMPIA 72i	Lexmark 2380/2381/2391/2580/2581/2590/2591/2490/2500	Lexmark 4227
-----------------------------	--------------------------------	--------------------	-----------------------	------------------------------	---------------	---------------------	------------------	----------------	-------------	--	--------------

ŠIFRA	NAZIV	OZNAKA	BOJA	PROIZVOĐAČ								
00000012	N488BK		crna	FULLMARK	●	●	●					
000003553	N880BK		crna	FULLMARK			●	●	●			
000003578	N178PE		crna ili crvena	FULLMARK					●	●	●	
000024465	OLYMPIA 72i		crna	OLYMPIA					●			
000022858	3070166	2XXX	crna	LEXMARK						●		
000022458	13L0034		crna	LEXMARK							●	

